

**price list**

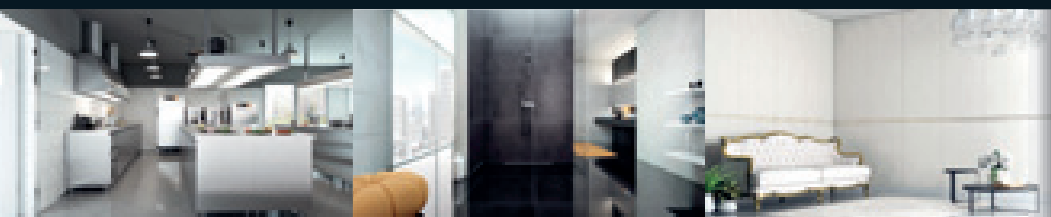

**catalogue**

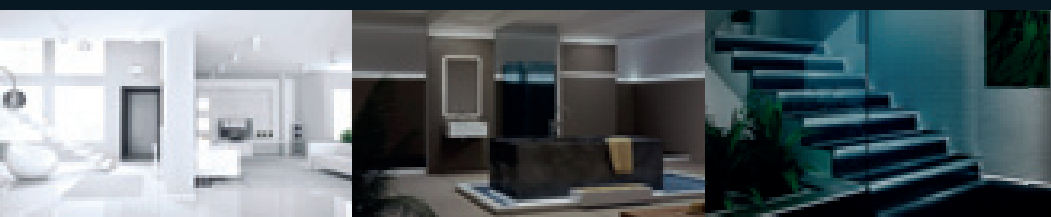

**prices**

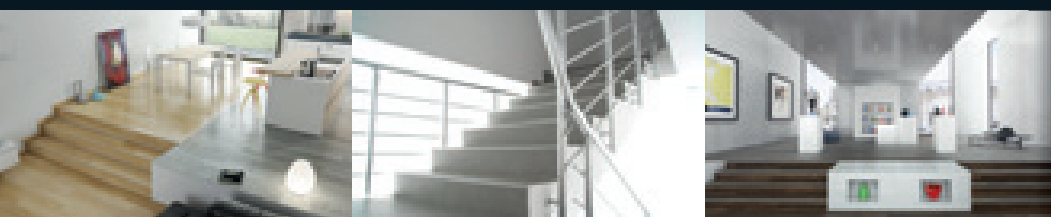

**2022\_02**

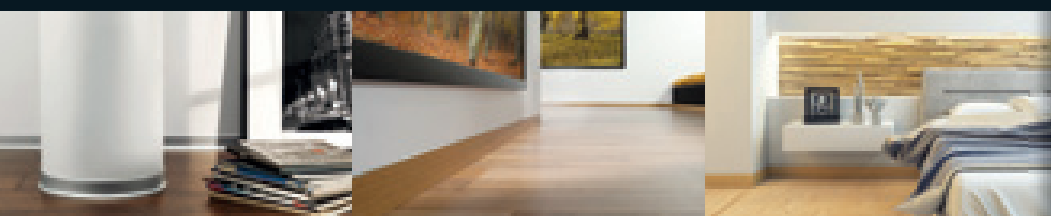



**price list**

**catalogue**

**prices**

**2022\_02**

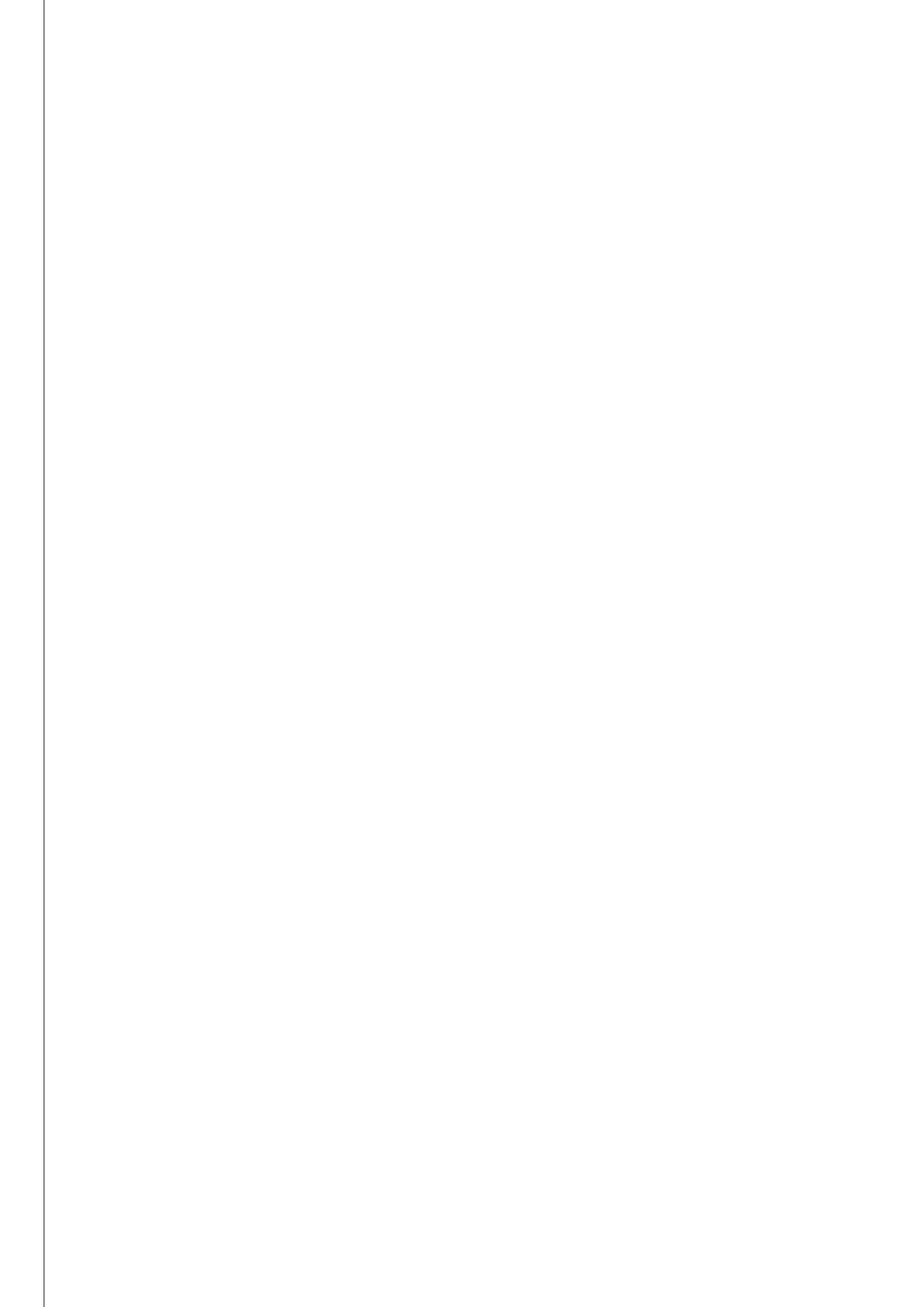

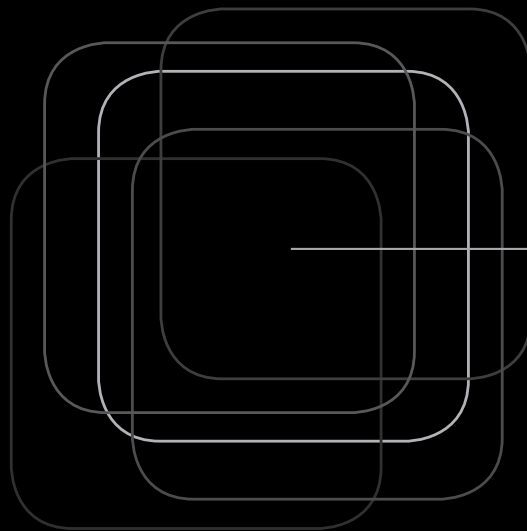



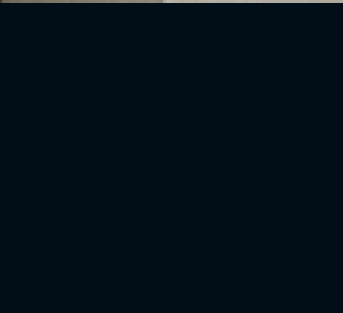
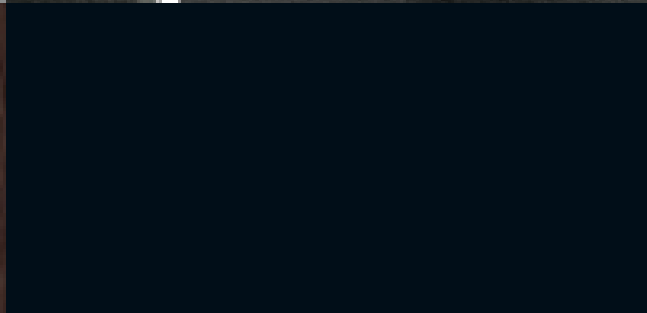
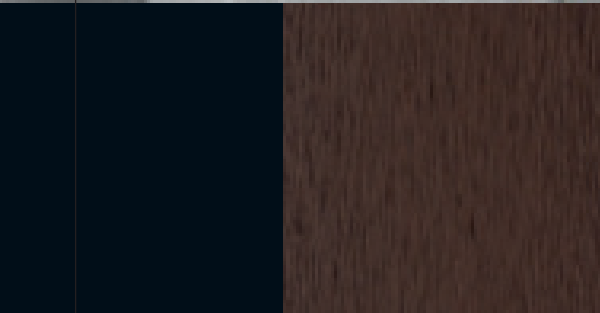
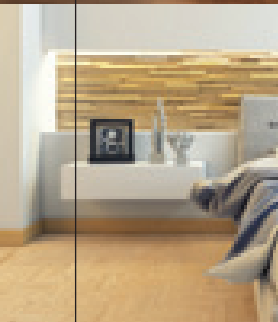
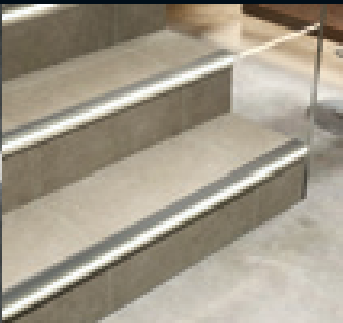





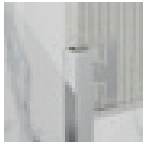





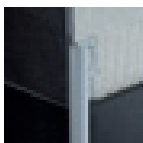

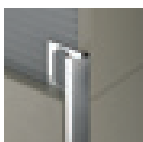

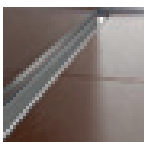



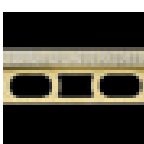

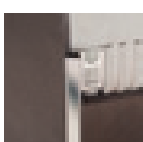
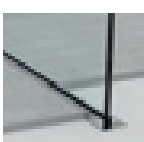
**Design is our best profile.**

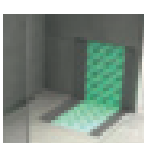
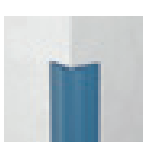

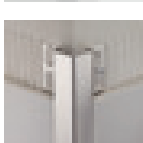
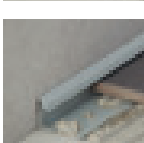

# Index

external corners profiles		CERFIX® PROANGLE Q page 18		CERFIX® PROTOP page 47		PROROUND B page 62		
		CERFIX® PROANGLE page 26						
		CERFIX® PROTRIM IP page 31	listellos and decorative profiles		CERFIX® PROLIST page 50	linear drains and bathroom systems		PP DRAIN AQUA page 68
		CERFIX® PROTRIM page 32			METAL LINE AF - M DESIGN page 51			THIN DRAIN page 73
		CERFIX® PROTRIM N page 35			CERFIX® PROLIST-X DESIGN page 51			SLIM DRAIN page 75
		CERFIX® PROANGLE F page 40			CERFIX® PRODECOR - C DESIGN page 52			SMART DRAIN page 77
		CERFIX® PROANGLE AX - M DESIGN page 41			CERFIX® PROSTYLE - C DESIGN page 52			Q DRAIN page 79
		CERFIX® PRONIVEL M page 41						GLASS PROFILE page 82
	PROCORNER M page 42	internal corners profiles			CERFIX® PROROUND M page 56			WPSTOP page 90
	PROCORNER P page 44				CERFIX® PROROUND P page 59			SANIBORD page 92
	PVC LINE 8610- 8611 page 45			CERFIX® PROROUND M GIC/ page 60				
	CERFIX® PROBORD page 46			CERFIX® PROINT page 60-61	profiles for floors of same height		CERFIX® PROANGLE page 96	





CERFIX®  
PROANGLE B  
page 97



CERFIX®  
PROANGLE  
FLEX  
page 98



CERFIX®  
PRODECOR DJ  
page 99



CERFIX®  
PRODECOR DJ  
FLEX  
page 99



CERFIX®  
PRODECOR  
page 99



CERFIX®  
PROSTYLE  
page 100



PROJOINT U  
page 101



PROJOINT  
page 101



PROJOINT T  
page 102



PROJOINT R  
page 104



PROJOINT M  
page 104



PROCLASSIC R  
page 105



PROCLASSIC F  
page 108

profiles for  
floors of  
different  
height

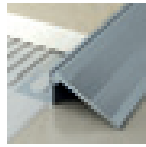

CERFIX®  
PRONIVEL N  
page 112



CERFIX®  
PRONIVEL P  
page 113



CERFIX®  
PRONIVEL L  
page 114



CERFIX®  
PRONIVEL PB  
page 114



CERFIX®  
PRONIVEL  
FLEX  
page 115



CERFIX®  
PRONIVEL M  
page 115



PROLEVEL  
HIGH  
page 116

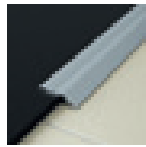

PROLEVEL  
MEDIUM  
page 118



PROLEVEL  
THIN  
page 119

movement  
joints



CERFIX®  
PROJONT  
DIL NE  
page 122



CERFIX®  
PROJONT  
DIL NJ  
page 122



CERFIX®  
PROJONT  
DIL NL  
page 123

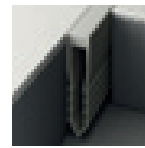

CERFIX®  
PROJONT  
DIL NF  
page 123



CERFIX®  
PROJONT DIL  
NAN  
page 124



CERFIX®  
PROJONT DIL  
NPAN  
page 124



CERFIX®  
PROJONT DIL  
NIN  
page 125



CERFIX®  
PROJONT DIL  
NIL  
page 125



CERFIX®  
PROJONT DIL  
NTA - NTI - NTO  
page 126

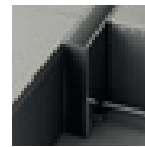

CERFIX®  
PROJONT DIL  
STA - STI  
page 126



CERFIX®  
PROJONT DIL  
NZA  
page 127



CERFIX®  
PROJONT DIL  
NZS  
page 127

# Index



CERFIX®  
PROJOINT DIL  
PBE  
page 128



CERFIX®  
PROJOINT DIL  
PBH  
page 129



CERFIX®  
PROJOINT DIL  
PAS  
page 129



CERFIX®  
PROJOINT DIL  
PHDE  
page 130



CERFIX®  
PROJOINT DIL  
PFFE  
page 130



CERFIX®  
PROCOVER  
FLEX  
page 131

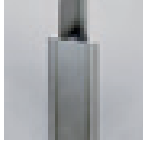

CERFIX®  
PROCOVER FIX  
page 131



CERFIX®  
PROCOVER  
page 132

## profiles for balconies and terraces



CERFIX®  
PROTEC CPCV  
- CPCI  
page 140

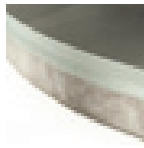

CERFIX®  
PROTEC CPCVF  
page 140



CERFIX®  
PROTEC  
CPCV/30/  
page 142



CERFIX®  
PROTEC CPNV  
page 143



CERFIX®  
PROTEC CPNVF  
page 143



CERFIX®  
PROTEC CPGV  
page 144

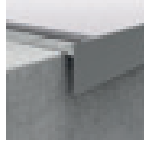

CERFIX®  
PROTEC CPQV  
page 145



CERFIX®  
PROTEC CPEV  
- CPEI  
page 146



CERFIX®  
PROTEC CPHA  
- CPHV  
page 148



CERFIX®  
PROTEC CPLB  
- CPLV  
page 149



CERFIX®  
PROSTEP SMA  
- SM  
page 152



CERFIX®  
PROTRIM IP  
page 153



CERFIX®  
PROSTEP SNG  
- SN  
page 153



CERFIX®  
PROSTEP SAR  
- SIR  
page 154

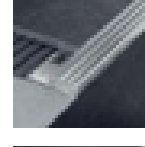

CERFIX®  
PROSTEP SIS  
page 155

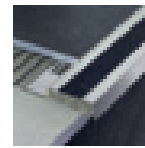

CERFIX®  
PROSTEP SIX  
page 155



CERFIX®  
PROSTEP  
WOOD  
page 156



CERFIX®  
PROSTEP SP  
page 156



CERFIX®  
PROSTEP SA  
- SB  
page 157

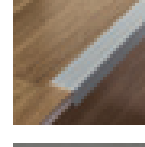

PROTECT  
page 158

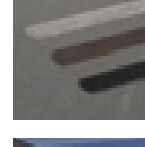

SAFETY-STEP  
page 166

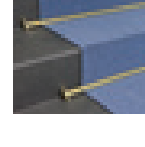

PROSTAIR  
page 168

## waterproofing, drainage, uncoupling



WPSTOP  
page 136

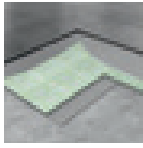

WPSTOP 3  
page 137

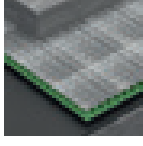

WPSTOP  
DRAIN 10  
page 137

## stair nosing profiles



CERFIX®  
PROSTEP SGA -  
SGI - SGN - SGK  
page 152

profiles for  
wooden,  
laminate  
and LVT  
floors



UNISYSTEM  
PLUS  
page 174

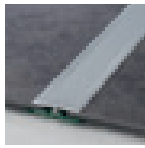

PROFIXTHIN  
page 180



PRESTWOOD  
page 182



RC  
page 185



TERMINAL  
FLEX  
page 185

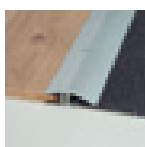

ALFIX 616  
page 186



ALFIX 46  
page 187



CERFIX®  
PROJOINT DIL  
page 188



CERFIX®  
PRONIVEL PB  
page 188-189



CERFIX®  
PROJOINT T  
page 189



CERFIX®  
PROSTEP  
page 190

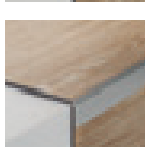

PROTECT  
page 190



CERFIX®  
PROTRIM  
page 191



CERFIX®  
PROANGLE  
page 191



CERFIX®  
PROANGLE Q  
page 191



CERFIX®  
PROROUND M  
page 192



CERFIX®  
PROINT  
page 192

metal line

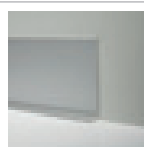

METAL LINE 90  
page 198



METAL LINE 90  
TREND COLOR  
page 198

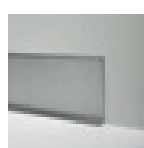

METAL LINE  
790  
page 200



METAL LINE 92  
page 201



METAL LINE 93  
page 201

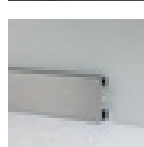

METAL LINE 89  
page 202



METAL LINE 89  
TREND COLOR  
page 202

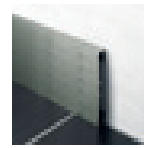

METAL LINE 89  
I DESIGN  
page 203

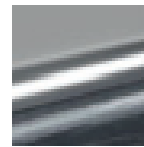

PROLIGHT  
METAL LINE 89  
page 203

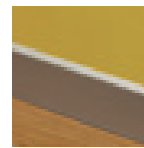

METAL LINE  
89/613  
page 204



METAL LINE  
105  
page 205



METAL LINE  
87 - 88  
page 206

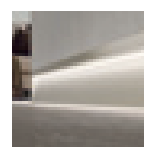

PROLIGHT  
METAL LINE S  
SKL/2  
page 207



METAL LINE AF  
- M DESIGN  
page 207



METAL LINE  
100  
page 208

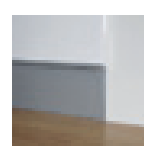

METAL LINE  
101  
page 208

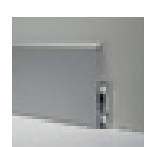

METAL LINE 95  
page 209



METAL LINE 98  
page 210

# Index

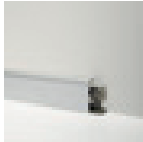

**METALLINE**  
97/4  
page 211

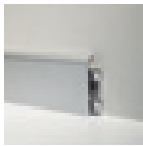

**METALLINE**  
97/7  
page 212



**METALLINE**  
97/8  
page 213

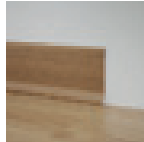

**PVC LINE 8600**  
page 221

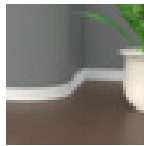

**PVC LINE 8181**  
page 221

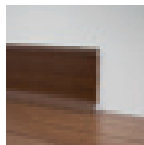

**PVC LINE 8596**  
- 8598  
page 222

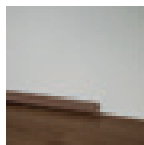

**PVC LINE 8580**  
- 8582  
page 222



**PVC LINE 8602**  
page 223

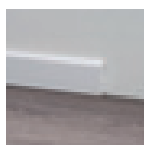

**PVC LINE 8603**  
page 224

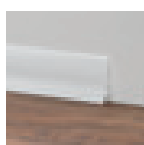

**PVC LINE 8607**  
page 225



**PVC LINE 148 -**  
172 - 173  
page 226



**PVC LINE 170 -**  
169 - 171  
page 227

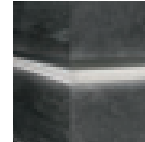

**PROLIGHT**  
PROLIST Q LQL  
page 232

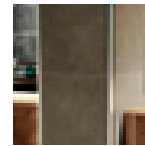

**PROLIGHT**  
PROANGLE Q  
ZQAL  
page 233



**PROLIGHT**  
PROSTEP  
SGA/11L  
page 234

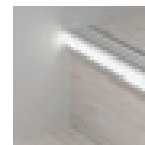

**PROLIGHT**  
PROTECT G/9/F  
page 234

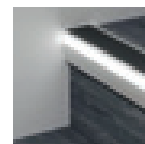

**PROLIGHT**  
PROTECT  
126/L/F  
page 235

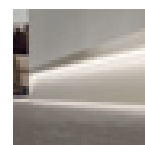

**PROLIGHT**  
METAL LINE S  
SKL/2  
page 236



**PROLIGHT**  
METAL LINE  
87/88  
page 237

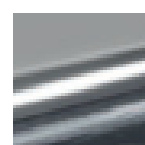

**PROLIGHT**  
METAL LINE 89  
page 238



**COMPONENTI**  
ELETTRICI  
page 240

**pvc line**



**PVC LINE 8605**  
page 216



**PVC LINE 8606**  
page 216

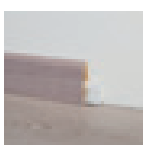

**PVC LINE 8608**  
page 217



**PVC LINE 8615**  
page 218



**PVC LINE 8616**  
page 218



**PVC LINE 8613**  
page 219

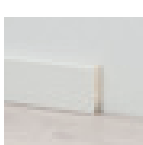

**PVC LINE 8612**  
page 220



**PVC LINE 8614**  
page 220

**prolight**



**PROLIGHT**  
PROLIST LLA  
- LLB  
page 230



**PROLIGHT**  
PROLIST TLA  
- CLA  
page 231



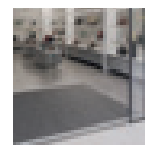



**technical  
entrance  
mats**







**PROMAT**  
page 245

supports for raised floors		PP LEVEL DUO® COMPLETE SUPPORT page 249		FIVE page 264	
		PP LEVEL DUO® MODULAR SUPPORT page 250		SPACERS WEDGES page 265	
		PP LEVEL DUO® DOUBLE JOIST SYSTEM page 253		ACCESSORIES FOR INSTALLATION page 266	
		PP LEVEL FIX COMPLETE SUPPORT page 254		PROFLEX MACHINE page 267	
		PP LEVEL MINI page 255			
		SP1 page 255	DIY profiles		DIY PROFILES page 270
		PP LEVEL - ACCESSORIES page 256			
		CERFIX® PROTEC CPLB - CPLV page 257	merchandising for the point of sale		MERCHANDISING FORTHEPOINT OFSALE page 278
accessories for installation		PROTILER page 261	index by item	page	
		FIX LEVEL page 262			
		KLIC LEVEL page 263			

## stainless steel

-  **SS**  
polished stainless steel  
AISI 304 DIN 1.4301
-  **SS3**  
polished stainless steel  
AISI 316 DIN 1.4404
-  **SS0**  
polished stainless steel  
AISI 430 DIN 1.4016
-  **SSP**  
superpolished stainless steel  
AISI 304 DIN 1.4301
-  **SSS**  
satin stainless steel  
AISI 304 DIN 1.4301
-  **SSB**  
sandblasted stainless steel  
AISI 304 DIN 1.4301
-  satin stainless steel  
AISI 430 - DIN 1.4016













## brass

-  **BN**  
natural
-  **BP**  
polished
-  **BCP**  
plated polished
-  **BCG**  
24kt gold plated

## aluminium

-  **AN**  
natural

## anodised aluminium

-  **AS**  
silver
-  **AG**  
gold
-  **ASG**  
sand gold
-  **AT**  
titanium
-  **AB**  
bronze
-  **ABE**  
bronze elox
-  **ABL**  
black
-  platinum
-  titanium
-  brown
-  dark brown
-  carbon

## bright polished aluminium

-  **ABPS**  
silver

-  **ABPG**  
gold

-  **ABPT**  
titanium

-  **ABPC**  
copper

## bright satin aluminium

-  **ABSS**  
silver

-  **ABSG**  
gold

-  **ABST**  
titanium

-  **ABSG**  
copper

-  **ABSB**  
black

## bright scratched aluminium

-  **ABBS**  
silver

## colour-coated aluminium

-  **AC RAL 9003**  
matt white

-  **AC RAL 9003**  
white

-  **AC RAL 9010**  
matt white

-  **AC RAL 9010**  
polished white

-  **AC RAL 8019**  
dark brown

-  **AC RAL 7038**  
ash grey

-  **AC RAL 7038**  
ash grey embossed

-  **AC RAL 9006**  
metal grey

-  **AC RAL 9007**  
aluminium grey

-  **AC anthracite grey**

-  **AC rust**

-  **AC ancient grey**

-  **AC beige**

-  **AC sand**

-  **AC greige**

-  **AC stone**

-  **AC grey**

-  **AC bronze**

-  **AC dark brown**

-  **AC white ST**

-  **AC black ST**

-  **AC concrete white**

-  **AC concrete graphite**

-  **AC concrete smoke**

-  **AC concrete mud**

-  **AC concrete sand**

-  **AC metal dark**

-  **AC metal light**

-  **AC solid white**

## decors Alcom® Plus

-  02

-  05

-  08

-  10

-  11

-  12

-  13

-  14

-  18

-  19

-  20

-  25

-  26

-  31

-  32

-  34

-  35

-  36

-  37

-  38

-  39

-  40

-  41

-  42

-  43

-  44

-  47

-  65

-  71

-  72

-  73

-  74

-  76

-  77

-  78

-  79

-  80

-  81

-  89

-  91

-  92

-  93

-  94

-  95

-  351

-  363

-  372

-  490

	560
	580
	590
	665
	670
	951
	975
	1003
	1006
	1009
	1012
	1021
	1024
	1030
	1033
	1036
	1042
	1045
	1051
	1054
	1057
	1060
	1063
	1066
	1069
	1081
	1084
	1090
	1093
	1096

	1099
	1102
	1105
	1108
	1111
	1202
	1203
	1204
	1205
	1206
	1207
	1208
	1209
	1210
	1211
	1212
	1213
	1214
	1215
	1216
	1217
	96 - embossed white RAL 9010
	97 - embossed black RAL 9005
	99 - satin silver
	100 - satin steel
<b>solid wood</b>	
	natural oak
<b>PVC</b>	
	code 400 snow white
	code 402 white

	code 404 9001 cream white
	code 406 RAL 1015 - ivory
	code 408 RAL 1019 - beige grey
	code 410 RAL 7030 - stone grey
	code 412 RAL 7038 - ash grey
	code 414 RAL 7035 - light grey
	code 416 anthracite
	code 418 blue
	code 420 pastel blue
	code 422 light green
	code 424 RAL 3002 - red
	code 426 RAL 9005 - black
	code 428 RAL 1023 - yellow
	code 430 pastel pink
	code 432 beige bahama
	code 434 peach
	code 436 caramel
	code 438 brown
	code 440 dark brown
	code 442 coral red
	code 444 raw sienna
	code 446 terracotta
<b>foam PVC</b>	
	decor 518
	decor 520
	decor 524
	decor 525
	decor 528
	decor 530
	decor 531

	decor 532
	decor 533
	decor 534
	decor 536
	decor 540
	decor 542
	decor 544
	decor 545
	decor 555 white
	decor 556 light grey
	decor 557 black
	decor 558 anthracite
	decor 559 grey
	decor 561 yellow
	decor 562 green
	decor 563 light blue
	decor 564 red







## external corners profiles

A line dedicated to the protection and finishing of outside corners of the wall tiles. Profiles are suitable for any type of environment for the variety of finishes available, matching perfectly with all types of ceramics and giving character to the compositions and linearity.

## cerfix® proangle Q

Proangle Q in aluminium is a line of universal profiles with square shape, specially designed to edge and protect the external corners of ceramic coverings, that can be also used for finishing worktops and platforms. ZQVNH/ boasts the certified antibacterial technology (according to the internationally recognized laboratory test JIS Z 2801:2000) which reduces the presence of the most dangerous bacteria up to 99%, thus assuring the best hygiene over time.



ZQBN/10 bright polished silver aluminium

### PROANGLE Q

length = 270 cm - pack 20 pcs

		H						
ART.	finishing	4,5	6	8	9	10	11	12,5
<b>ALUMINIUM</b>								
ZQAN/	silver anodised	88772	88875	88876	88877	88878	88879	88880
	<i>euro/m</i>	4,53	4,53	4,53	4,73	4,89	5,25	5,57
ZQAN/	titanium anodised	88902	88903	88904	88905	88906	88907	88908
	<i>euro/m</i>	5,16	5,16	5,16	5,36	5,52	5,88	6,20
ZQAN/	black anodised	-	-	89205	-	89206	89207	89208
	<i>euro/m</i>	-	-	8,39	-	8,58	8,94	9,24
ZQBN/	bright polished silver	88816	88919	88920	88921	88922	88923	88924
	<i>euro/m</i>	7,54	7,54	7,54	7,93	8,33	8,85	9,38
ZQBN/	bright polished gold	88933	-	88935	-	88937	-	88939
ZQTN/	bright polished titanium	88949	88950	88951	88952	88953	88954	88955
ZQBRN/	bright polished copper	-	-	-	-	88969	-	88971
	<i>euro/m</i>	7,93	7,93	7,93	8,35	8,75	9,31	9,86
ZQBSN/	bright satin silver	88981	88982	88983	-	88985	88986	88987
	bright satin gold	88997	-	88999	-	89001	-	89003
ZQTMN/	bright satin titanium	89013	89014	89015	-	89017	-	89019
ZQBRSN/	bright satin copper	-	-	89031	-	89033	-	89035
	<i>euro/m</i>	8,78	8,78	8,78	-	9,57	10,31	10,66
ZQBSN/	bright satin black	-	-	-	-	89209	89210	89211
	<i>euro/m</i>	-	-	-	-	11,97	12,73	13,09
ZQAGN/	bright scratched silver	89061	-	89063	-	89065	-	89067
	<i>euro/m</i>	12,02	-	12,02	-	12,82	-	13,62
<b>COLOUR-COATED ALUMINIUM</b>								
ZQVN/	colour-coated matt white RAL 9003	-	-	89200	-	89202	89203	89204
	colour-coated white RAL 9003	89077	89076	89079	-	89081	89078	89083
	<i>euro/m</i>	5,68	5,68	5,68	-	6,18	6,46	6,68
<b>ANTIBACTERIAL COLOUR-COATED ALUMINIUM</b>								
ZQVNH/	colour-coated white RAL 9003	-	-	89080	-	89082	-	89084
	<i>euro/m</i>	-	-	7,41	-	7,97	-	8,47

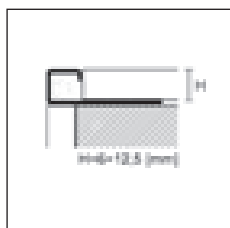
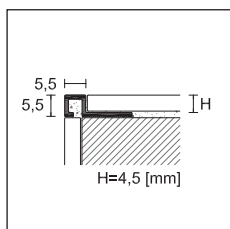

ZQAN/10 black anodised aluminium















Complete the article code with H measure (for example ZQAN/ for H=8 becomes ZQAN/8)

Items ZQVN available in different colours on demand minimum quantity 540 meters for colour

For a single piece, see sales conditions on page 288



## PROANGLE Q - OUTSIDE / INSIDE CORNERS / END CAPS

pack 5 pcs*		H							
ART.	finishing	4,5	6	8	9	10	11	12,5	
<b>ALUMINIUM</b>									
ZQAN/ /EI	silver anodised		88809	88882	88883	88884	88885	88886	88887
	titanium anodised		88910	88911	88912	88913	88914	88915	88916
	<i>euro/pc</i>		<b>4,98</b>	<b>4,98</b>	<b>4,98</b>	<b>4,98</b>	<b>4,98</b>	<b>4,98</b>	<b>4,98</b>
ZQAN/ /EI	black anodised		-	-	89223	-	89224	89225	89226
	<i>euro/pc</i>		-	-	<b>5,93</b>	-	<b>5,93</b>	<b>5,93</b>	<b>5,93</b>
ZQBN/ /EI	bright polished silver		88829	88926	88927	88928	88929	88930	88931
	bright polished gold		88941	-	88943	-	88945	-	88947
ZQVN/ /EI	colour-coated matt white RAL 9003		-	-	89192	-	89194	89195	89196
	colour-coated white RAL 9003		89085	89086	89087	-	89089	89088	89091
	<i>euro/pc</i>		<b>4,98</b>	<b>4,98</b>	<b>4,98</b>	<b>4,98</b>	<b>4,98</b>	<b>4,98</b>	<b>4,98</b>
ZQTN/ /EI	bright polished titanium		88957	88958	88959	88960	88961	88962	88963
ZQBRN/ /EI	bright polished copper		-	-	-	-	88977	-	88979
ZQBSN/ /EI	bright satin silver		88989	88990	88991	-	88993	88994	88995
	bright satin gold		89005	-	89007	-	89009	-	89011
ZQTMN/ /EI	bright satin titanium		89021	89022	89023	-	89025	-	89027
ZQBRSN/ /EI	bright satin copper		-	-	89039	-	89041	-	89043
ZQBSN/ /EI	bright satin black		-	-	-	-	89227	89228	89229
	<i>euro/pc</i>		<b>5,93</b>	<b>5,93</b>	<b>5,93</b>	<b>5,93</b>	<b>5,93</b>	<b>5,93</b>	<b>5,93</b>
ZQAGN/ /EI	bright scratched silver		89069	-	89071	-	89073	-	89075
	<i>euro/pc</i>		<b>7,90</b>	-	<b>7,90</b>	-	<b>7,90</b>	-	<b>7,90</b>

no partial packaging

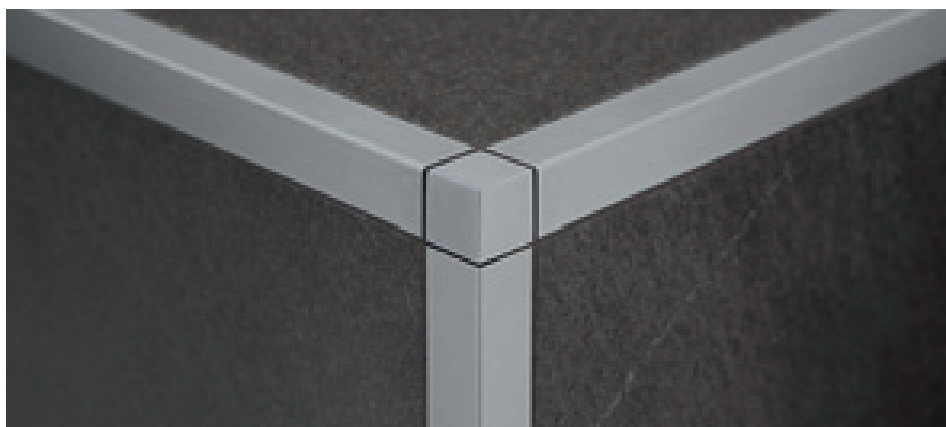

ZQAN/10 + ZQAN/10/EI silver anodised aluminium

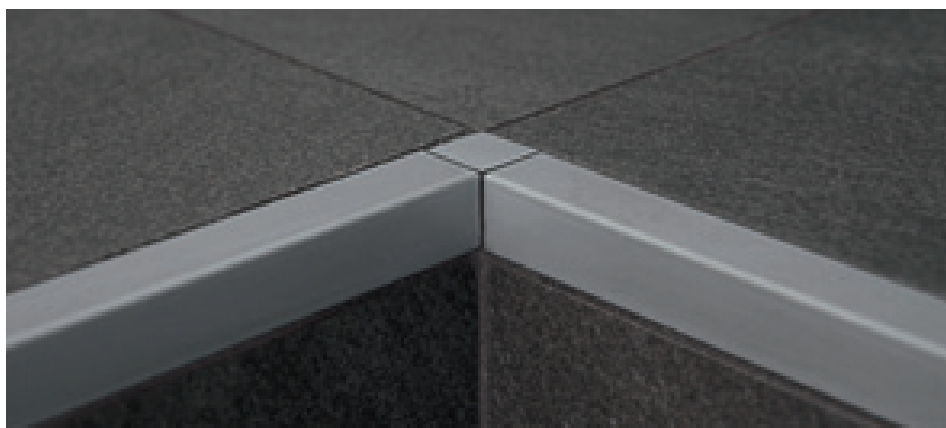

ZQAN/10 + ZQAN/10/EI silver anodised aluminium

Complete the article code with H measure  
(for example ZQAN/ /EI for H=8 becomes  
ZQAN/8/EI)

\* available upon request pack of 1 pc in blister  
+ 1,47 Euro (for example ZQAN/8/EI code 88883  
becomes code 88883/B)

For a single piece, see sales conditions on page 288

## cerfix® proangle Q

Colour-coated aluminium Trend Color Stone: modern finishes with neutral but warm and soft shades which reproduce the heterogeneity of stone thanks to a rough texture.

Colour-coated aluminium Trend Color Concrete: six original cement-effect finishes that recall the typical metropolis colours by revisiting them from a more refined point of view.

Colour-coated aluminium Trend Color Metal: two special metal tonalities which reproduce the iridescent nature of metals.



ZQVN/10 stone colour-coated aluminium

### NEW PROANGLE Q - TREND COLOR

length = 270 cm - pack 20 pcs

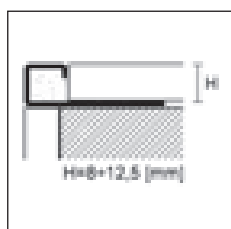

ZQVN/

TREND  
COLOR

		H				
ART.	finishing	8	10	11	12,5	
<b>COLOUR-COATED ALUMINIUM</b>						
<b>TREND COLOR STONE</b>						
	dark brown		89360	89310	89311	89312
	anthracite grey		89093	89095	89106	89097
	ancient grey		89362	89220	89221	89222
	grey		89363	89290	89291	89292
	rust		89094	89096	89107	89098
	bronze		89365	89300	89301	89302
	stone		89366	89280	89281	89282
	greige		89367	89270	89271	89272
	sand		89368	89260	89261	89262
	beige		89369	89250	89251	89252
ZQVN/	white stone		89370	89320	89321	89322
	black stone		89371	89330	89331	89332
<b>TREND COLOR CONCRETE</b>						
	concrete white		-	89131	89161	89181
	concrete graphite		-	89132	89162	89182
	concrete smoke		-	89133	89163	89183
	concrete mud		-	89134	89164	89184
	concrete sand		-	89135	89165	89185
	solid white		-	89138	89168	89188
<b>TREND COLOR METAL</b>						
	metal dark		-	89136	89166	89186
	metal light		-	89137	89167	89187
	<b>euro/m</b>		<b>7,58</b>	<b>7,76</b>	<b>8,07</b>	<b>8,24</b>

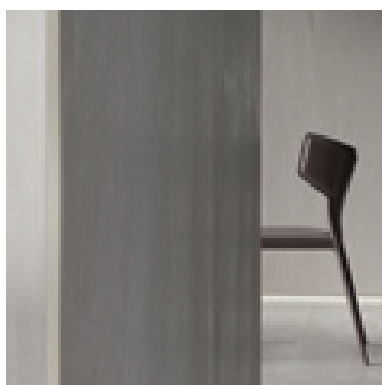

ZQVN/10 concrete white colour-coated aluminium

individually packed - Other heights with TREND COLOR finishes are available upon request, with a minimum of 540 meters.

Complete the article code with H measure (for example ZQVN/ for H=10 becomes ZQVN/10).

For a single piece, see sales conditions on page 288



ZQVN/ /EI  
sand colour-coated  
aluminium

**NEW** PROANGLE Q - TREND COLOR - OUTSIDE / INSIDE CORNERS / END CAPS

pack 5 pcs*		H			
ART.	finishing	8	10	11	12,5
<b>COLOUR-COATED ALUMINIUM</b>					
<b>TREND COLOR STONE</b>					
	dark brown	89380	89303	89304	89305
	anthracite grey	89100	89102	89108	89104
	ancient grey	89382	89213	89214	89215
	grey	89383	89283	89284	89285
	rust	89101	89103	89109	89105
	bronze	89385	89293	89294	89295
	stone	89386	89273	89274	89275
	greige	89387	89263	89264	89265
	sand	89388	89253	89254	89255
	beige	89389	89243	89244	89245
ZQVN/ /EI	white stone	89390	89340	89341	89342
	black stone	89391	89350	89351	89352
<b>TREND COLOR CONCRETE</b>					
	concrete white	-	89392	89402	89410
	concrete graphite	-	89394	89403	89411
	concrete smoke	-	89395	89404	89412
	concrete mud	-	89396	89405	89413
	concrete sand	-	89397	89406	89414
	solid white	-	89400	89409	89417
<b>TREND COLOR METAL</b>					
	metal dark	-	89398	89407	89415
	metal light	-	89399	89408	89416
	<i>euro/pc</i>	<b>6,10</b>	<b>6,10</b>	<b>6,10</b>	<b>6,10</b>

no partial packaging

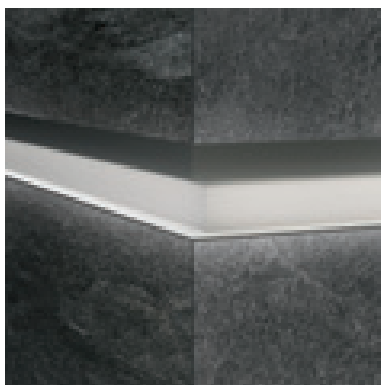

LED-light profiles and skirting boards with Trend Color finishes on page 232 and 236.

Complete the article code with H measure (for example ZQVN/ /EI per H = 10 becomes ZQVN/10/EI).

\* available upon request pack of 1 pc in blister + 1,47 Euro (for example ZQVN/10/EI code 89303 becomes 89303/B).

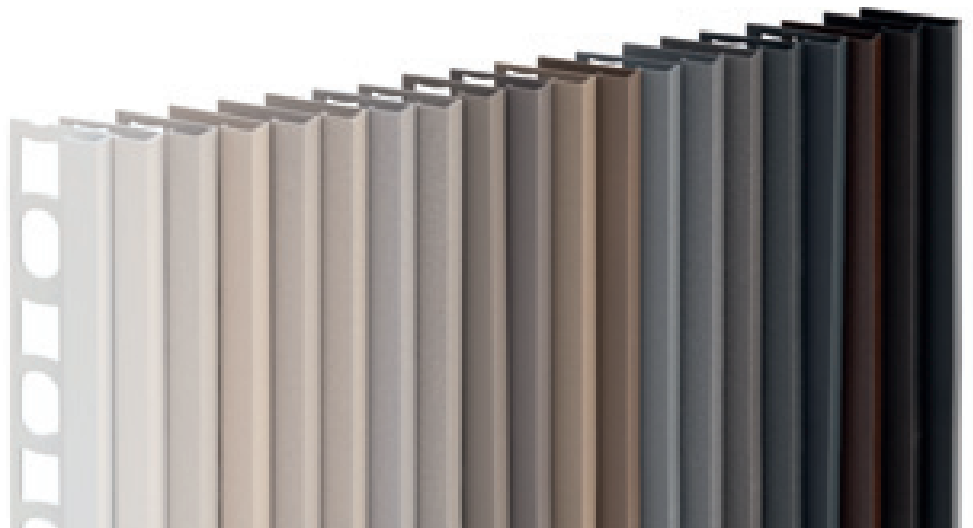

For a single piece, see sales conditions on page 288 ZQVN/10 Trend Color finishes

# external corners profiles

## cerfix® proangle Q

In anodised aluminium, X Design is characterized by a special scratched finish and original colours that allow different chromatic combinations, created for interior designers and architects by following the latest trends of modern design.

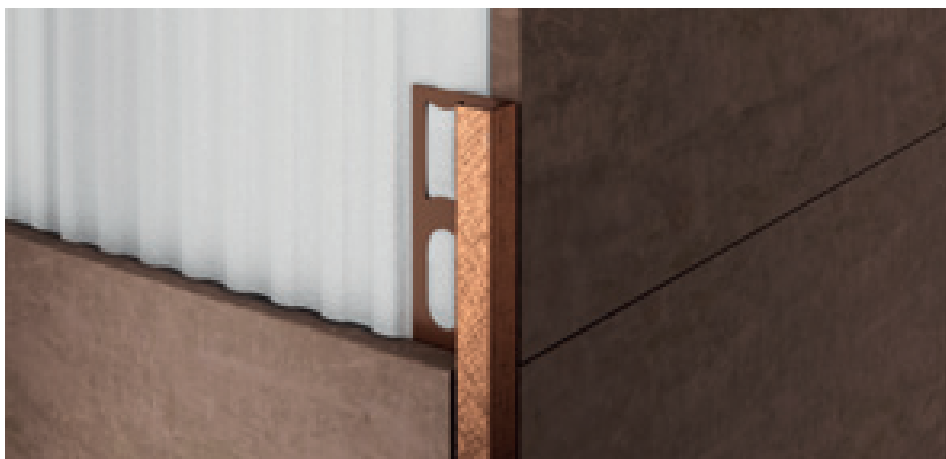





ZQAND/10 brown anodised aluminium



### PROANGLE Q - X DESIGN





length = 270 cm - pack 20 pcs

		H			
ART.	finishing	8	10	12,5	
<b>ANODISED ALUMINIUM</b>					
	platinum		31110	31112	31114
	titanium		31120	31122	31124
ZQAND/	brown		31130	31132	31134
	dark brown		31140	31142	31144
	carbon		31150	31152	31154
	<b>euro/m</b>		<b>12,59</b>	<b>13,42</b>	<b>14,27</b>

individually packed

### PROANGLE Q - X DESIGN - OUTSIDE / INSIDE CORNERS / END CAPS

pack 5 pcs

		H			
ART.	finishing	8	10	12,5	
<b>ANODISED ALUMINIUM</b>					
	platinum		31160	31162	31164
	titanium		31170	31172	31174
ZQAND/ EI	brown		31180	31182	31184
	dark brown		31190	31192	31194
	carbon		31200	31202	31204
	<b>euro/pc</b>		<b>11,07</b>	<b>11,07</b>	<b>11,07</b>

no partial packaging

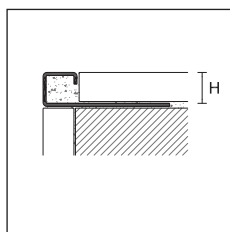

ZQAND/



Complete the article code with H measure (for example ZQAND/ for H=8 becomes ZQAND/8)

For a single piece, see sales conditions on page 288

Proangle Q in stainless steel is a line of universal profiles with square shape, specially designed to edge and protect the external corners of ceramic coverings.

They are also particularly suitable for the edging and the protection of floors and steps in different materials, such as ceramic, stone, wood and resins, and can be also used for finishing worktops and platforms.

Stainless steel makes the profile particularly resistant to chemical and atmospheric agents. The AISI 316 DIN 1.4404 quality offers superior resistance to corrosion and is therefore recommended for applications in areas subject to greater chemical stress, such as swimming pools and food industries, and coastal areas.



ZQINP/10 sandblasted stainless steel AISI 304-DIN 1.4301

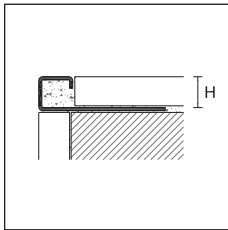

**PROANGLE Q**

length = 270 cm - pack 20 pcs

ART.	finishing		6	8	9	10	11	12,5	15
<b>STAINLESS STEEL</b>									
ZQIN/	stainless steel AISI 304 - DIN 1.4301		90049	90050	90051	90052	90053	90054	90055
	euro/m		8,63	8,94	9,23	9,49	9,79	10,08	10,87
ZQINS/	satin stainless steel AISI 304 - DIN 1.4301		90100	90101	90102	90103	90104	90105	90106
ZQINP/	sandblasted stainless steel AISI 304 - DIN 1.4301		90130	90131	90132	90133	90134	90135	90136
	euro/m		11,51	11,81	12,10	12,38	12,68	12,96	13,72
ZQINX/	stainless steel AISI 316 - DIN 1.4404		-	90107	-	90109	-	90111	-
	euro/m		-	12,34	-	13,52	-	14,71	-

individually packed - ZQIN/15, ZQINS/15 and ZQINP/15 packaging of 10 pcs

**PROANGLE Q - OUTSIDE / INSIDE CORNERS / END CAPS**

pack 5 pcs

ART.	finishing		6	8	9	10	11	12,5	15
<b>STAINLESS STEEL</b>									
ZQIN/ /EI	stainless steel AISI 304 - DIN 1.4301		90064	90065	90066	90067	90068	90069	90070
	euro/pc		12,83	12,83	12,83	12,83	12,83	12,83	12,83
ZQINS/ /EI	satin stainless steel AISI 304 - DIN 1.4301		90112	90113	90114	90115	90116	90117	90118
ZQINP/ /EI	sandblasted stainless steel AISI 304 - DIN 1.4301		90137	90138	90139	90140	90141	90142	90143
	euro/pc		14,40	14,40	14,40	14,40	14,40	14,40	14,40
ZQINX/ /EI	stainless steel AISI 316 - DIN 1.4404		-	90119	-	90121	-	90123	-
	euro/pc		-	15,79	-	15,79	-	15,79	-
<b>METAL</b>									
ZQIM/ /EI	polished stainless steel		-	90092	90093	90094	90095	90096	-
	euro/pc		-	3,56	3,56	3,56	3,56	3,56	-
ZQIMS/ /EI	satin steel		-	90152	90153	90154	90155	90156	-
	euro/pc		-	5,59	5,59	5,59	5,59	5,59	-
ZQIMP/ /EI	sandblasted steel		-	90162	90163	90164	90165	90166	-
	euro/pc		-	5,59	5,59	5,59	5,59	5,59	-

no partial packaging for ZQIM/ /EI, ZQIMS/ /EI and ZQIMP/ /EI



ZQIN/10/EI stainless steel AISI 304 - DIN 1.4301

Complete the article code with H measure (for example ZQIN/ for H=8 becomes ZQIN/8)  
For a single piece, see sales conditions on page 288

# cerfix® proangle Q

Proangle Q in polished brass is classic and modern at the same time and can be easily combined to handles, taps and other furniture accessories of the same material and finish.

The chromium-plated version stands out for its brilliance and is perfect as decorative element in spaces characterized by elegance and attention to details.



ZQKN/10 chromium-plated brass

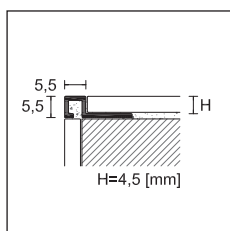

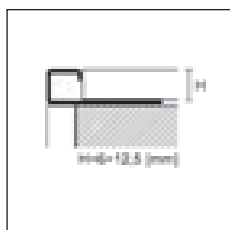

PPDESIGN



ZQKN/ EI chromium-plated brass

## PROANGLE Q



length = 270 cm - pack 20 pcs

		H					
ART.	finishing	4,5	8	10	11	12,5	
<b>POLISHED BRASS</b>							
ZQLN/	polished		90022	90056	90057	90063	90058
	euro/m		10,56	15,62	16,35	16,81	17,23
<b>CHROMIUM-PLATED BRASS</b>							
ZQKN/	chromium plated		88870	90059	90060	90074	90061
	euro/m		16,33	22,63	23,40	23,84	24,32

individually packed - ZQKN/12,5 packaging of 10 pcs

## PROANGLE Q - OUTSIDE / INSIDE CORNERS / END CAPS

length = 270 cm - pack 5 pcs

		H					
ART.	finishing	4,5	8	10	11	12,5	
<b>BRASS</b>							
ZQLN/ EI	polished		90062	90071	90072	90075	90073
	euro/pc		12,83	12,83	12,83	12,83	12,83
ZQKN/ EI	chromium plated		88872	90077	90083	90085	90087
	euro/pc		14,94	14,94	14,94	14,94	14,94

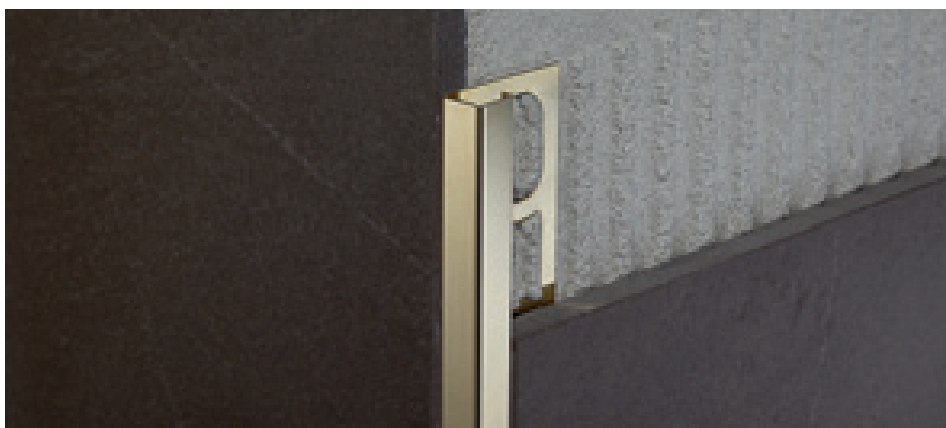

ZQLN/10 brass polished

Complete the article code with H measure (for example ZQLN/ for H=8 becomes ZQLN/8)

For a single piece, see sales conditions on page 288



Proangle Q in coextruded PVC is a line of universal profiles with square shape, specially designed to edge and protect the external corners of ceramic coverings. Thanks to the special section with soft PVC inserts, these profiles absorb the micro-movements that discharge on the corner due to the tension of the wall coverings.



ZQP/8 PVC white

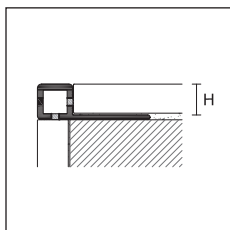









ZQP/



ZQP/8 PVC beige bahama

**PROANGLE Q**

length = 270 cm

		H				
ART.	finishing	6	8	10	12,5	
<b>CO-EXTRUDED PVC</b>						
	white		80800	80801	80802	80803
	cream white RAL 9001		80804	80805	80806	80807
	ivory RAL 1015		80808	80809	80810	80811
	beige grey RAL 1019		80812	80813	80814	80815
ZQP/	stone grey RAL 7030		80816	80817	80818	80819
	light grey RAL 7035		80820	80821	80822	80823
	anthracite		80824	80825	80826	80827
	beige bahama		80832	80833	80834	80835
	brown		80836	80837	80838	80839

pack 20 pcs

euro/m

1,24

1,34

1,45

1,55

pack 80 pcs

euro/m

-

-

-

1,37

pack 100 pcs

euro/m

1,01

1,11

1,22









-

no partial packaging

to order the pack of 80 and 100 pcs, mark /80 or /100 after the article code (for example, code 80800 becomes 80800/100)

**PROANGLE Q - OUTSIDE / INSIDE CORNERS / END CAPS**

pack 12 pcs\*

		H				
ART.	finishing	6	8	10	12,5	
<b>POLYPROPYLENE</b>						
	white		80850	80851	80852	80853
	cream white RAL 9001		80854	80855	80856	80857
	ivory RAL 1015		80858	80859	80860	80861
	beige grey RAL 1019		80862	80863	80864	80865
ZQP/	stone grey RAL 7030		80866	80867	80868	80869
/EI	light grey RAL 7035		80870	80871	80872	80873
	anthracite		80874	80875	80876	80877
	beige bahama		80882	80883	80884	80885
	brown		80886	80887	80888	80889
	euro/pc		0,97	0,97	0,97	0,97

no partial packaging - pack of 50 pcs Euro 0,74

to order the pack of 50 pcs, mark /50 after the article code (for example, code 80850 becomes 80850/50)

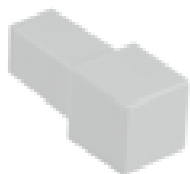

ZQP//EI  
white polypropylene

Complete the article code with H measure (for example ZQP/ for H=8 becomes ZQP/8)

\* available upon request pack of 1 pc in blister + 1,47 Euro (for example ZQP/8/EI code 80851 white becomes code 80851/B)

Colours available on demand - minimum quantity 2700 meters

For a single piece, see sales conditions on page 288

## cerfix® proangle

Proangle in aluminium is a line of profiles for edging and protecting the external corners of ceramic coverings. Its L shape outlines clearly tile coverings, such as rectified porcelain stoneware.

Available in different colours and finishes, Proangle can also be used as decorative element, creating refined and pleasant combination/contrast effects with a wide variety of coverings.

ZQVNH/ boasts the certified antibacterial technology (according to the internationally recognized laboratory test JIS Z 2801:2000) which reduces the presence of the most dangerous bacteria up to 99%, thus assuring the best hygiene over time.



ZA/10 silver anodised aluminium

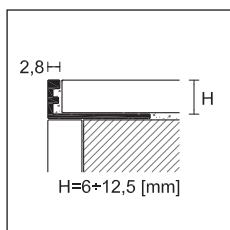
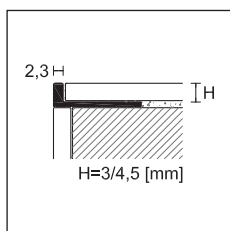

### PROANGLE

length = 270 cm - pack 20 pcs

		H								
ART.	finishing	3	4,5	6	8	9	10	11	12,5	
<b>ALUMINIUM</b>										
ZA/	silver anodised		90338	90340	88204	88205	88217	88206	88218	88207
	<i>euro/m</i>		2,95	3,08	3,15	3,23	3,31	3,39	3,66	3,91
ZA/	titanium anodised		-	-	88253	88254	-	88255	88257	88256
	<i>euro/m</i>		-	-	3,78	3,86	-	4,02	4,29	4,54
ZA/	black anodised		-	-	-	88265	-	88266	88267	88268
	<i>euro/m</i>		-	-	-	4,62	-	4,80	4,94	5,19
ZB/	bright polished silver		-	88260	88294	88295	-	88296	88220	88297
	<i>euro/m</i>		-	6,86	7,08	7,37	-	7,53	7,73	7,92
ZB/	bright polished gold		-	88261	88339	88340	-	88341	-	88342
	bright polished titanium		-	90341	88344	88345	-	88346	88348	88347
<i>euro/m</i>		-	7,06	7,30	7,59	-	7,75	7,96	8,16	
ZBS/	bright satin silver		-	-	-	-	-	88356	88357	88358
ZTM/	bright satin titanium		-	-	-	-	-	88359	88360	88361
	<i>euro/m</i>		-	-	-	-	-	8,37	8,58	8,78
ZBS/	bright satin black		-	-	-	-	-	88353	88354	88355
<i>euro/m</i>		-	-	-	-	-	-	8,75	8,96	9,18
<b>COLOUR-COATED ALUMINIUM</b>										
ZV/	colour-coated matt white RAL 9003		-	-	-	88395	-	88396	88435	88397
	colour-coated white RAL 9003		-	-	88384	88385	-	88386	88436	88387
<i>euro/m</i>		-	-	4,03	4,17	-	4,54	4,67	4,82	
<b>ANTIBACTERIAL COLOUR-COATED ALUMINIUM</b>										
ZVH/	colour-coated white RAL 9003		-	-	-	88390	-	88392	-	88394
<i>euro/m</i>		-	-	-	5,81	-	6,20	-	6,49	

individually packed

Complete the article code with H measure (for example ZA/ for H=8 becomes ZA/8)

Items ZV/ available in different colours on demand - minimum quantity 540 meters for colour.

**Proangle: for different heights till 25 mm please see page 96-97**

Items ZA-AI bendable version see page 98

For a single piece, see sales conditions on page 288



ZA/10 black anodised aluminium



ZA/10 titanium anodised aluminium

Colour-coated aluminium Trend Color Stone: modern finishes with neutral but warm and soft shades which reproduce the heterogeneity of stone thanks to a rough texture.

Colour-coated aluminium Trend Color Concrete: six original cement-effect finishes that recall the typical metropolis colours by revisiting them from a more refined point of view.

Colour-coated aluminium Trend Color Metal: two special metal tonalities which reproduce the iridescent nature of metals.



ZV/10 colour-coated aluminium beige

**NEW PROANGLE - TREND COLOR**

length = 270 cm - pack 20 pcs

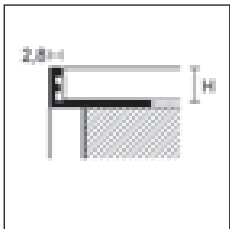

ZV/

TREND COLOR

		H		
ART.	finishing	8	10	11
<b>COLOUR-COATED ALUMINIUM</b>				
<b>TREND COLOR STONE</b>				
	dark brown	88446	88407	88417
	anthracite grey	88447	88398	88408
	ancient grey	88448	88400	88410
	grey	88449	88405	88415
	rust	88450	88399	88409
	bronze	88451	88406	88416
	stone	88452	88404	88414
	greige	88453	88403	88413
	sand	88454	88402	88412
	beige	88455	88401	88411
	white stone	88456	88428	88433
ZV/	black stone	88457	88429	88434
<b>TREND COLOR CONCRETE</b>				
	concrete white	-	88437	88461
	concrete graphite	-	88438	88462
	concrete smoke	-	88439	88463
	concrete mud	-	88440	88464
	concrete sand	-	88441	88465
	solid white	-	88460	88468
<b>TREND COLOR METAL</b>				
	metal dark	-	88458	88466
	metal light	-	88459	88467
	<b>euro/m</b>	<b>5,89</b>	<b>6,03</b>	<b>6,18</b>

individually packed - Other heights with TREND COLOR finishes are available upon request, with a minimum of 540 meters.



ZV/10 colour-coated aluminium white stone

LED-light profiles and skirting boards with Trend Color finishes on page 232 and 236.

Complete the article code with H measure (for example ZV/ for H=10 becomes ZV/10).

For a single piece, see sales conditions on page 288

Proangle in stainless steel is a line of profiles for edging and protecting the external corners of ceramic coverings. Its L shape outlines clearly tile coverings, such as rectified porcelain stoneware.

Stainless steel makes the profile particularly resistant to chemical and atmospheric agents. The AISI 316 DIN 1.4404 quality offers superior resistance to corrosion and is therefore recommended for applications in areas subject to greater chemical stress, such as swimming pools and food industries, and coastal areas.



AI/10 stainless steel AISI 304 - DIN 1.4301

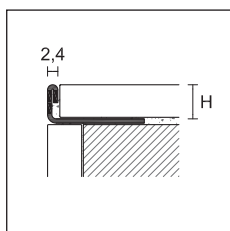

### PROANGLE

length = 270 cm - pack 20 pcs

		H								
ART.	finishing	3	4,5	6	8	9	10	11	12,5	
<b>STAINLESS STEEL</b>										
AI/	stainless steel AISI 304 - DIN 1.4301	91636	91638	91642	91644	91645	91646	91647	91648	
	euro/m	6,98	7,11	7,44	7,69	7,89	8,05	8,23	8,37	
AIL/	superpolished stainless steel AISI 304 - DIN 1.4301	-	91690	-	91694	-	91696	-	91698	
	euro/m	-	9,12	-	10,10	-	10,45	-	10,84	
AIS/	satin stainless steel AISI 304 - DIN 1.4301	-	91671	91673	91674	-	91675	91677	91676	
	euro/m	-	8,89	9,23	9,48	-	9,83	9,99	10,16	
AIP/	sandblasted stainless steel AISI 304 - DIN 1.4301	-	-	91700	91702	-	91704	91705	91706	
	euro/m	-	-	10,75	10,99	-	11,37	11,52	11,68	
AIX/	stainless steel AISI 316 - DIN 1.4404	-	-	91684	91685	-	91686	91688	91687	
	euro/m	-	-	8,76	8,96	-	9,45	9,94	10,41	

individually packed

### NEW PROANGLE - OUTSIDE CORNER

pack 5 pcs

		H								
ART.	finishing	3	4,5	6	8	9	10	11	12,5	
<b>STAINLESS STEEL</b>										
AI//E	stainless steel AISI 304 - DIN 1.4301	-	-	-	-	-	91663	91664	91665	
	euro/pc	-	-	-	-	-	7,77	7,77	7,77	
AIS//E	satin stainless steel AISI 304 - DIN 1.4301	-	-	-	-	-	91680	91681	91682	
	euro/pc	-	-	-	-	-	8,82	8,82	8,82	

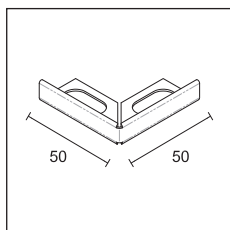

AI//E  
AIS//E



AI//E stainless steel AISI 304 - DIN 1.4301

Complete the article code with H measure  
(for example AI/ for H=10 becomes AI/10)

For a single piece, see sales conditions on page 288

cerfix® proangle-prodecor

Proangle ZK and Prodecor DJK are two L-shaped profiles in chromium-plated brass, with different section, designed for edging and protecting the external corners of ceramic coverings. Chromium-plated brass stands out for its brilliance and is perfect as decorative element in spaces characterized by elegance and attention to details.



Proangle ZK/ chromium-plated brass

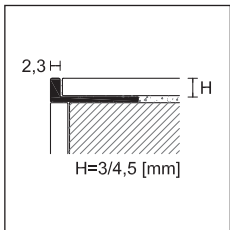

ZK/

PPDESIGN

**PROANGLE**

length = 270 cm - pack 20 pcs

ART.	finishing	4,5	6	8	9	10	11	12,5
<b>CHROMIUM-PLATED BRASS</b>								
ZK/	chromium plated	90081	88114	88115	-	88116	88118	88117
	euro/m	16,93	17,05	17,63	-	18,02	18,29	18,67

individually packed

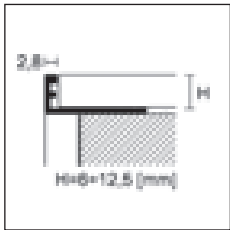

ZK/

PPDESIGN

**PRODECOR DJ**

length = 270 cm - pack 20 pcs

ART.	finishing	8	10	12,5	15	20
<b>CHROMIUM-PLATED BRASS</b>						
DJK/	chromium plated	95700	95702	95704	95703	95705
	euro/m	18,87	19,31	19,86	20,69	22,24

individually packed - art. DJK/20 pack 10 pcs

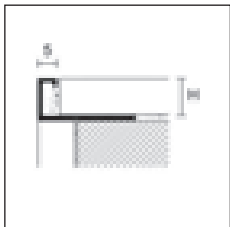

DJK/

**PRODECOR DJ - OUTSIDE AND INSIDE CORNERS**

pack 5 pcs

ART.	finishing	8	10	12,5	15	20
<b>CHROMIUM-PLATED BRASS</b>						
DJK/ /EI	chromium plated	95706	95707	95708	95709	95710
	euro/pc	16,15	16,15	16,15	16,15	16,15

no partial packaging



DJK/ /EI



Prodecor DJK/ chromium-plated brass

Complete the article code with H measure (for example ZK/ for H=8 becomes ZK/8)

For a single piece, see sales conditions on page 288

# external corners profiles

## cerfix® proangle

Proangle in PVC is a line of profiles for edging and protecting the external corners of ceramic coverings. Its L shape outlines clearly tile coverings, such as rectified porcelain stoneware. Available in many different colours, they can be used in the most varied spaces.



PV/8 PVC beige grey

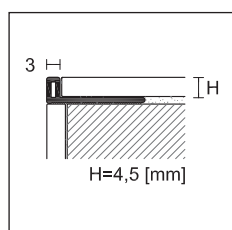



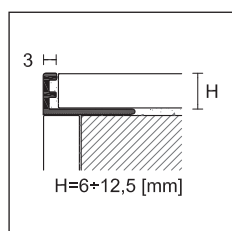









PV/



PV/

### PROANGLE

length = 270 cm

		H					
ART.	finishing	4,5	6	8	10	12,5	
<b>PVC</b>							
	snow white		80610	80496	80497	80498	80499
	white		80611	80500	80501	80502	80503
	cream white RAL 9001		-	80504	80505	80506	80507
	ivory RAL 1015		-	80508	80509	80510	-
	beige grey RAL 1019		-	80512	80513	80514	-
<b>PV/</b>	beige bahama		-	80552	80553	80554	-
	stone grey RAL 7030		-	80516	80517	80518	-
	ash grey RAL 7038		-	80520	80521	80522	-
	light grey RAL 7035		-	80524	80525	80526	80527
	anthracite		-	80559	80560	80561	-
	red RAL 3002		-	80528	80529	80530	-
	black RAL 9005		-	80532	80533	80534	-
<b>pack 20 pcs</b>							
<b>euro/m</b>			<b>1,14</b>	<b>1,19</b>	<b>1,28</b>	<b>1,39</b>	<b>1,49</b>
<b>pack 100 pcs</b>							
<b>euro/m</b>			<b>0,91</b>	<b>0,96</b>	<b>1,05</b>	<b>1,16</b>	<b>1,26</b>

no partial packaging

to order the pack of 100 pcs, mark /100 after article code (for example code 80497 becomes 80497/100)

Complete the article code with H measure  
(for example PV/ for H=8 becomes PV/8)

Items PV/ available in different colours on demand - minimum quantity 2700 meters for colour

For a single piece, see sales conditions on page 288

Protrim IP are minimalist profiles in aluminium or stainless steel, suitable for the edging of external corners that need the 45 degrees cut. These profiles allow a perfect installation both on wall coverings and on stairs or platforms in ceramic or wood.



IPA/11 silver anodised aluminium



IPI/11 stainless steel AISI 304 - DIN 1.4301

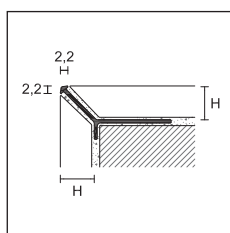

IPA/  
IPB/  
IPV/

**PROTRIM IP**

length = 270 cm - pack 20 pcs

		H			
ART.	finishing	4,5	8	11	15
<b>ALUMINIUM</b>					
IPA/	silver anodised	95006	95178	95181	95185
	euro/m	4,17	4,28	4,28	4,50
IPB/	bright polished silver	95008	-	-	-
	euro/m	7,02			

individually packed

**TREND COLOR**

**PROTRIM IP - TREND COLOR STONE**

length = 270 cm - pack 20 pcs

		H	
ART.	finishing	11	
<b>COLOUR-COATED ALUMINIUM</b>			
<b>TREND COLOR STONE</b>			
	dark brown	95182	
	anthracite grey	95183	
	ancient grey	95184	
	grey	95186	
IPV/	rust	95187	
	bronze	95188	
	stone	95189	
	greige	95190	
	sand	95191	
	beige	95192	
	white stone	95193	
	black stone	95194	
	euro/m	7,28	

individually packed - Other heights with TREND COLOR finishes are available upon request, with a minimum of 540 meters.

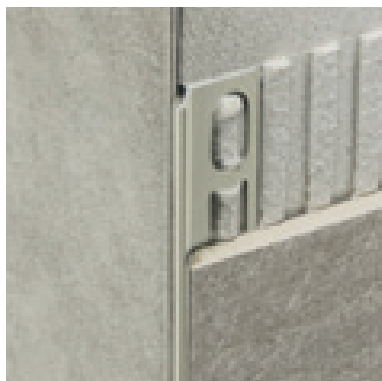

IPV/11 beige colour-coated aluminium

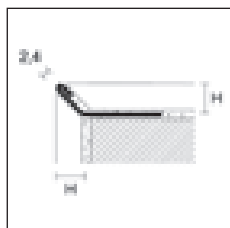

IPI/

**PROTRIM IP**

length = 270 cm - pack 20 pcs

		H			
ART.	finishing	7	8	11	12,5
<b>STAINLESS STEEL</b>					
IPI/	stainless steel AISI 304 - DIN 1.4301	95169	95170	95173	95174
	euro/m	8,45	8,73	9,24	9,63

individually packed

Complete the article code with H measure (es: IPA/ for H=10 becomes IPA/10)

For a single piece, see sales conditions on page 288

Protrim in aluminium is a line of profiles with rounded shape, specially designed to edge and protect the external corners of ceramic coverings. Their shape also acts as symmetric finishing and helps preventing accidents.

RVH/ boasts the certified antibacterial technology (according to the internationally recognized laboratory test JIS Z 2801:2000) which reduces the presence of the most dangerous bacteria up to 99%, thus assuring the best hygiene over time.



RA/10 silver anodised aluminium

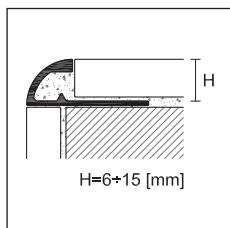
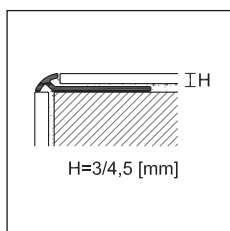

### PROTRIM

length = 270 cm - pack 20 pcs

		H								
ART.	finishing	3	4,5	6	8	10	11	12,5	15	
<b>ALUMINIUM</b>										
RA/	silver anodised	92055	92056	92070	92072	92074	92060	92076	92078	
	gold anodised	92025	92026	92040	92042	92044	-	92046	-	
	<b>euro/m</b>	<b>3,77</b>	<b>3,98</b>	<b>4,34</b>	<b>4,53</b>	<b>4,89</b>	<b>5,26</b>	<b>5,57</b>	<b>6,21</b>	
RB/	titanium anodised	92085	92086	92087	92090	92094	-	92096	-	
	<b>euro/m</b>	<b>4,40</b>	<b>4,61</b>	<b>4,97</b>	<b>5,16</b>	<b>5,52</b>	-	<b>6,20</b>	-	
RB/	bright polished silver	92315	92316	92310	92312	92314	92061	92318	-	
	<b>euro/m</b>	<b>6,46</b>	<b>6,68</b>	<b>6,96</b>	<b>7,54</b>	<b>8,33</b>	<b>8,83</b>	<b>9,38</b>	-	
RT/	bright polished gold	92325	92326	92340	92342	92344	-	92348	-	
	bright polished titanium	92015	92016	92018	92020	92022	-	92023	-	
<b>euro/m</b>	<b>6,68</b>	<b>6,88</b>	<b>7,18</b>	<b>7,76</b>	<b>8,58</b>	-	<b>9,67</b>	-		
RAS/	bright satin silver	92050	92051	92071	92073	92075	92062	92077	-	
	bright satin gold	-	-	92041	92043	92045	-	92047	-	
RTM/	bright satin titanium	92053	92057	92064	92066	92068	-	92079	-	
	<b>euro/m</b>	<b>7,97</b>	<b>8,17</b>	<b>8,56</b>	<b>8,78</b>	<b>9,57</b>	<b>10,07</b>	<b>10,66</b>	-	
<b>COLOUR-COATED ALUMINIUM</b>										
RV/	matt white RAL 9003	-	-	-	92107	92108	92109	92110	-	
	white RAL 9003	-	-	92100	92102	92104	92111	92106	-	
<b>euro/m</b>	-	-	<b>4,83</b>	<b>5,38</b>	<b>5,81</b>	<b>6,04</b>	<b>6,25</b>	-		
<b>ANTIBACTERIAL COLOUR-COATED ALUMINIUM</b>										
RVH/	white RAL 9003	-	-	-	92112	92114	-	92116	-	
<b>euro/m</b>	-	-	-	<b>7,11</b>	<b>7,57</b>	-	<b>8,03</b>	-		

individually packed

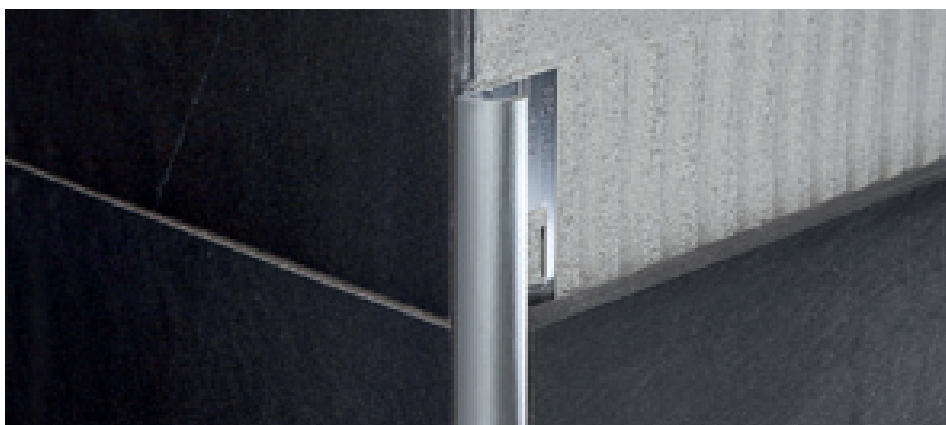

RAS/10 bright satin silver aluminium

Complete the article code with H measure (for example RA/ for H=8 becomes RA/8)

Items RV/ available in different colours on demand - minimum quantity 540 meters for colour

For a single piece, see sales conditions on page 288





## PROTRIM - OUTSIDE CORNER

pack 5 pcs*		H					
ART.	finishing	6	8	10	11	12,5	
<b>ALUMINIUM</b>							
TA/	silver anodised		92606	92608	92610	92600	92612
	gold anodised		92614	92616	92618	-	92619
	titanium anodised		92564	92566	92568	-	92569
	<i>euro/pc</i>		<b>4,20</b>	<b>4,20</b>	<b>4,20</b>	<b>4,20</b>	<b>4,20</b>
TB/	bright polished silver		92690	92692	92694	92601	92696
	bright polished gold		92700	92702	92704	-	92706
TAT/	bright polished titanium		92724	92726	92728	-	92729
	<i>euro/pc</i>		<b>4,20</b>	<b>4,20</b>	<b>4,20</b>	<b>4,20</b>	<b>4,20</b>
TAS/	bright satin silver		92710	92711	92712	92602	92713
	bright satin gold		92720	92721	92722	-	92723
TATM/	bright satin titanium		92714	92716	92718	-	92773
	<i>euro/pc</i>		<b>6,72</b>	<b>6,72</b>	<b>6,72</b>	<b>6,72</b>	<b>6,72</b>
<b>COLOUR-COATED ALUMINIUM</b>							
TV/	matt white RAL 9003		-	92636	92637	92638	92639
	white RAL 9003		92620	92622	92624	92628	92626
	<i>euro/pc</i>		<b>4,20</b>	<b>4,20</b>	<b>4,20</b>	<b>4,20</b>	<b>4,20</b>

no partial packaging

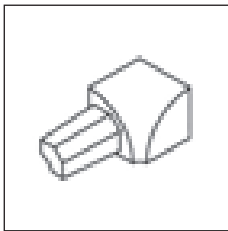

## PROTRIM - INSIDE CORNER

pack 5 pcs*		H					
ART.	finishing	6	8	10	11	12,5	
<b>ALUMINIUM</b>							
TIA/	silver anodised		92570	92571	92572	92603	92573
	gold anodised		92575	92576	92577	-	92578
	titanium anodised		92554	92555	92556	-	92558
	<i>euro/pc</i>		<b>4,20</b>	<b>4,20</b>	<b>4,20</b>	<b>4,20</b>	<b>4,20</b>
TIB/	bright polished silver		92580	92581	92582	92604	92583
	bright polished gold		92585	92586	92587	-	92588
TIAT/	bright polished titanium		92730	92732	92734	-	92736
	<i>euro/pc</i>		<b>4,20</b>	<b>4,20</b>	<b>4,20</b>	<b>4,20</b>	<b>4,20</b>
TIAS/	bright satin silver		92550	92551	92552	92605	92553
	bright satin gold		92560	92561	92562	-	92563
	<i>euro/pc</i>		<b>6,72</b>	<b>6,72</b>	<b>6,72</b>	<b>6,72</b>	<b>6,72</b>
<b>COLOUR-COATED ALUMINIUM</b>							
TIV/	matt white RAL 9003		-	92646	92647	92648	92649
	white RAL 9003		92621	92623	92625	92629	92627
	<i>euro/pc</i>		<b>4,20</b>	<b>4,20</b>	<b>4,20</b>	<b>4,20</b>	<b>4,20</b>

no partial packaging

Complete the article code with H measure  
(for example TA/ for H=8 becomes TA/8)

\* available upon request pack of 1 pc in blister  
+ 1,47 Euro (for example TA/6 code 92606  
becomes 92606/B)

For a single piece, see sales conditions on page 288

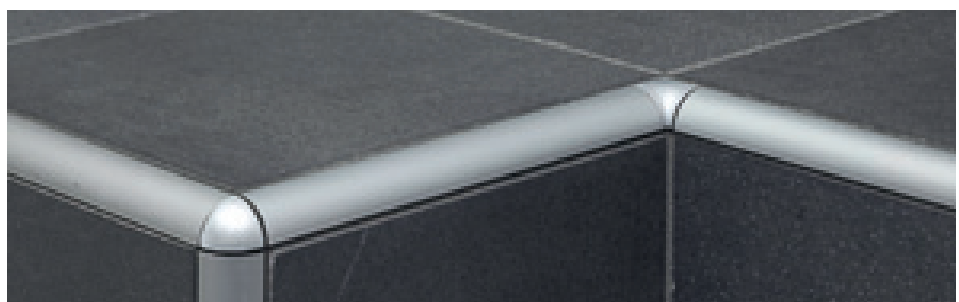

RA/10+TA/10+TIA/10 silver anodised aluminium

## cerfix® protrim

Protrim in stainless steel is a line of profiles with rounded shape, specially designed to edge and protect the external corners of ceramic coverings and also recommended for floors, steps, worktops and platforms.

The AISI 304 versions are recommended for food industries, kitchens, hospitals and outdoor spaces, while the AISI 316 versions are suggested in case of difficult applications, such as swimming pools, spas and places exposed to salt.



RI/10 stainless steel AISI 304 DIN 1.4301

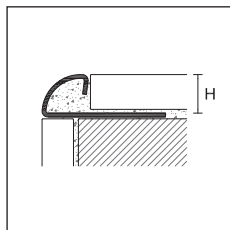

### PROTRIM

length = 270 cm - pack 20 pcs

ART.	finishing	H								
		4,5	6	8	9	10	11	12,5	15	
<b>STAINLESS STEEL</b>										
<b>RI/</b>	stainless steel AISI 304 DIN 1.4301	92413	92420	92422	92423	92424	92425	92426	92428	
	<i>euro/m</i>	<b>8,27</b>	<b>9,01</b>	<b>9,63</b>	<b>10,10</b>	<b>10,40</b>	<b>10,67</b>	<b>11,05</b>	<b>12,41</b>	
<b>RIL/</b>	superpolished stainless steel AISI 304 - DIN 1.4301	92415	92416	92417	-	92418	-	92419	-	
	<i>euro/m</i>	<b>10,27</b>	<b>11,48</b>	<b>12,11</b>	-	<b>12,87</b>	-	<b>13,55</b>	-	
<b>RIS/</b>	satin stainless steel AISI 304 - DIN 1.4301	-	92430	92431	92438	92432	92439	92433	92434	
	<i>euro/m</i>	-	<b>10,79</b>	<b>11,40</b>	<b>11,88</b>	<b>12,17</b>	<b>12,46</b>	<b>12,83</b>	<b>14,20</b>	
<b>RIP/</b>	sandblasted stainless steel AISI 304 - DIN 1.4301	-	92450	92451	92452	92453	92454	92455	-	
	<i>euro/m</i>	-	<b>11,01</b>	<b>11,63</b>	<b>12,13</b>	<b>12,41</b>	<b>12,73</b>	<b>13,08</b>	-	
<b>RIX/</b>	stainless steel AISI 316 - DIN 1.4404	92405	92406	92407	92410	92408	92411	92409	-	
	<i>euro/m</i>	<b>10,70</b>	<b>11,51</b>	<b>12,38</b>	<b>12,87</b>	<b>13,26</b>	<b>13,62</b>	<b>14,15</b>	-	

individually packed - art. RI/15 pack 10 pcs

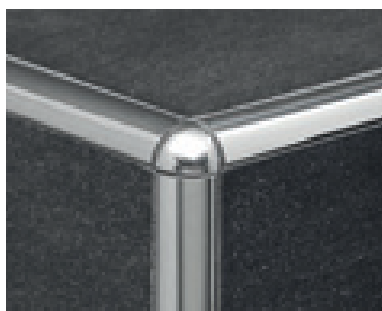

RIL/10 + TIEL/10 superpolished stainless steel

### PROTRIM - OUTSIDE CORNER - pack 5 pcs

<b>TIE/</b>	stainless steel AISI 304 - DIN 1.4301	92750	92480	92481	92751	92482	92752	92483	92484	
	<i>euro/pc</i>	<b>11,16</b>	<b>11,87</b>	<b>12,42</b>	<b>12,62</b>	<b>13,00</b>	<b>13,73</b>	<b>14,11</b>	<b>15,24</b>	
<b>TIEL/</b>	superpolished stainless steel AISI 304 - DIN 1.4301	92790	92792	92794	-	92798	-	92802	-	
	<i>euro/pc</i>	<b>12,05</b>	<b>12,81</b>	<b>13,38</b>	-	<b>14,04</b>	-	<b>15,05</b>	-	
<b>TIES/</b>	satin stainless steel AISI 304 - DIN 1.4301	-	92485	92486	92753	92487	92754	92488	92489	
	<i>euro/pc</i>	-	<b>12,81</b>	<b>13,38</b>	<b>13,65</b>	<b>14,04</b>	<b>14,69</b>	<b>15,05</b>	<b>16,35</b>	
<b>TIEP/</b>	sandblasted stainless steel AISI 304 - DIN 1.4301	-	92510	92511	92512	92513	92514	92515	-	
	<i>euro/pc</i>	-	<b>12,81</b>	<b>13,38</b>	<b>13,65</b>	<b>14,04</b>	<b>14,69</b>	<b>15,05</b>	-	
<b>TIEX/</b>	stainless steel AISI 316 - DIN 1.4404	92500	92501	92502	92755	92503	92756	92504	-	
	<i>euro/pc</i>	<b>12,97</b>	<b>13,73</b>	<b>14,30</b>	<b>14,50</b>	<b>14,88</b>	<b>15,61</b>	<b>16,00</b>	-	

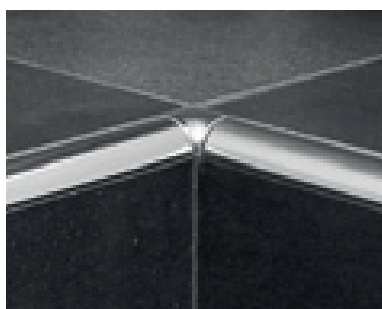

RIL/10 + TIIL/10 superpolished stainless steel

### PROTRIM - INSIDE CORNER - pack 5 pcs

<b>TII/</b>	stainless steel AISI 304 - DIN 1.4301	92759	92490	92491	92757	92492	92758	92493	92494	
	<i>euro/pc</i>	<b>11,66</b>	<b>12,42</b>	<b>13,00</b>	<b>13,73</b>	<b>14,11</b>	<b>14,88</b>	<b>15,24</b>	<b>16,38</b>	
<b>TIIL/</b>	stainless steel superpolished AISI 304 - DIN 1.4301	92791	92793	92795	-	92799	-	92803	-	
	<i>euro/pc</i>	<b>12,52</b>	<b>13,38</b>	<b>13,94</b>	-	<b>15,05</b>	-	<b>16,18</b>	-	
<b>TIIS/</b>	satin stainless steel AISI 304 - DIN 1.4301	-	92495	92496	92760	92497	92761	92498	92499	
	<i>euro/pc</i>	-	<b>13,38</b>	<b>13,94</b>	<b>14,69</b>	<b>15,05</b>	<b>15,72</b>	<b>16,18</b>	<b>17,48</b>	
<b>TIIP/</b>	sandblasted stainless steel AISI 304 - DIN 1.4301	-	92516	92517	92518	92519	92520	92521	-	
	<i>euro/pc</i>	-	<b>13,38</b>	<b>13,94</b>	<b>14,69</b>	<b>15,05</b>	<b>15,72</b>	<b>16,18</b>	-	
<b>TIIX/</b>	stainless steel AISI 316 - DIN 1.4404	92505	92506	92507	92762	92508	92763	92509	-	
	<i>euro/pc</i>	<b>13,53</b>	<b>14,30</b>	<b>14,88</b>	<b>15,61</b>	<b>16,00</b>	<b>16,66</b>	<b>17,12</b>	-	

Complete the article code with H measure (for example RI/ for H=8 becomes RI/8)

For a single piece, see sales conditions on page 288

**METAL**

OUTSIDE CORNER - pack 5 pcs

<b>TIME/</b>	polished stainless steel		-	-	92960	-	92964	92966	-	-
	<i>euro/pc</i>		-	-	<b>4,20</b>	-	<b>4,20</b>	<b>4,20</b>	-	-

INSIDE CORNER - pack 5 pcs

<b>TIMI/</b>	polished stainless steel		-	-	92970	-	92974	92976	-	-
	<i>euro/pc</i>		-	-	<b>4,20</b>	-	<b>4,20</b>	<b>4,20</b>	-	-

no partial packaging



RIN/10 stainless steel AISI 304 - DIN 1.4301

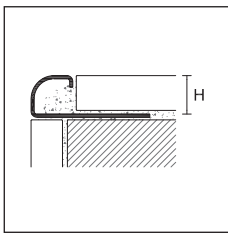

RIN/  
RINS/  
RINX/

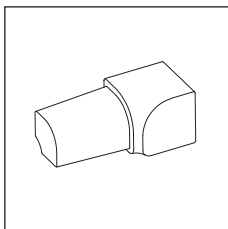

Complete the article code with H measure (for example RIN/ for H=8 becomes RIN/8)



Angles available on request pack of 1 pc in blister + 1,47 Euro (for example TIME/8 code 92960 becomes 92960/B)

For insertion and adjustment of corners TIME/ and TIMI/ we recommend the use of adhesive type PP/96

For a single piece, see sales conditions on page 288



**PROTRIM N**

length = 270 cm - pack 20 pcs



ART.	finishing		8	10	12,5
<b>STAINLESS STEEL</b>					
<b>RIN/</b>	stainless steel AISI 304 - DIN 1.4301		92353	92356	92359
	<i>euro/m</i>		<b>9,63</b>	<b>10,40</b>	<b>11,05</b>
<b>RINS/</b>	satin stainless steel AISI 304 - DIN 1.4301		92354	92357	92360
	<i>euro/m</i>		<b>11,40</b>	<b>12,17</b>	<b>12,83</b>
<b>RINX/</b>	stainless steel AISI 316 - DIN 1.4404		92355	92358	92361
	<i>euro/m</i>		<b>12,38</b>	<b>13,26</b>	<b>14,15</b>

individually packed

**PROTRIM N - OUTSIDE CORNER - pack 5 pcs**

<b>TIEN/</b>	stainless steel AISI 304 - DIN 1.4301		92813	92816	92819
	<i>euro/pc</i>		<b>12,42</b>	<b>13,00</b>	<b>14,11</b>
<b>TIENS/</b>	satin stainless steel AISI 304 - DIN 1.4301		92814	92817	92820
	<i>euro/pc</i>		<b>13,38</b>	<b>14,04</b>	<b>15,05</b>
<b>TIENX/</b>	stainless steel AISI 316 - DIN 1.4404		92815	92818	92821
	<i>euro/pc</i>		<b>14,30</b>	<b>14,88</b>	<b>16,00</b>

**PROTRIM N - INSIDE CORNER - pack 5 pcs**

<b>TIIN/</b>	stainless steel AISI 304 - DIN 1.4301		92828	92831	92834
	<i>euro/pc</i>		<b>13,00</b>	<b>14,11</b>	<b>15,24</b>
<b>TIINS/</b>	satin stainless steel AISI 304 - DIN 1.4301		92829	92832	92835
	<i>euro/pc</i>		<b>13,94</b>	<b>15,05</b>	<b>16,18</b>
<b>TIINX/</b>	stainless steel AISI 316 - DIN 1.4404		92830	92833	92836
	<i>euro/pc</i>		<b>14,88</b>	<b>16,00</b>	<b>17,12</b>

## cerfix® protrim

Protrim in polished brass is classic and modern at the same time and can be easily combined to handles, taps and other furniture accessories of the same material and finish.

The chromium-plated version stands out for its brilliance and is perfect as decorative element in spaces characterized by elegance and attention to details.



RKN/10 chromium-plated brass

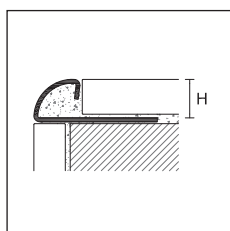



RLN/  
RKN/

PPDESIGN

### PROTRIM

length = 270 cm - pack 20 pcs

		H				
ART.	finishing	6	8	10	12,5	
<b>POLISHED BRASS</b>						
RLN/	polished		92465	92466	92467	92468
	euro/m		17,96	18,50	19,81	20,74
<b>CHROMIUM-PLATED BRASS</b>						
RKN/	chromium plated		92469	92470	92471	92472
	euro/m		23,00	23,77	25,10	26,04



individually packed - art. RLN/10, RLN/12,5, RKN/10, RKN/12,5 packaging of 10 pcs



TB/  
TIEL/

### PROTRIM - OUTSIDE / INSIDE CORNERS

pack 5 pcs

		H				
ART.	finishing	6	8	10	12,5	
<b>OUTSIDE CORNERS FOR RLN/ ARTICLES</b>						
<b>ALUMINIUM</b>						
TB/	bright polished gold		92700	92702	92704	92706
	euro/pc		4,20	4,20	4,20	4,20
<b>INSIDE CORNERS FOR RLN/ ARTICLES</b>						
<b>ALUMINIUM</b>						
TIB/	bright polished gold		92585	92586	92587	92588
	euro/pc		4,20	4,20	4,20	4,20

no partial packaging

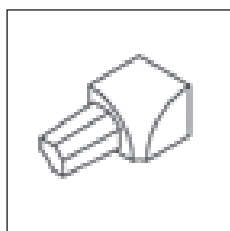

TIB/  
TIIL/

pack 5 pcs

OUTSIDE CORNERS IN SUPERPOLISHED STAINLESS STEEL FOR RKN/ ITEMS

### STAINLESS STEEL

TIEL/	superpolished stainless steel AISI 304 DIN 1.4301		92792	92794	92798	92802
	euro/pc		12,81	13,38	14,04	15,05

INSIDE CORNERS IN SUPERPOLISHED STAINLESS STEEL FOR RKN/ ITEMS

### STAINLESS STEEL

TIIL/	superpolished stainless steel AISI 304 DIN 1.4301		92793	92795	92799	92803
	euro/pc		13,38	13,94	15,05	16,18

Complete the article code with H measure  
(for example RLN/ for H=8 becomes RLN/8)

For a single piece, see sales conditions on page 288

Protrim in coextruded PVC is a line of profiles with rounded shape, specially designed to edge and protect the external corners of ceramic coverings. Their shape also acts as symmetric finishing and helps preventing accidents. Thanks to the special section with soft PVC inserts, these profiles absorb the micro-movements that discharge on the corner due to the tension of the wall coverings. Mass-dye coloured, they are available in many different colours and can be used in the most varied spaces.



RPA/8 white co-extruded PVC

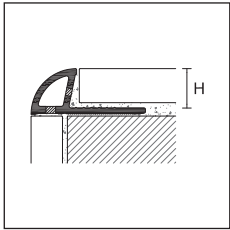

RPA/

**PROTRIM**

length = 270 cm - pack 20/100 pcs

		H		
		CO-EXTRUDED PVC		
ART.	finishing	6	8	10
	snow white	80640	80641	80642
	white	80644	80645	80646
	cream white RAL 9001	80648	80649	80650
	ivory RAL 1015	80652	80653	80654
<b>RPA/</b>	beige grey RAL 1019	80656	80657	80658
	stone grey RAL 7030	80660	80661	80662
	ash grey RAL 7038	80664	80665	80666
	light grey RAL 7035	80668	80669	80670
	beige bahama	80680	80681	80682
	brown	80692	80693	80694
<b>pack 20 pcs</b>				
<b>euro/m</b>		<b>1,24</b>	<b>1,34</b>	<b>1,45</b>
<b>pack 100 pcs</b>				
<b>euro/m</b>		<b>1,01</b>	<b>1,11</b>	<b>1,22</b>

no partial packaging

To order profiles in packs of 100 pcs, mark /100 after article code (for example code 80640 becomes 80640/100)

**PROTRIM**

pack 12 pcs\*

		H					
		TPAE/			TPAI/		
		POLYPROPYLENE					
		OUTSIDE CORNER			INSIDE CORNER		
finishing		6	8	10	6	8	10
snow white		80700	80701	80702	80753	80751	80752
white		80703	80704	80705	80750	80754	80755
cream white RAL 9001		80706	80707	80708	80756	80757	80758
ivory RAL 1015		80709	80710	80711	80759	80760	80761
beige grey RAL 1019		80712	80713	80714	80762	80763	80764
stone grey RAL 7030		80715	80716	80717	80765	80766	80767
ash grey RAL 7038		80718	80719	80720	80768	80769	80770
light grey RAL 7035		80721	80722	80723	80771	80772	80773
beige bahama		80730	80731	80732	80780	80781	80782
brown		80739	80740	80741	80789	80790	80791
<b>euro/pc</b>		<b>0,97</b>	<b>0,97</b>	<b>0,97</b>	<b>0,97</b>	<b>0,97</b>	<b>0,97</b>

To order corners in packs of 50 pcs, mark /50 after article code (for example code 80700 becomes 80700/50) - pack of 50 pcs Euro 0,74/pc

Complete the article code with H measure (for example RPA/ for H=8 becomes RPA/8)

\* available upon request pack of 1 pc in blister + 1,47 Euro (for example TPAE/8 code 80701 becomes 80701/B)

For a single piece, see sales conditions on page 288

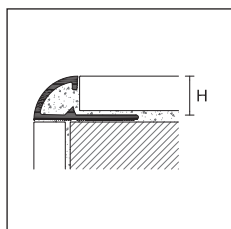

RE/



RE/8 PVC red RAL 3002

**PROTRIM**

lengt = 270 cm - pack 20/100 pcs

ART.	finishing	H			
		6	8	10	12,5
		<b>PVC</b>			
	snow white	79996	79997	79998	79999
	white	80100	80101	80102	80103
	cream white RAL 9001	80104	80105	80106	80107
	ivory RAL 1015	80108	80109	80110	-
	beige grey RAL 1019	80112	80113	80114	-
	stone grey RAL 7030	80116	80117	80118	-
	ash grey RAL 7038	80120	80121	80122	-
	light grey RAL 7035	80124	80125	80126	80127
	anthracite	80175	80176	80177	-
	blue	80160	80161	80162	-
	pastel blue	80140	80141	80142	-
	light green	80179	80180	80181	-
	red RAL 3002	80128	80129	80130	-
	black RAL 9005	80132	80133	80134	-
	yellow RAL 1023	80136	80137	80138	-
	pastel pink	80144	80145	80146	-
	beige bahama	80150	80151	80152	-
	peach	80154	80155	80156	-
	caramel	80164	80165	80166	-
	brown	80168	80169	80170	-
	dark brown	80172	80173	80174	-
	coral red	80187	80188	80189	-
	raw sienna	80191	80192	80193	-
	terracotta	80195	80362	80194	-
	<b>pack 20 pcs - euro/m</b>	<b>1,19</b>	<b>1,28</b>	<b>1,39</b>	<b>1,49</b>
	<b>pack 100 pcs - euro/m</b>	<b>0,96</b>	<b>1,05</b>	<b>1,16</b>	<b>1,26</b>

RE/

Complete the article code with H measure (for example RE/ for H=8 becomes RE/8)

For a single piece, see sales conditions on page 288

no partial packaging - to order the pack of 100 pcs, mark /100 after article code

**PROTRIM**

pack 12 pcs\*

ART.	finishing	H				H			
		6	8	10	12,5	6	8	10	12,5
		<b>TE/</b>				<b>TE/</b>			
		<b>POLYPROPYLENE</b>							
		<b>OUTSIDE CORNER</b>				<b>INSIDE CORNER</b>			
	snow white	80396	80397	80398	80399	79800	79801	79802	79803
	white	80400	80401	80402	80403	79804	79805	79806	79807
	cream white RAL 9001	80404	80405	80406	80407	79808	79809	79810	79811
	ivory RAL 1015	80408	80409	80410	-	79812	79813	79814	-
	beige grey RAL 1019	80412	80413	80414	-	79816	79817	79818	-
	stone grey RAL 7030	80416	80417	80418	-	79820	79821	79822	-
	ash grey RAL 7038	80420	80421	80422	-	79824	79825	79826	-
	light grey RAL 7035	80424	80425	80426	80427	79828	79829	79830	79831
	anthracite	80479	80480	80481	-	79875	79876	79877	-
	blue	80470	80471	80472	-	79848	79849	79850	-
	pastel blue	80440	80441	80442	-	79844	79845	79846	-
	light green	80475	80476	80477	-	79879	79880	79881	-
	red RAL 3002	80428	80429	80430	-	79832	79833	79834	-
	black RAL 9005	80432	80433	80434	-	79836	79837	79838	-
	yellow RAL 1023	80436	80437	80438	-	79840	79841	79842	-
	pastel pink	80444	80445	80446	-	79852	79853	79854	-
	beige bahama	80448	80449	80450	-	79856	79857	79858	-
	peach	80452	80453	80454	-	79860	79861	79862	-
	caramel	80458	80459	80460	-	79864	79865	79866	-
	brown	80462	80463	80464	-	79868	79869	79870	-
	dark brown	80466	80467	80468	-	79872	79873	79874	-
	coral red	80483	80484	80485	-	79887	79888	79889	-
	raw sienna	80487	80488	80489	-	79891	79892	79893	-
	terracotta	80491	80492	80493	-	79895	79896	79897	-
	<b>euro/pc</b>	<b>0,97</b>	<b>0,97</b>	<b>0,97</b>	<b>0,97</b>	<b>0,97</b>	<b>0,97</b>	<b>0,97</b>	<b>0,97</b>

no partial packaging

\* available upon request pack of 1 pc in blister + 1,47 Euro (for example TE/8 code 80397 becomes 80397/B) - To order corners in packs of 50 pcs, mark /50 after article code (for example code 80396 becomes 80396/50) pack of 50 pcs. €/pcs 0,74 - For a single piece, see sales conditions on page 288

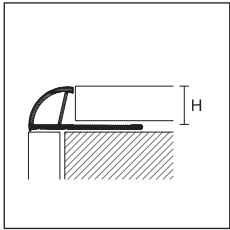

RECO/

**PROTRIM ECO**

length = 260 cm - pack 80 pcs

ART.	finishing	ECOLINE PVC			
		6	8	10	
	snow white		79400	79401	79402
	white		79403	79404	79405
	cream white RAL 9001		79406	79407	79408
<b>RECO/ /80</b>	ivory RAL 1015		79409	79410	79411
	ash grey RAL 7038		79412	79413	79414
	light grey RAL 7035		79415	79416	79417
	beige bahama		79418	79419	79420
	<b>euro/m</b>		<b>0,69</b>	<b>0,76</b>	<b>0,84</b>

no partial packaging

others colour on request for minimum 2600 mt for colour

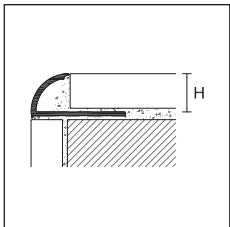

REC/

**PROTRIM ECO**

length = 260 cm - pack 100 pcs

ART.	finishing	ECOLINE PVC			
		-	8	10	
	snow white		-	79601/100	79602/100
	cream white RAL 9001		-	79605/100	79606/100
	ivory RAL 1015		-	-	79610/100
	beige grey RAL 1019		-	-	79614/100
<b>REC/ /100</b>	stone grey RAL 7030		-	-	79618/100
	ash grey RAL 7038		-	-	79622/100
	light grey RAL 7035		-	-	79626/100
	beige bahama		-	-	79642/100
	<b>euro/m</b>		-	<b>0,67</b>	<b>0,74</b>

no partial packaging

others colour on request for minimum 2600 mt for colour

Complete the article code with H measure  
(for example REC/ /100 for H=8 becomes  
REC/8/100)

For a single piece, see sales conditions on page 288 *REC/10 white PVC ecoline*



# external corners profiles

## cerfix® proangle F

Proangle F is a triangular profile indicated as a decorative element and closing of the outside corners of the tiles.

The stainless steel version with reduced base is rather suitable for the protection and finishing of the interior angles of ceramic coverings.



FMB/10 + FMBE/10 bright polished silver aluminium

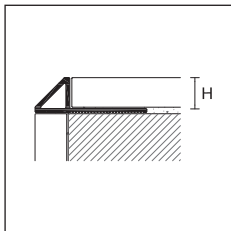

FMA/  
FMB/

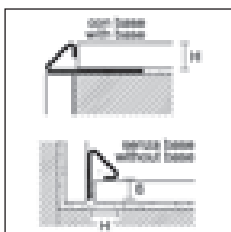

FMI/  
FMIS/

### PROANGLE F

length = 270 cm - pack 20 pcs

ART. finishing		H		
		8	10	12,5
<b>ALUMINIUM</b>				
<b>FMA/</b>	silver anodised	93025	93026	93027
	<i>euro/m</i>	<b>4,62</b>	<b>5,00</b>	<b>5,69</b>
<b>FMB/</b>	bright polished silver	93028	93029	93030
	<i>euro/m</i>	<b>7,93</b>	<b>8,75</b>	<b>9,86</b>

individually packed

### PROANGLE F

length = 270 cm - pack 20 pcs

ART. finishing		H			
		8		10	
<b>STAINLESS STEEL</b>					
		with base	without base	with base	without base
<b>FMI/</b>	stainless steel AISI 304 - DIN 1.4301	93050	93051	93052	93053
	<i>euro/m</i>	<b>9,77</b>	<b>8,75</b>	<b>10,07</b>	<b>9,06</b>
<b>FMIS/</b>	satin stainless steel AISI 304 - DIN 1.4301	93054	93055	93056	93057
	<i>euro/m</i>	<b>12,51</b>	<b>11,50</b>	<b>13,09</b>	<b>12,11</b>

individually packed

### OUTSIDE CORNER

pack 5 pcs\*

ART. finishing		H		
		8	10	12,5
<b>ALUMINIUM</b>				
<b>FMAE/</b>	silver anodised	93031	93032	93033
	<i>euro/pc</i>	<b>8,85</b>	<b>8,85</b>	<b>8,85</b>
<b>FMBE/</b>	bright polished silver	93040	93041	93042
	<i>euro/pc</i>	<b>8,85</b>	<b>8,85</b>	<b>8,85</b>

### INSIDE CORNER

pack 5 pcs\*

ART. finishing		H		
		8	10	12,5
<b>ALUMINIUM</b>				
<b>FMAI/</b>	silver anodised	93034	93035	93036
	<i>euro/pc</i>	<b>8,85</b>	<b>8,85</b>	<b>8,85</b>
<b>FMBI/</b>	bright polished silver	93043	93044	93045
	<i>euro/pc</i>	<b>8,85</b>	<b>8,85</b>	<b>8,85</b>

### END CAP

pack 5 pcs\*

ART. finishing		H		
		8	10	12,5
<b>ALUMINIUM</b>				
<b>FMAC/</b>	silver anodised	93037	93038	93039
	<i>euro/pc</i>	<b>8,85</b>	<b>8,85</b>	<b>8,85</b>
<b>FMBC/</b>	bright polished silver	93046	93047	93048
	<i>euro/pc</i>	<b>8,85</b>	<b>8,85</b>	<b>8,85</b>

### OUTSIDE CORNER

pack 5 pcs

ART. finishing		H		
		8	10	12,5
<b>STAINLESS STEEL</b>				
<b>FMIE/</b>	stainless steel AISI 304 - DIN 1.4301	93058	93059	
	<i>euro/pc</i>	<b>13,84</b>	<b>13,84</b>	
<b>FMIES/</b>	satin stainless steel AISI 304 - DIN 1.4301	93064	93065	
	<i>euro/pc</i>	<b>15,55</b>	<b>15,55</b>	

### INSIDE CORNER

pack 5 pcs

ART. finishing		H		
		8	10	12,5
<b>STAINLESS STEEL</b>				
<b>FMII/</b>	stainless steel AISI 304 - DIN 1.4301	93060	93061	
	<i>euro/pc</i>	<b>13,84</b>	<b>13,84</b>	
<b>FMIIS/</b>	satin stainless steel AISI 304 - DIN 1.4301	93066	93067	
	<i>euro/pc</i>	<b>15,55</b>	<b>15,55</b>	

### END CAP

pack 5 pcs

ART. finishing		H		
		8	10	12,5
<b>STAINLESS STEEL</b>				
<b>FMIC/</b>	stainless steel AISI 304 - DIN 1.4301	93062	93063	
	<i>euro/pc</i>	<b>12,79</b>	<b>12,79</b>	
<b>FMICS/</b>	satin stainless steel AISI 304 - DIN 1.4301	93068	93069	
	<i>euro/pc</i>	<b>14,47</b>	<b>14,47</b>	

no partial packaging for aluminium accessories

\* available upon request pack of 1 pc in blister + 1,47 Euro (for example FMAE/8 code 93031 becomes 93031/B) - Complete the article code with H measure (for example FMA/ for H=8 becomes FMA/8) - For a single piece, see sales conditions on page 288



# cerfix® proangle AX - pronivel M

Proangle AX M Design is a profile in anodised or colour-coated aluminium, which finishes the vertical edge of the coverings, accentuating the discontinuity between the wall in an elegant way.



AX/2/ silver anodised aluminium

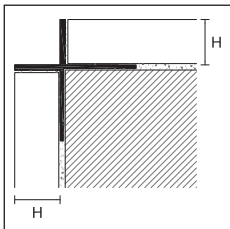

AX/2/

## PROANGLE AX- M DESIGN

length = 270 cm - pack 10 pcs

		H		
ART.	finishing	6	10	12,5
<b>ALUMINIUM</b>				
	silver anodised	13208	13209	13210
	<i>euro/m</i>	<b>8,34</b>	<b>8,34</b>	<b>8,34</b>
<b>AX/2/</b>	titanium anodised	13211	13213	13212
	colour-coated polished white RAL 9010	13215	13216	13214
	<i>euro/m</i>	<b>12,16</b>	<b>12,16</b>	<b>12,16</b>

individually packed

Pronivel M is a line of profiles designed to connect floors of different heights during the installation. Thanks to its shape, MIN/ can be also used as edging profile for the protection of 135-degree external corners of tile coverings.



MIN/10 polished stainless steel AISI 304 DIN 1.4301

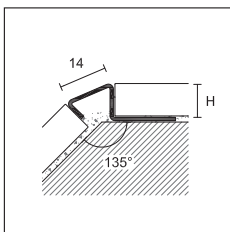

MIN/10

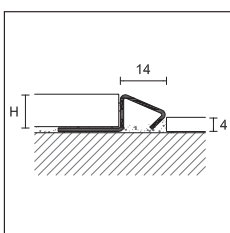

MIN/10 application for floors of different height

## PRONIVEL M

length = 270 cm - pack 10 pcs

		H	
ART.	finishing	8	10
<b>MIN/</b>	polished stainless steel AISI 304 - DIN 1.4301	93023	93024
	<i>euro/m</i>	<b>10,12</b>	<b>11,12</b>

individually packed

Complete the article code with H measure (for example AX/2/ for H=10 becomes AX/2/10)

Complete the article code with H measure (for example MIN/ for H=10 becomes MIN/10)

For a single piece, see sales conditions on page 288

# cerfix® procorner M

Procorner M is a line of protection profiles of the outside corners of wall to be applied on the surfaces of the tiles already laid. Procorner profiles are also available in self-adhesive version for a quick and easy installation.

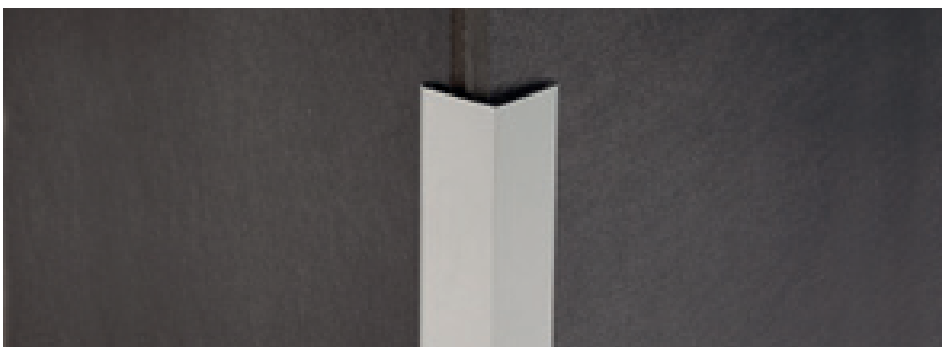

210/A silver anodised aluminium

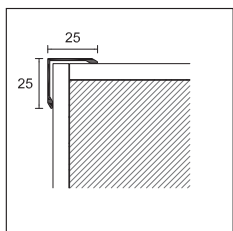

210/  
210H/A

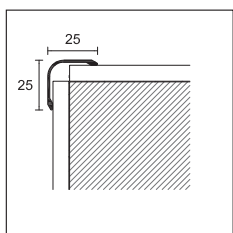

220/

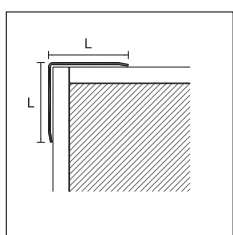

277/

Complete the article code with L measure (for example 277/SF/ for L= 20 becomes 277/SF/20)

Upon request, we can manufacture cerfix® procorner' with different dimensions. Please contact our technical department for further information.

For a single piece, see sales conditions on page 288

## PROCORNER M

length = 300 cm - pack 30 pcs

LxL

25x25

ART.	finishing		/SF	/A
<b>ALUMINIUM</b>				
	silver anodised		76068	76098
	gold anodised		-	76108
<b>210/</b>	<b>euro/m</b>		<b>5,07</b>	<b>6,45</b>
	colour-coated white RAL 9003		76128	76208
	<b>euro/m</b>		<b>6,63</b>	<b>8,00</b>

SF = not drilled A = adhesive  
individually packed

## NEW PROCORNER M

length = 300 cm - pack 30 pcs

LxL

25x25

ART.	finishing			
<b>ANTIBACTERIAL COLOUR-COATED ALUMINIUM</b>				
	colour-coated antibacterial white RAL 9003		76209	
<b>210H/A</b>	<b>euro/m</b>		<b>12,45</b>	

A = adhesive  
individually packed

## PROCORNER M

length = 300 cm - pack 30 pcs

LxL

25x25

ART.	finishing		/SF	/A
<b>ALUMINIUM</b>				
	silver anodised		77888	77894
<b>220/</b>	<b>euro/m</b>		<b>6,26</b>	<b>7,62</b>
	colour-coated white RAL 9003		77900	-
	<b>euro/m</b>		<b>7,85</b>	-

SF = not drilled A = adhesive  
individually packed

## PROCORNER M

### SILVER ANODISED ALUMINIUM

length = 300 cm - pack 30 pcs

ART.	measure LxL	code	euro/m
<b>277/SF/</b>	<b>20x20</b>	76308	<b>4,80</b>
<b>277/A/</b> adhesive	<b>20x20</b>	76309	<b>6,18</b>
<b>277/SF/</b>	<b>25x25</b>	76318	<b>5,16</b>
<b>277/A/</b> adhesive	<b>25x25</b>	76319	<b>6,53</b>
<b>277/SF/</b>	<b>30x30</b>	76328	<b>5,66</b>
<b>277/A/</b> adhesive	<b>30x30</b>	76329	<b>7,02</b>

individually packed



775/A/40 polished stainless steel AISI 304 DIN 1.4301

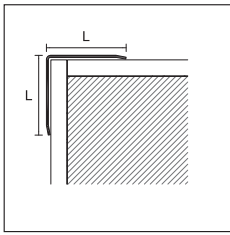

777/  
776/

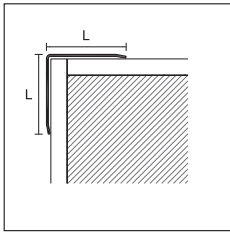

775/

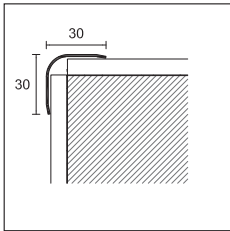

774/

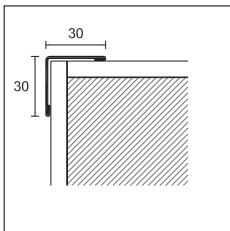

779/SF

Complete the article code with L measure (for example 777/SF/ for L=15 becomes 777/SF/15)

Upon request, we can manufacture cerfix® procorner with different dimensions. Please contact our technical department for further information.

For a single piece, see sales conditions on page 288

**PROCORNER M**

**POLISHED STAINLESS STEEL AISI 430 DIN 1.4016**

length = 300 cm - thickness = 0,60 mm

ART.	measure LxL	code	euro/m	pack
777/SF/	15x15	76888	6,01	30
777/A/ adhesive	15x15	76938	8,25	30
777/SF/	20x20	76898	7,30	30
777/A/ adhesive	20x20	76948	9,50	30
777/SF/	25x25	76908	8,53	15
777/A/ adhesive	25x25	76958	10,75	15
777/SF/	30x30	76918	9,85	20
777/A/ adhesive	30x30	76968	12,04	20

length = 200 cm - thickness = 1 mm

ART.	measure LxL	code	euro/m	pack
776/SF/	30x30	77004	13,01	20
776/A/ adhesive	30x30	77044	15,03	20
776/SF/	40x40	77014	16,77	10
776/A/ adhesive	40x40	77054	18,80	10
776/SF/	50x50	77024	19,97	10
776/A/ adhesive	50x50	77064	21,97	10

length = 270 cm - thickness = 1 mm

ART.	measure LxL	code	euro/m	pack
776/SF/	30x30	77008	13,01	10
776/A/ adhesive	30x30	77048	15,03	10
776/SF/	40x40	77018	16,77	10
776/A/ adhesive	40x40	77058	18,80	10
776/SF/	50x50	77028	19,97	5
776/A/ adhesive	50x50	77068	21,97	5

**POLISHED STAINLESS STEEL AISI 304 DIN 1.4301**

length = 270 cm - thickness = 1 mm

ART.	measure LxL	code	euro/m	pack
775/SF/	30x30	77108	16,17	10
775/A/ adhesive	30x30	77148	18,20	10
775/SF/	40x40	77118	20,62	10
775/SF/	50x50	77128	24,60	5
775/A/ adhesive	50x50	77168	26,60	5

**SATIN STAINLESS STEEL AISI 304 DIN 1.4301**

length = 270 cm - thickness = 1 mm

ART.	measure LxL	code	euro/m	pack
775/SF/	30x30	77110	20,43	10
775/SF/	50x50	77130	33,01	5

**POLISHED STAINLESS STEEL AISI 304 DIN 1.4301**

length = 270 cm - thickness = 1 mm

ART.	measure LxL	code	euro/m	pack
774/SF	30x30	77954	18,85	10

**SATIN STAINLESS STEEL AISI 304 DIN 1.4301**

length = 270 cm - thickness = 1 mm

ART.	measure LxL	code	euro/m	pack
779/SF	30x30	77106	25,96	10

SF = not drilled A = adhesive

# cerfix® procorner M - procorner P

Procorner M is a profile for the protection of the external corners of coverings. Recommended in places such as schools, offices, kindergartens and public spaces, it is available in polished brass to highlight the covering corners.

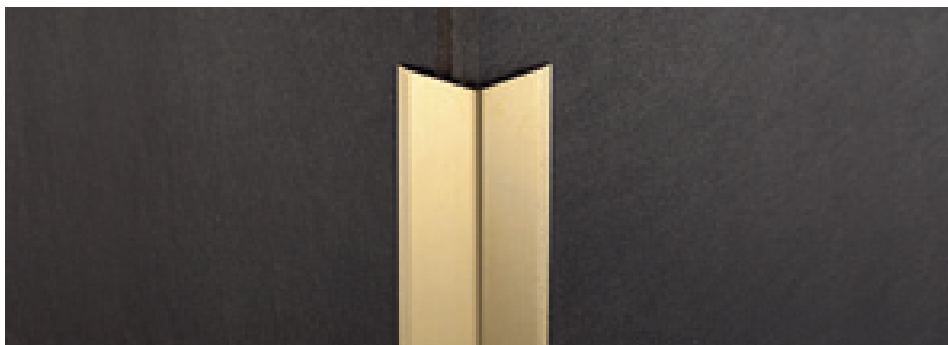

076/A/30 polished brass

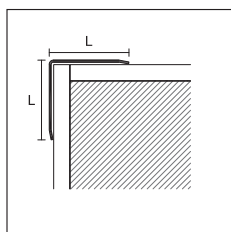

076/SF/  
076/A/

## PROCORNER M

### POLISHED BRASS

length = 270 cm - thickness = 1,00 mm

ART.	measure LxL	code	euro/m	pack
076/SF/	15x15	76800	14,19	30
076/A/ adhesive	15x15	76840	16,61	15
076/SF/	20x20	76802	17,51	15
076/A/ adhesive	20x20	76842	19,93	15
076/SF/	25x25	76806	20,84	15
076/A/ adhesive	25x25	76846	23,27	10
076/SF/	30x30	76808	23,87	10
076/A/ adhesive	30x30	76848	26,28	10

SF = not drilled    A = adhesive

Procorner P is an edge profile to protect from many issues. Recommended in environments such as schools, offices, kindergartens, public spaces, it is made of PVC soft and in bright colors to visually highlight the edges of the wall.

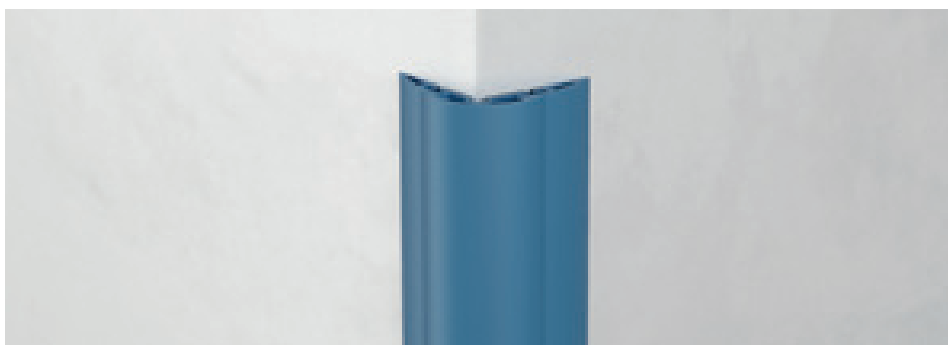

IP/40 blue soft PVC

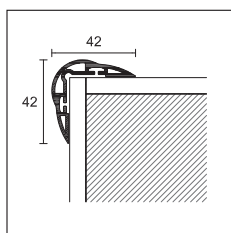

IP/40

## PROCORNER P

length = 270 cm - pack 20 pcs

ART.	finishing	LxL
<b>SOFT PVC</b>		
	white	95010
	yellow	95011
IP/40	red	95012
	blue	95013
	euro/m	4,41

Complete the article code with H measure (for example 076/SF/ for L=15 becomes 076/SF/15)

Upon request, we can manufacture cerfix® procorner with different dimensions. Please contact our technical department for further information.

Article IP/40 in PVC should be stored horizontally

For a single piece, see sales conditions on page 288

PVC Line 8610 and 8611 are a line of edging profiles in foam PVC that are impact resistant. Quick and easy to install, they are particularly suitable for DIY installations. Available in different vivid colours, they are suitable for places like schools, kindergartens and public spaces in general.



8610 white dec. 555

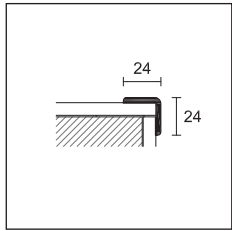

8610

**PVC LINE**

length 300 cm - pack 20/50 pcs

**FOAM PVC**

ART.	decors		decors		decors	
		518 29810		536 29830		yellow 561 29848
		520 29812		540 29832		green 562 29850
		524 29814		542 29834		light blue 563 29847
		525 29816		544 29836		red 564 29849
<b>8610</b>		528 29818		545 29838		
		530 29820		white 555 29840		
		531 29822		light grey 556 29842		
		532 29824		black 557 29844		
		534 29828		anthracite 558 29846		

pack 20 pcs

euro/m

1,35

1,39

pack 50 pcs

euro/m

1,07

1,10

no partial packaging

**PVC LINE**

length 300 cm - pack 20/50 pcs

**FOAM PVC**

ART.	decors		decors		decors		decors	
		518 29910		white 555 29940		yellow 561 29946		silver dec. 559 <b>NEW</b> 29949
<b>8611</b>		532 29924		light grey 556 29942		green 562 29948		
		542 29934		black 557 29944		light blue 563 29945		
		545 29938				red 564 29947		

pack 20 pcs

euro/m

1,46

1,49

1,77

pack 50 pcs

euro/m

1,18

1,21

1,47

no partial packaging



8610 dec. 532

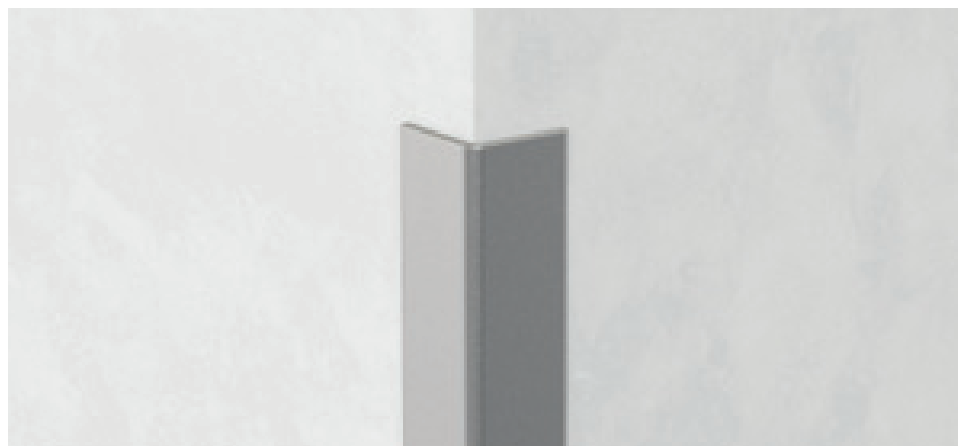

8611 silver dec. 559

Skirting board available with the same decors on page 221

# external corners profiles

## cerfix® probord

Stainless steel Probord ILN is a security profile for the outside corners of wall tiles. It can be combined with the profiles Proround M and it is recommended for the prevention of accidents and in environments where high hygienic safety is also required such as kitchens, food industries, schools etc.. The version in AISI 316 stainless steel is suitable for swimming pools, spa and in environments exposed to salt.



ILN/10 polished stainless steel AISI 304 DIN 1.4301

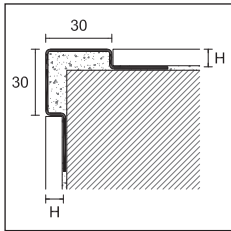

ILN/  
ILNS/  
ILNX/

### PROBORD

length = 270 cm - pack 5 pcs

ART. finishing		H		
		8	10	12,5
<b>STAINLESS STEEL</b>				
<b>ILN/</b>	polished stainless steel AISI 304 - DIN 1.4301	94997	94998	94999
	<i>euro/m</i>	<b>22,35</b>	<b>23,53</b>	<b>24,72</b>
<b>ILNS/</b>	satin stainless steel AISI 304 - DIN 1.4301	94984	94985	94986
	<i>euro/m</i>	<b>26,63</b>	<b>27,80</b>	<b>28,96</b>
<b>ILNX/</b>	stainless steel AISI 316 - DIN 1.4404	94987	94988	94989
	<i>euro/m</i>	<b>34,07</b>	<b>35,35</b>	<b>36,41</b>

individually packed

Probord IL, ILE and ILES have a rounded angle (compared to the model ILN). The fixing system with a single flange favors the correct alignment of the profile even in the presence of corners and uneven surfaces.



IL/10 polished stainless steel AISI 304 DIN 1.4301

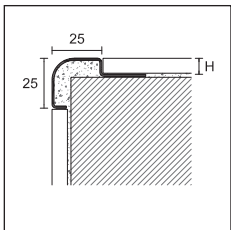

IL/

### PROBORD

length = 270 cm - pack 10 pcs

ART. finishing		H		
		8	10	12,5
<b>STAINLESS STEEL</b>				
<b>IL/</b>	stainless steel AISI 304 - DIN 1.4301	94994	94995	94996
	<i>euro/m</i>	<b>18,64</b>	<b>19,18</b>	<b>19,72</b>

individually packed

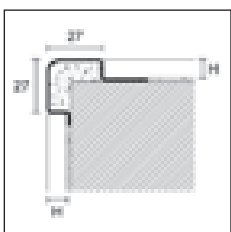

ILE/  
ILES/

### PROBORD

length = 270 cm - pack 5 pcs

ART. finishing		H		
		10		
<b>STAINLESS STEEL</b>				
<b>ILE/10</b>	polished stainless steel AISI 304 - DIN 1.4301		95002	
	<i>euro/m</i>		<b>19,67</b>	
<b>ILES/10</b>	satin stainless steel AISI 304 - DIN 1.4301		95003	
	<i>euro/m</i>		<b>21,63</b>	

individually packed

Upon request, we can manufacture ILE/ and ILES/ with different dimensions or in stainless steel AISI 316 - DIN 1.4404.

Complete the article code with H measure (for example ILN/ for H=8 becomes ILN/8)

Upon request, we can manufacture cerfix profiles, probord ILN/ and IL/ with different dimensions.

Please contact our technical department for further information.

For a single piece, see sales conditions on page 288

Cerfix Protop® is a profile for the protection and finishing of external corners of worktops and ceramic-coated kitchens. Also recommended for running boards and steps made with tiles.



TOP/A/10 silver anodised aluminium

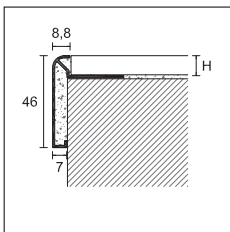

TOP/A/  
TOP/TM/

**PROTOP**

length = 270 cm - pack 10 pcs

		H	
ART.	finishing	10	12
<b>ALUMINIUM</b>			
TOP/A/	silver anodised	86050	86060
	euro/m	12,24	12,54
TOP/TM/	titanium anodised	86052	86062
	euro/m	12,24	12,54
TOP/TM/	bright satin titanium	86051	86061
	euro/m	19,97	20,22

individually packed

OUTSIDE CORNER - pack 2 pcs

		90°	135°	90°	135°
<b>ALUMINIUM</b>					
TOP/E	silver anodised	86074	86072	86074	86072
	titanium anodised	86080	86082	86080	86082
TOP/ETM	euro/pc	17,89	17,89	17,89	17,89
	bright satin titanium	86075	86073	86075	86073
TOP/ETM	euro/pc	20,76	20,76	20,76	20,76

INSIDE CORNER - pack 2 pcs

		90°	135°	90°	135°
<b>ALUMINIUM</b>					
TOP/I	silver anodised	86078	86076	86078	86076
	titanium anodised	86081	86083	86081	86083
TOP/ITM	euro/pc	17,89	17,89	17,89	17,89
	bright satin titanium	86079	86077	86079	86077
TOP/ITM	euro/pc	20,76	20,76	20,76	20,76

no partial packaging



TOP/A/10 + TOP/90/E + TOP/135/I silver anodised aluminium

Complete the article code with H measure (for example TOP/A/ for H=10 becomes TOP/A/10)

For a single piece, see sales conditions on page 288







## listellos and decorative profiles

The line of decorative listellos provides a wide variety of finishes, suitable for endless combinations and multiple aesthetic architectural tastes, from classic to contemporary; they are applicable to all environments with ceramic tiles from kitchen to bathroom, from living rooms to large commercial spaces.

Prolist is a range of decorative listellos designed to create stylish and eye-catching aesthetic effects of wall tiles. They are available in different materials and colors, and can be coordinated to the profiles of the ranges PROTRIM and Proangle to obtain elegant and sophisticated combinations.



LDB/20 bright polished silver aluminium

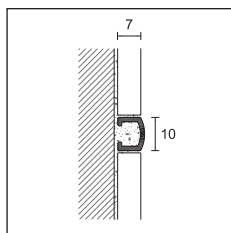
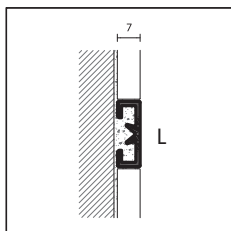

LB/B/10

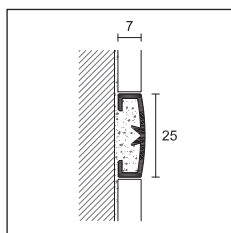

LB/A  
LB/B/25

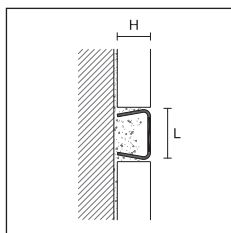

LA/I/  
LA/IS/

Complete the article code with L measure (for example LDA/ for L=10 becomes LDA/10)

Stainless steel listellos: different measures on demand - minimum 108 meters

For a single piece, see sales conditions on page 288

### PROLIST

length = 270 cm - pack 20 pcs

		L x H			
ART.	finishing	10x7	15x7	20x7	25x7
<b>ALUMINIUM</b>					
LDA/	silver anodised	93255	93215	93220	93256
	<i>euro/m</i>	<b>4,35</b>	<b>6,11</b>	<b>6,65</b>	<b>7,07</b>
LDB/	bright polished silver	93258	93219	93224	93259
LDT/	bright polished titanium	93257	93218	93223	93268
	<i>euro/m</i>	<b>6,14</b>	<b>8,05</b>	<b>8,45</b>	<b>8,86</b>
LDS/	bright satin silver	93240	93216	93221	93244
	bright satin gold	93241	93217	93222	93245
LDTM/	bright satin titanium	93266	93211	93225	93246
LDRS/	bright satin copper	93242	93267	93229	93269
	<i>euro/m</i>	<b>8,14</b>	<b>9,96</b>	<b>10,45</b>	<b>10,88</b>
LDAG/	bright scratched silver	93263	93214	93228	93243
	<i>euro/m</i>	<b>10,07</b>	<b>11,91</b>	<b>12,35</b>	<b>12,77</b>
<b>COLOUR-COATED ALUMINIUM</b>					
LDV/	white stone	-	-	93207	-
	black stone	-	-	93209	-
	<i>euro/m</i>	-	-	<b>8,45</b>	-

individually packed

### PROLIST

length = 270 cm - pack 20 pcs

		L x H	
ART.	finishing	10x7	25x7
<b>ALUMINIUM</b>			
LB/A	silver anodised	-	93270
	<i>euro/m</i>	-	<b>6,33</b>
LB/B/	bright polished silver	93252	93272
	bright polished gold	93253	93273
	<i>euro/m</i>	<b>6,14</b>	<b>8,35</b>

individually packed

### PROLIST

length = 270 cm - pack 10 pcs

		L x H		
ART.	finishing	10x10	15x10	25x10
<b>STAINLESS STEEL</b>				
LA/I/	polished stainless steel AISI 304 DIN 1.4301	93283	93284	93285
	<i>euro/m</i>	<b>6,64</b>	<b>9,92</b>	<b>14,68</b>
LA/IS/	satin stainless steel AISI 304 DIN 1.4301	93296	93297	93298
	<i>euro/m</i>	<b>8,34</b>	<b>11,63</b>	<b>16,39</b>

individually packed

# listellos and decorative profiles metal line AF - prolist x design

Metal Line AF M Design is a decorative listello in aluminium characterized by modern and minimalist lines that, thanks to its special shape, creates an elegant shadow that crosses the ceramic covering.



AF/1/10 silver anodised aluminium

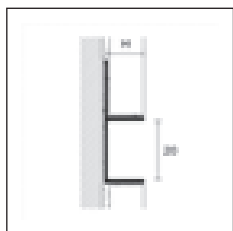

AF/1/



## METAL LINE AF - M DESIGN

length = 270 cm - pack 10 pcs

ART.	finishing	6	10	12,5
<b>ALUMINIUM</b>				
	silver anodised	13198	13199	13200
	<i>euro/m</i>	<b>8,34</b>	<b>8,34</b>	<b>8,34</b>
<b>AF/1/</b>	titanium anodised	13201	13203	13202
	colour-coated polished white RAL 9010	13196	13197	13204
	<i>euro/m</i>	<b>12,16</b>	<b>12,16</b>	<b>12,16</b>

individually packed

Complete the article code with H measure (for example AF/1/ for H=10 becomes AF/1/10)

For a single piece, see sales conditions on page 288

Prolist is available in five original finishes X Design. In anodised aluminium, X Design is characterized by a special scratched finish and original colours that allow different chromatic combinations, created for interior designers and architects by following the latest trends of modern design.

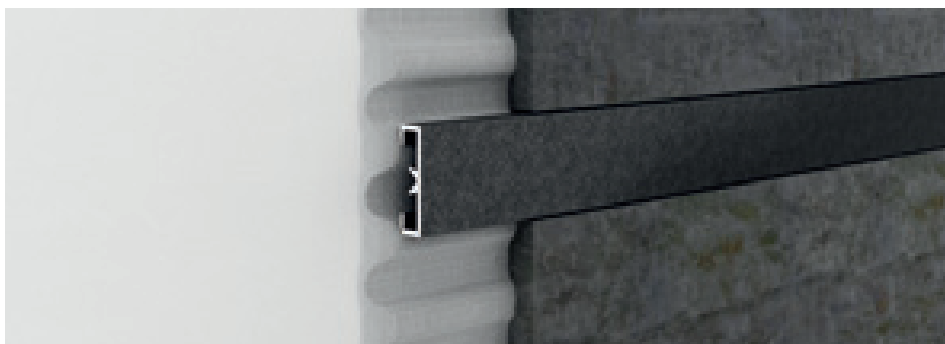

LDAD carbon anodised aluminium

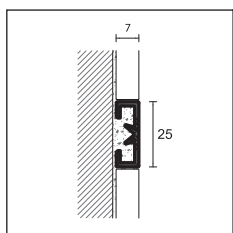

LDAD



## PROLIST - X DESIGN

length = 270 cm - pack 10 pcs

ART.	finishing	25x7
<b>ANODISED ALUMINIUM</b>		
	platinum	31320
	titanium	31322
<b>LDAD</b>	brown	31324
	dark brown	31326
	carbon	31328
	<i>euro/m</i>	<b>13,38</b>

individually packed



LED-light decorative listellos on page 232



## cerfix® C design

C Design is a line of profiles, embellished with crystals from Swarovski®. The combination of the chromium plated or gold plated profile and the crystal enhances the brightness of the lines and makes elegant any space.

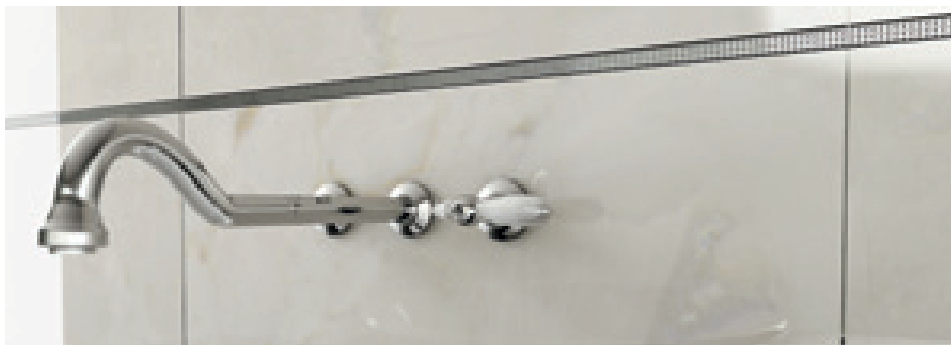

UKC/10 chromium-plated brass with crystals from Swarovski®



### PRODECOR - C DESIGN

length = 270 cm - pack 5 pcs

H

ART. finishing

10

#### CHROMIUM-PLATED BRASS

	chromium-plated + crystals from Swarovski®		13300
	<i>euro/m</i>		<b>86,63</b>
<b>DJKC/10</b>	chromium-plated + crystals from Swarovski®		13302
	<i>euro/m</i>		<b>148,73</b>

individually packed

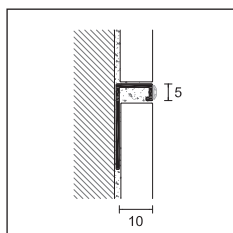

DJKC/10



DJKC/10 chromium-plated brass with crystals from Swarovski® (cod. 13300)



DJKC/10 chromium-plated brass with crystals from Swarovski® (cod. 13302)

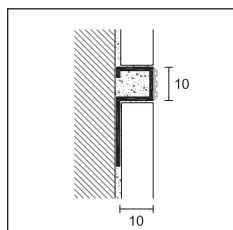

UKC/10

### PROSTYLE - C DESIGN

length = 270 cm - pack 5 pcs

H

ART. finishing

10

#### CHROMIUM-PLATED BRASS

<b>UKC/10</b>	chromium-plated + crystals from Swarovski®		13310
	<i>euro/m</i>		<b>283,59</b>

individually packed

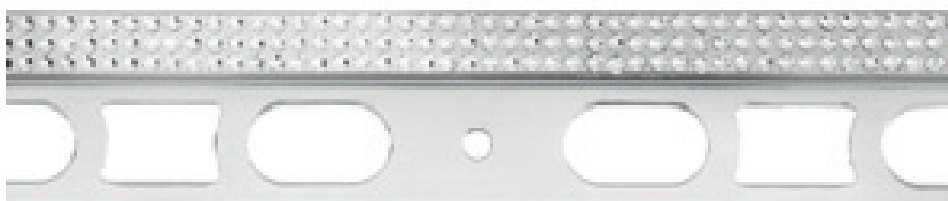

UKC/10 chromium-plated brass with crystals from Swarovski®

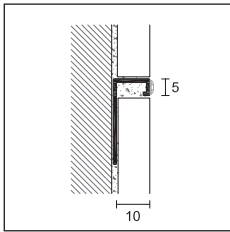

DJKGC/10

**PRODECOR - C DESIGN**

length = 270 cm - pack 5 pcs

**H****ART. finishing****10****BRASS**

**DJKGC/10** 24 kt gold plated + crystals  
from Swarovski® 

*euro/m*

13402

**195,41**

individually packed

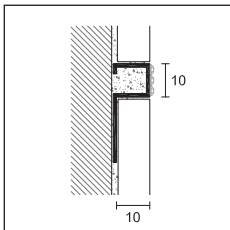
*DJKGC/10 24 kt gold plated brass + crystals from Swarovski®*

UKGC/10

**PROSTYLE - C DESIGN**

length = 270 cm - pack 5 pcs

**H****ART. finishing****10****BRASS**

**UKGC/10** 24 kt gold plated + crystals  
from Swarovski® 

*euro/m*

13410

**348,12**

individually packed

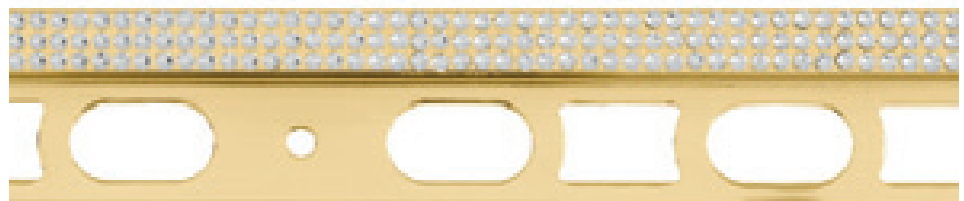
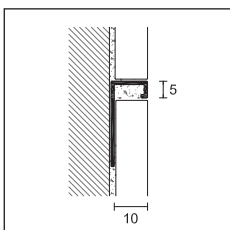
*UKGC/10 24 kt gold plated brass + crystals from Swarovski®*

DJKGC/10

**PRODECOR - C DESIGN**

length = 270 cm - pack 5 pcs

**H****ART. finishing****10****BRASS**

**DJKGC/10** 24kt gold plated 

*euro/m*

12902

**61,95**

individually packed

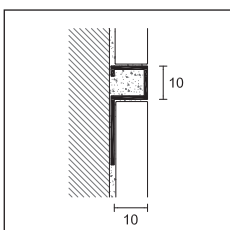

UKGC/10

**PROSTYLE - C DESIGN**

length = 270 cm - pack 5 pcs

**H****ART. finishing****10****BRASS**

**UKGC/10** 24kt gold plated 

*euro/m*

12910

**69,30**

individually packed





## internal corners profiles

A line of profiles that fits the perimetric junction between floor and wall. Created for the elimination of 90° corners and applicable to installed or to be installed floors, ensure high hygienic efficiency in private and public environments such as hospitals, food industries, SPA, swimming pools and industrial kitchens.

# internal corners profiles

## cerfix® proround

Proround M in aluminum is a connection profile between floor and wall. The current requirements for sanitary maintenance required by European standards, provide in fact the elimination of the 90° to avoid any deposit of dirty and possible sources of bacteria, creating a curvature to facilitate cleaning.



GA/10 silver anodised aluminium

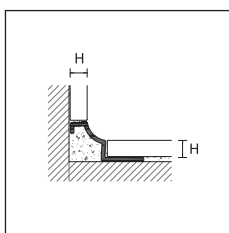

GA/4

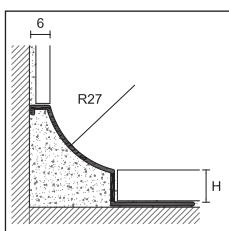

GA/8-10-12  
GV/

Complete the article code with H measure (for example GA/ for H=8 becomes GA/8)

Items GV available in different colours on demand - minimum quantity 540 meters per colour.

For a single piece, see sales conditions on page 288

### PROROUND M

length = 270 cm - pack 10 pcs

		H			
ART.	finishing	4,5	8	10	12
<b>ALUMINIUM</b>					
GA/	silver anodised	95730	95031	95032	95033
	euro/m	7,36	10,03	10,14	10,28
GV/	colour-coated white RAL 9003	-	95071	95072	95073
	euro/m	-	11,82	11,96	12,09

individually packed- GA/4 packaging 20 pcs

### OUTSIDE CORNER

pack 5 pcs

		H	
ART.	finishing	4,5	8 - 10 - 12
<b>ALUMINIUM</b>			
GTA/E	silver anodised	-	95075
	euro/pc	-	9,94
GTV/E	colour-coated white RAL 9003	-	95083
	euro/pc	-	9,98

### INSIDE CORNER

pack 5 pcs

		H	
ART.	finishing	4,5	8 - 10 - 12
<b>ALUMINIUM</b>			
GTA/I	silver anodised	-	95077
	euro/pc	-	9,94
GTV/I	colour-coated white RAL 9003	-	95085
	euro/pc	-	9,98

no partial packaging



GTA/E silver anodised aluminium



GTA/I silver anodised aluminium

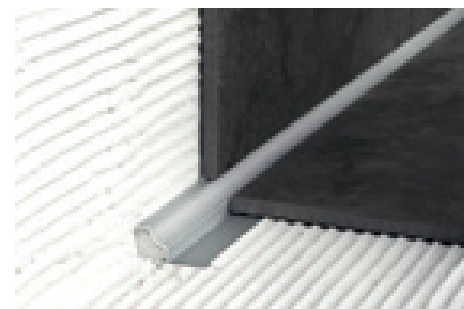

GA/4 silver anodised aluminium



Proround M GAN/ is a profile in aluminum for the connection between floor and wall, characterized by a 17-mm radius.

GVNH/ boasts the certified antibacterial technology (according to the internationally recognized laboratory test JIS Z 2801:2000) which reduces the presence of the most dangerous bacteria up to 99%, thus assuring the best hygiene over time.

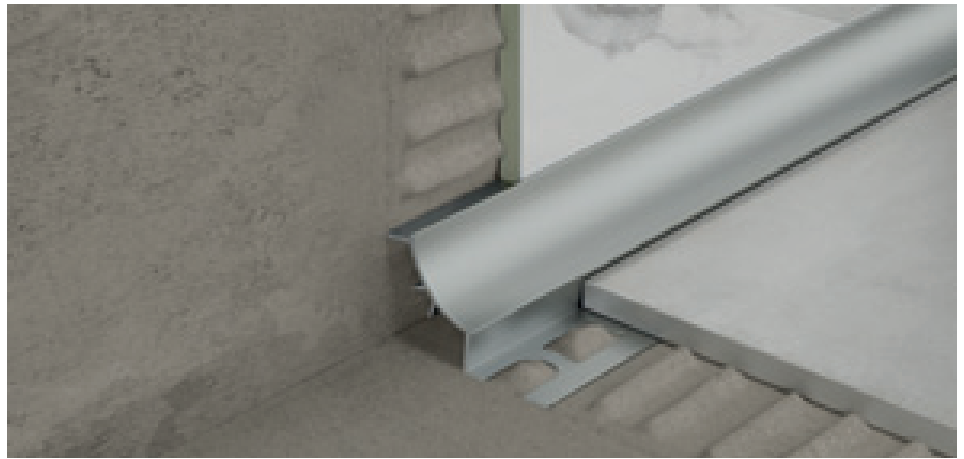

GAN/10 silver anodised aluminium

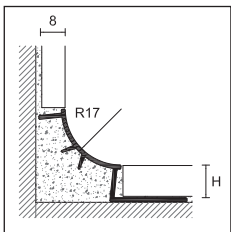

GAN/  
GVNH/

**NEW PROROUND M**

length = 270 cm - pack 10 pcs		H		
ART.	finishing	8	10	12,5
<b>ALUMINIUM</b>				
GAN/	silver anodised	95034	95035	95036
	<i>euro/m</i>	<b>8,15</b>	<b>8,27</b>	<b>8,41</b>
GVNH/	colour-coated white RAL 9003 antibacterial	95037	95038	95039
	<i>euro/m</i>	<b>9,93</b>	<b>10,05</b>	<b>10,19</b>

individually packed

OUTSIDE/INSIDE/TRIAXIAL CORNER/END CAP

pack 12 pcs		for all H			
ART.	finishing	GTP/E	GTP/I	GTP/T	GTP/C
<b>POLYPROPYLENE</b>					
	colour-coated silver	95121	95122	95123	95124
	<i>euro/pc</i>	<b>5,22</b>	<b>5,22</b>	<b>5,22</b>	<b>5,22</b>
	colour-coated white RAL 9003	95125	95126	95127	95128
	<i>euro/pc</i>	<b>5,22</b>	<b>5,22</b>	<b>5,22</b>	<b>5,22</b>

no partial packaging

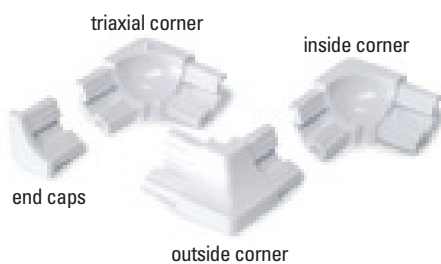

GTP/E silver colour-coated polypropylene

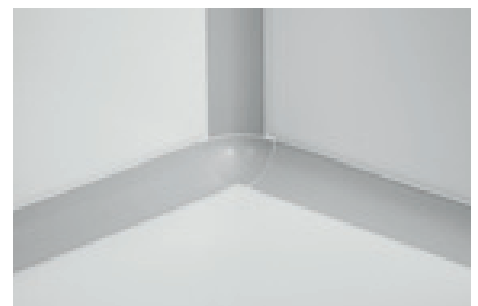

GTP/T silver colour-coated polypropylene

# internal corners profiles

## cerfix® proround

Stainless steel Proround M is a connection profile to be used in situations that require a particular level of sanitary protection (eg, medical, food industry, swimming pools, spas, industrial kitchens, hospitals, etc.). Specifically, the version in quality AISI 316 DIN 1.4404 offers characteristics of superior resistance to corrosion and is therefore recommended for use in areas subjected to higher chemical attacks, and sea zones.



GIN/10 + ILN/10 polished stainless steel AISI 304 DIN 1.4301

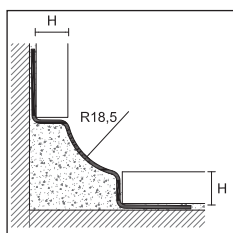

GIN 8/10/11

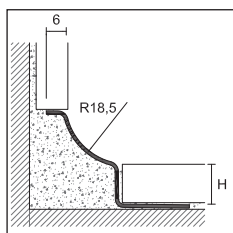

GIN/SA

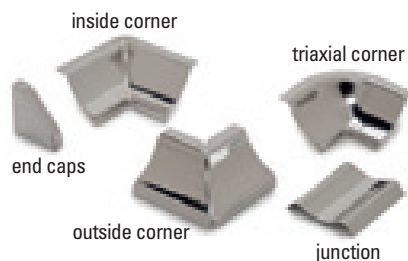

### PROROUND M

length = 270 cm - pack 10 pcs

		H				
ART.	finishing	8	10	11	12,5	15
<b>STAINLESS STEEL</b>						
GIN/	polished stainless steel AISI 304 DIN 1.4301	95046	95047	95045	-	-
	<i>euro/m</i>	17,87	18,25	18,44	-	-
GINS/	satin stainless steel AISI 304 DIN 1.4301	95050	95051	95057	-	-
	<i>euro/m</i>	21,06	21,47	21,67	-	-
GINX/	stainless steel AISI 316 DIN 1.4404	95054	95055	-	-	-
	<i>euro/m</i>	21,60	21,99	-	-	-

individually packed

### PROROUND M

length = 270 cm - pack 10 pcs

		H				
ART.	finishing	8	10	11	12,5	15
<b>STAINLESS STEEL</b>						
GIN/SA	polished stainless steel AISI 304 DIN 1.4301	-	<b>NEW</b> 95044	-	95048	95049
	<i>euro/m</i>	-	14,18	-	18,64	19,29
GINS/SA	satin stainless steel AISI 304 DIN 1.4301	-	-	-	95052	-
	<i>euro/m</i>	-	-	-	21,86	-
GINX/SA	stainless steel AISI 316 DIN 1.4404	-	-	-	95056	-
	<i>euro/m</i>	-	-	-	22,47	-

individually packed

### OUTSIDE CORNER-E

pack 5 pcs		for all H		pack 5 pcs		for all H	
ART.	finishing			ART.			
<b>STAINLESS STEEL</b>							
GTIN/E	polished stainless steel AISI 304 DIN 1.4301	95059		GTIN/I	95058		
	<i>euro/pc</i>	7,14			7,14		
GTINS/E	satin stainless steel AISI 304 DIN 1.4301	95063		GTINS/I	95062		
	<i>euro/pc</i>	9,56			9,56		
GTINX/E	stainless steel AISI 316 DIN 1.4404	95067		GTINX/I	95066		
	<i>euro/pc</i>	7,98			7,98		

### TRIAXIAL CORNER-T

pack 5 pcs		for all H		pack 5 pcs		for all H	
ART.	finishing			ART.			
GTIN/T	polished stainless steel AISI 304 DIN 1.4301	95060		GTIN/G	95061	GTIN/C	95040
	<i>euro/pc</i>	7,14			7,14		7,14
GTINS/T	satin stainless steel AISI 304 DIN 1.4301	95064		GTINS/G	95065	GTINS/C	95041
	<i>euro/pc</i>	9,56			9,56		9,56
GTINX/T	stainless steel AISI 316 DIN 1.4404	95068		GTINX/G	95069	GTINX/C	95042
	<i>euro/pc</i>	7,98			7,98		7,98

### JUNCTION-G

### END CAPS

Complete the article code with H measure (for example GIN/ for H=8 becomes GIN/8)

Cerfix® Proround M in stainless steel:  
other measures on demand - minimum quantity 540 meters

For a single piece, see sales conditions on page 288

no partial packaging

Proround P in non-toxic PVC and impact resistant is a connection profile between floor and wall. The current requirements for sanitary maintenance required by European standards, provide in fact the elimination of the 90 ° to avoid any deposit of dirty and possible sources of bacteria, creating a curvature to facilitate cleaning. Models with a single anchor flange allow to be used as a connection between the laying floors and walls with different thickness.

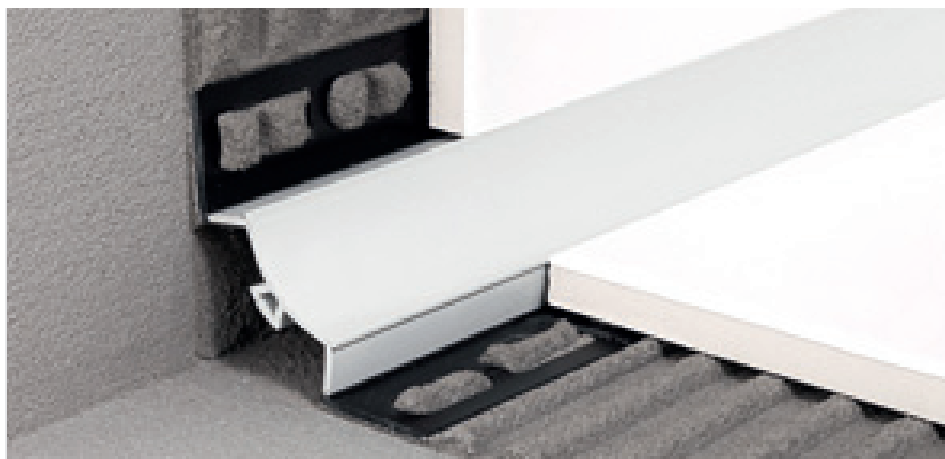

GP/10 white co-extruded PVC

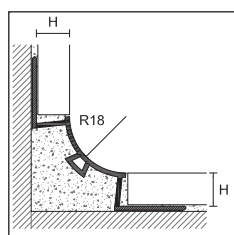

GP/

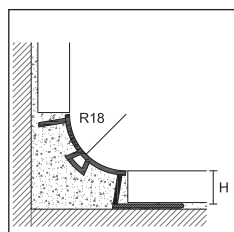

GPU/

**PROROUND P**

length = 270 cm - pack 20 pcs

		H		H	
ART.		GP/		GPU/	
<b>finishing</b>		8	10	10	12,5
<b>CO-EXTRUDED PVC</b>					
white		95800	95801	95804	95803
light grey RAL 7035		95805	95806	-	-
stone grey RAL 7030		95810	95811	-	-
beige grey RAL 1019		95815	95816	-	-
<b>euro/m</b>		<b>3,99</b>	<b>4,19</b>	<b>4,15</b>	<b>4,35</b>

**INSIDE/OUTSIDE/TRIAXIAL CORNER/END CAP**

pack 12 pcs

for all H

ART.		GTP/E	GTP/I	GTP/T	GTP/C
<b>POLYPROPYLENE</b>					
white		95852	95851	95850	95853
light grey RAL 7035		95862	95861	95860	95863
stone grey RAL 7030		95872	95871	95870	95873
beige grey RAL 1019		95882	95881	95880	95883
<b>euro/pc</b>		<b>2,26</b>	<b>2,26</b>	<b>2,26</b>	<b>2,26</b>

no partial packaging

Complete the article code with H measure (for example GP/ for H=8 becomes GP/8)

For a single piece, see sales conditions on page 288



GTP/E RAL 7035 light grey polypropylene

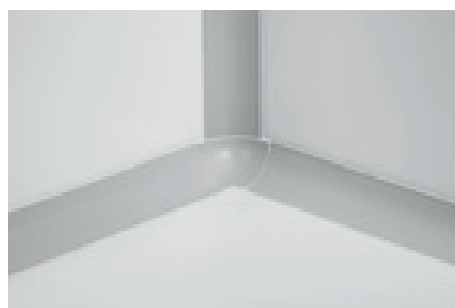

GTP/T RAL 7035 light grey polypropylene

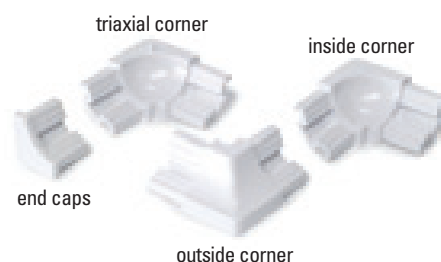

# internal corners profiles

## cerfix® proround

Proround M GIC/ and Proint PIN/ are two stainless steel profiles with rounded shape for the connection of floors and walls, to be used in those spaces where special hygiene protection is required.

The shape of GIC/ is particularly versatile thanks to the internal fixing flange.

The shape of PIN/ facilitates the corner connection of floors and walls, thus guaranteeing the expansion between the two surfaces.



GIC/8 polished stainless steel AISI 304 DIN 1.4301

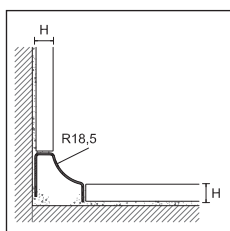

GIC/

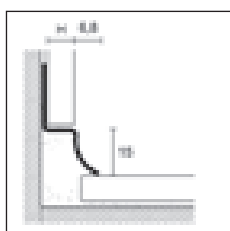
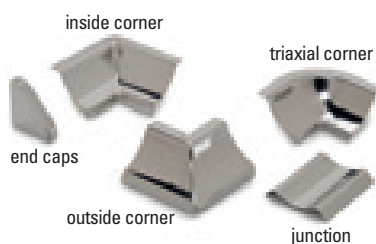

PIN/

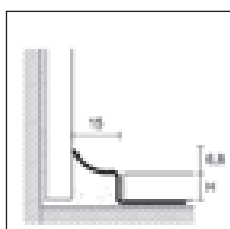

PIN/

Complete the article code with H measure (for example GIC/ for H=8 becomes GIC/8)

We can create profiles Cerfix Proround GIC/ with sizes on request, for floors and coverings of different thickness. Contact our technical department for more informations.

For a single piece, see sales conditions on page 288

### PROROUND M

length = 270 cm - pack 5 pcs

<b>ART.</b>	<b>finishing</b>	<b>8</b>
<b>STAINLESS STEEL</b>		
<b>GIC/</b>	polished stainless steel AISI 304 DIN 1.4301	95140
	<i>euro/m</i>	<b>18,27</b>

OUTSIDE CORNER-E		INSIDE CORNER-I	
pack 5 pcs	for all H	pack 5 pcs	for all H
<b>ART.</b>	<b>finishing</b>	<b>ART.</b>	
<b>STAINLESS STEEL</b>			
<b>GTIN/E</b>	polished stainless steel AISI 304 DIN 1.4301	95059	<b>GTIN/I</b>
	<i>euro/pc</i>	<b>7,14</b>	95058
			<b>7,14</b>
no partial packaging			

TRIAXIAL CORNER-T		JUNCTION-G	END CAPS
pack 5 pcs	for all H	pack 5 pcs	for all H
<b>ART.</b>	<b>finishing</b>	<b>ART.</b>	<b>ART.</b>
<b>STAINLESS STEEL</b>			
<b>GTIN/T</b>	polished stainless steel AISI 304 DIN 1.4301	95060	<b>GTIN/G</b>
	<i>euro/pc</i>	<b>7,14</b>	95061
			<b>GTIN/C</b>
			95040
			<b>7,14</b>
no partial packaging			

### PROINT

length = 270 cm - pack 10 pcs

<b>ART.</b>	<b>finishing</b>	<b>10</b>	<b>H</b>	<b>12,5</b>
<b>STAINLESS STEEL</b>				
<b>PIN/</b>	polished stainless steel AISI 304 - DIN 1.4301	85392		85394
	<i>euro/m</i>	<b>10,14</b>		<b>10,52</b>
individually packed				



PIN/10 polished stainless steel AISI 304 DIN 1.4301

Proint PIA/ and PI/ are two line of profiles in aluminium and PVC, suitable as perimetral connection during the installation of the wall covering and the floor or as perimetral expansion joint.

The use of Proint PIA/ and PI/ allows to avoid the use of silicone for sealing and, in addition to the aesthetic advantage, it guarantees a high hygiene over time.

The special sections of Proint facilitate the corner connection between the wall covering and the floor, thus guaranteeing the expansion between the two surfaces.



PIA/9 silver anodised aluminium

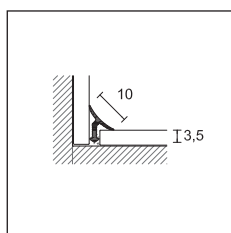

PIA/3

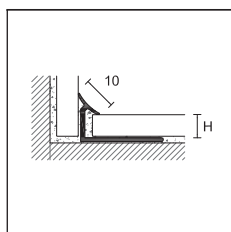

PIA/  
PI/

**PROINT**

length = 270 cm - pack 20 pcs

		H			
ART.	finishing	3,5	7	9	12
<b>ALUMINIUM</b>					
PIA/	silver anodised	95431	95430	95432	95429
	euro/m	4,99	6,16	6,46	7,02

individually packed

**PROINT**

length = 270 cm - pack 20 pcs

		H	
ART.	finishing	7	9
<b>CO-EXTRUDED PVC</b>			
PI/	snow white	95396	95398
	white	95400	95402
	cream white RAL 9001	-	95406
	ivory RAL 1015	-	95418
	beige grey RAL 1019	-	95410
	stone grey RAL 7030	-	95422
	ash grey RAL 7038	-	95433
	light grey RAL 7035	-	95414

<b>pack 20 pcs</b>		
euro/m	1,28	1,39
<b>pack 100 pcs</b>		
euro/m	1,05	1,16

no partial packaging - to order the pack of 100 pcs, mark /100 after article code

Complete the article code with H measure (for example PIA/ for H=7 becomes PIA/7)

Items PI/ available in different colours on demand - minimum quantity 2700 meters per colour

For a single piece, see sales conditions on page 288



PI/9 white co-extruded PVC



PIA/3 silver anodised aluminium

## cerfix® proround

Proround B in aluminium or PVC are perimetral connection profiles to be used between floors and walls, specially designed for the application on already-laid surfaces. These profiles are the best solution for renovations and to be compliant with hygienic regulations. BLAH/ boasts the certified antibacterial technology (according to the internationally recognized laboratory test JIS Z 2801:2000) which reduces the presence of the most dangerous bacteria up to 99%, thus assuring the best hygiene over time.



BLA/20 silver anodised aluminium

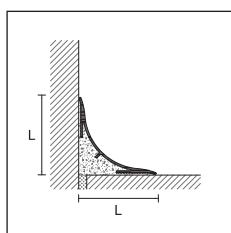

BLA/  
BLAH/

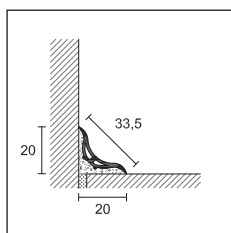

BL/20

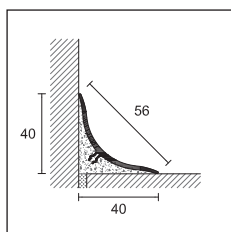

BL/40

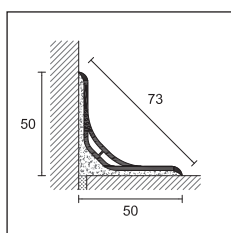

BL/50

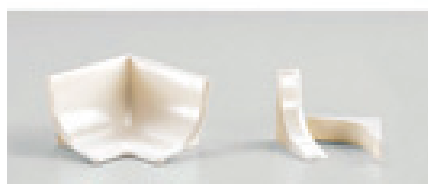

polypropylene accessories

### PROROUND B

length = 270 cm - pack 20 pcs

LxL

ART.	finishing		20x20	40x40	50x50
<b>ALUMINIUM</b>					
BLA/	silver anodised		95570	95580	-
	euro/m		6,24	8,17	-
<b>ANTIBACTERIAL COLOUR-COATED ALUMINIUM</b>					
BLAH/	colour-coated white RAL 9003 antibacterial		95572	95582	-
	euro/m		9,54	10,89	-

individually packed

### PROROUND B

length = 270 cm - pack 20 pcs

LxL

ART.	finishing		20x20	40x40	50x50
<b>PVC</b>					
BL/	white		95550	95500	95551
	euro/m		4,04	5,92	8,55

### POLYPROPYLENE ACCESSORIES PACK

8 pcs

4 pcs

4 pcs

#### OUTSIDE CORNER IN POLYPROPYLENE

GBL/ /E	silver		95574	95584	-
	white		95556	95510	95552
	euro/pc		3,09	4,10	4,35

#### INSIDE CORNER IN POLYPROPYLENE

GBL/ /I	silver		95576	95586	-
	white		95557	95512	95553
	euro/pc		3,09	4,10	4,35

#### TRIAXIAL CORNER IN POLYPROPYLENE

GBL/ /T	silver		-	95588	-
	white		-	95511	95554
	euro/pc		-	4,10	4,35

#### RIGHT-LEFT END CAPS IN POLYPROPYLENE

GBL/ /C	silver		95578	95590	-
	white		95558	95513	95555
	euro/pc		3,09	3,92	4,14

no partial packaging - article GBL/ /C pack of 16 pcs (20x20) and 8 pcs (40x40 and 50x50)

Complete the article code with L measure (for example BLA/ for L= 20 becomes BLA/20)  
For a single piece, see sales conditions on page 288

Proround B in stainless steel are perimetral connection profiles to be used between floors and walls, specially designed for the application on already-laid surfaces. These profiles are the best solution for renovations and to be compliant with hygienic regulations.

Stainless steel is particularly resistant to the attack of organic and inorganic agents and, therefore, it is suitable in spaces such as hospitals, food and chemical industries.



BI/40 stainless steel AISI 304 DIN 1.4301

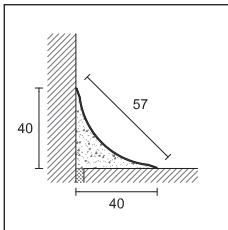

BI/40  
BI/40/A

**PROROUND B**

length = 270 cm - pack 20 pcs		LxL
ART.	finishing	40x40
<b>STAINLESS STEEL</b>		
<b>BI/40</b>	stainless steel AISI 304 DIN 1.4301 <i>euro/m</i>	94992 <b>14,10</b>
<b>BI/40/A adhesive</b>	stainless steel AISI 304 DIN 1.4301 <i>euro/m</i>	94993 <b>17,47</b>

**POLYPROPYLENE MATCHING CHROMIUM FINISH PACK 4 PCS**

**OUTSIDE CORNER IN POLYPROPYLENE**

<b>GTL/E</b>	polypropylene chromium effect <i>euro/pc</i>	95515 <b>5,99</b>
--------------	--	----------------------

**INSIDE CORNER IN POLYPROPYLENE**

<b>GTL/I</b>	polypropylene chromium effect <i>euro/pc</i>	95517 <b>5,99</b>
--------------	--	----------------------

**TRIAXIAL CORNER IN POLYPROPYLENE**

<b>GTL/T</b>	polypropylene chromium effect <i>euro/pc</i>	95516 <b>5,99</b>
--------------	--	----------------------

**RIGHT-LEFT END CAPS IN POLYPROPYLENE**

<b>GTL/C</b>	polypropylene chromium effect <i>euro/pc</i>	95518 <b>5,99</b>
--------------	--	----------------------

no partial packaging

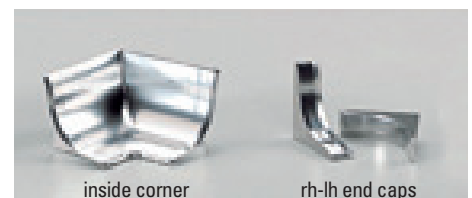

For a single piece, see sales conditions on page 288





## linear shower drains and systems for bathrooms

Profilpas offers a wide range of solutions for bathrooms which combine functionality and modern design. In particular, Profilpas bathroom systems allow the creation of floor-level showers, with a wide selection of linear shower drains - like PP Drain Aqua, Thin Drain, Slim Drain and Smart Drain, all customizable with different grates - and Q-Drain, available in several models. Profilpas bathroom range also includes Glass Profile, a line of profiles for the insertion of glass walls and the finishing of the shower surface, designed to compensate the 2% slope.



## PP Drain Aqua

### PPdrain | Aqua

The linear shower drains PP Drain Aqua, made of stainless steel AISI 316 and provided with a patented removable siphon in antibacterial ABS, are a perfect synthesis of beauty and practicality. Profilpas has taken care of every aspect of their design, production and quality control, to offer a product that is always efficient and aesthetically perfect.

The linear shower drains PP Drain Aqua, composed of a single piece without welds, distinguish for their design and functionality that make them elegant, simple to install and easy to clean. Each part of the shower drain is studied in detail, to contain in few components all that is needed to guarantee the maximum ease of installation and maintenance.

#### Aesthetics



Elegant and exclusive design, customisable with a wide range of covers and finishes.

#### Removable siphon

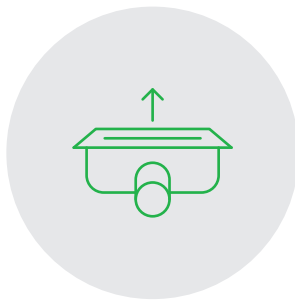

The siphon is simple to remove and can be easily inspected, for the maximum efficiency.

#### Ease of installation



The assembly and the adjustment of the shower drain are simplified, for a simple and quick installation.

#### Cleanliness and hygiene



The removable siphon in antibacterial ABS simplifies the maintenance and allows a quick and efficient cleanliness.



## PP Drain Aqua

The essentiality of the linear shape of the shower drain, combined to the beauty of the multiple finishes, allows to offer an aesthetically perfect solution, able to adapt to any kind of design and to any material (porcelain stoneware, marble, mosaic, natural stone...).

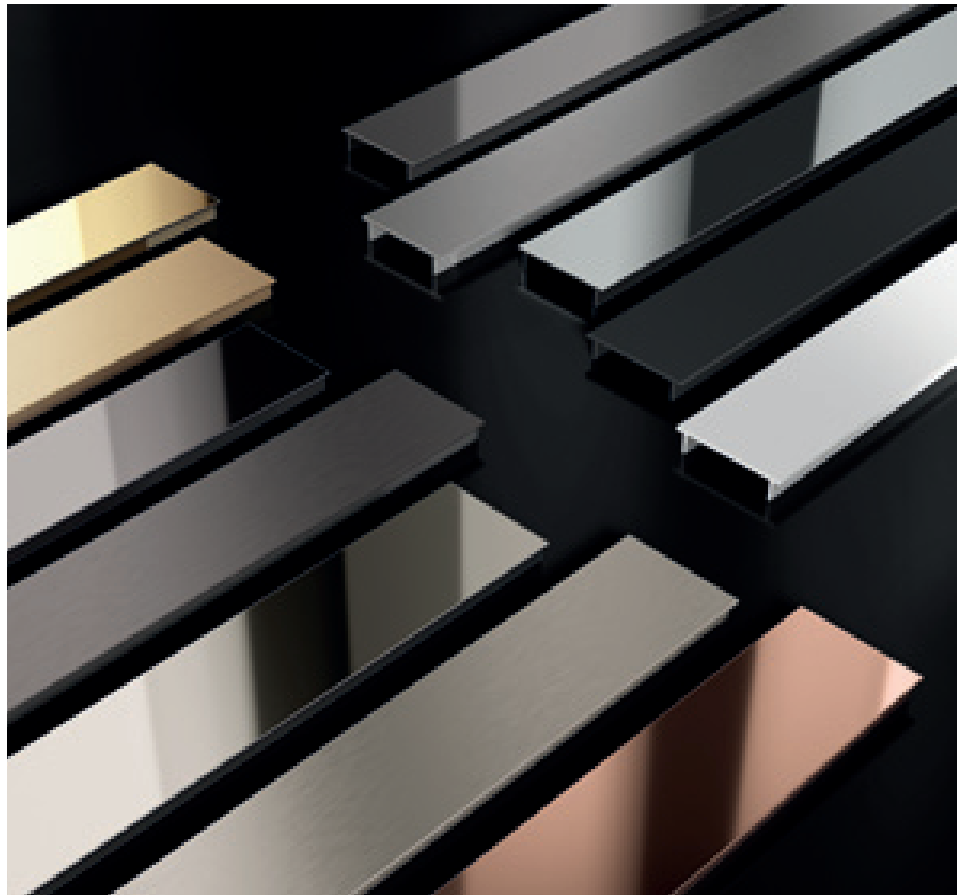

# PP Drain Aqua

With PP Drain Aqua linear shower drains, maintenance and cleaning are fully simplified. The siphon, made of antibacterial ABS, can be removed and inspected completely. Furthermore, the AISI 316 stainless steel shower drain base is composed of a single piece without welds and sharp edges for the best hygiene and efficiency. Studied to minimize installation times, they are equipped with a pre-glued waterproofing membrane, supports from 6 to 18 mm for the height adjustment of the covers and bases in polystyrene foam.



PP Drain Aqua

**NEW** PP DRAIN AQUA - shower drain base with siphon

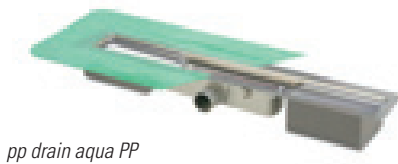

pp drain aqua PP

ART.	finishing		L					
			60 cm	70 cm	80 cm	90 cm	100 cm	120 cm
<b>STAINLESS STEEL</b>								
PP/	stainless steel		22100	22101	22102	22103	22104	22105
	AISI 316 DIN 1.4404							
	euro/pc		150,92	158,40	171,05	178,53	189,09	204,05

**NEW** PP DRAIN AQUA - shower drain base with direct drainage diam. 50 mm

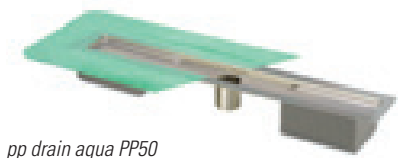

pp drain aqua PP50

ART.	finishing		L					
			60 cm	70 cm	80 cm	90 cm	100 cm	120 cm
<b>STAINLESS STEEL</b>								
PP50/	stainless steel		22106	22107	22108	22109	22110	22111
	AISI 316 DIN 1.4404							
	euro/pc		115,17	122,54	135,30	142,67	153,34	168,30

Shower drain base with direct drainage diam. 40 mm available upon request.

cover<sup>1</sup>

frame<sup>2</sup>

ABS supports

hair catcher filter

removable top in antibacterial ABS

removable siphon in antibacterial ABS

waterproofing membrane

single-piece base in stainless steel AISI 316

base in polystyrene

drain in antibacterial ABS

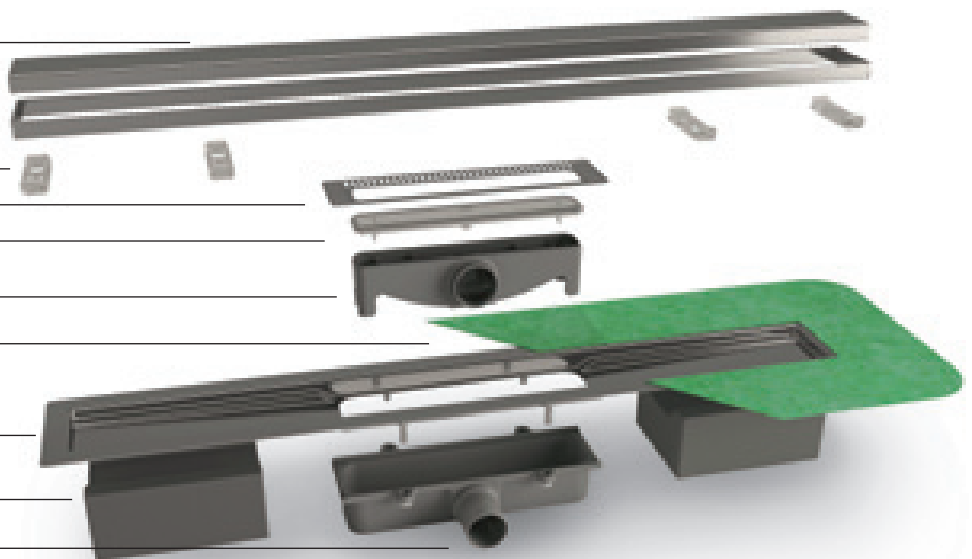

<sup>1</sup> Different types of cover available.

<sup>2</sup> The frame is present in Classic Cover model. The other covers are not equipped with frame.

Complete the article code with L measure (for example PP/ for L = 70 becomes PP/70)

# PP Drain Aqua

Classic Cover, in polished or satin stainless steel AISI 316, is available in different lengths (from 60 to 120 cm). It includes the frame and the adjustment supports from 6 to 18 mm, and it is reversible: if turned upside down, it becomes tileable (up to 12 mm), thus creating aesthetic continuity with the bathroom covering.



PP Drain Aqua - Classic Cover polished stainless steel AISI 316 - DIN 1.4404

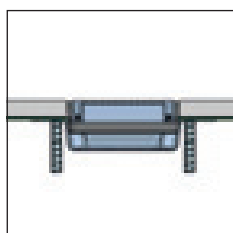

Classic Cover

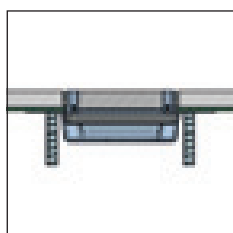



Classic Cover tileable



Classic Cover satin stainless steel AISI 316 DIN 1.4404

**NEW CLASSIC COVER - tiles thickness from 6 to 18 mm**

		L						
ART.	finishing	60 cm	70 cm	80 cm	90 cm	100 cm	120 cm	
<b>STAINLESS STEEL</b>								
	polished stainless steel AISI 316 DIN 1.4404		22112	22113	22114	22115	22116	22117
<b>XPC/</b>	satin stainless steel AISI 316 DIN 1.4404		22118	22119	22120	22121	22122	22123
	<b>euro/pc</b>		<b>91,08</b>	<b>98,89</b>	<b>108,35</b>	<b>127,05</b>	<b>134,20</b>	<b>150,15</b>

Classic Cover is reversible, if turned upside down it becomes tileable (with a thickness up to 12 mm).



PP Drain Aqua - Classic Cover satin stainless steel AISI 316 - DIN 1.4404

Complete the article code with L measure (for example XPC/ for L = 70 becomes XPC/70)

## PP Drain Aqua

Flat Cover, available in several finishes and different lengths (from 60 to 120 cm), stands out for the perfectly flat and linear design. It is provided with adjustment supports that allow it to be adapted to tiles with thickness from 6 to 18 mm.



PP Drain Aqua - Flat Cover matt black colour-coated aluminium

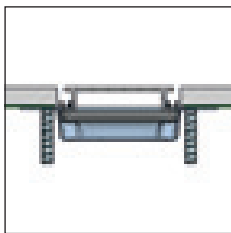

Flat Cover aluminium

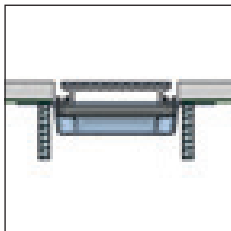













Flat Cover aluminium + stainless steel



Flat Cover chromium-plated stainless steel

### NEW FLAT COVER - tiles thickness from 6 to 18 mm

ART.	finishing		L					
			60 cm	70 cm	80 cm	90 cm	100 cm	
<b>ALUMINIUM + STAINLESS STEEL</b>								
XPF/	polished stainless steel AISI 316 DIN 1.4404		22136	22137	22138	22139	22140	22141
	satin stainless steel AISI 316 DIN 1.4404		22142	22143	22144	22145	22146	22147
	<i>euro/pc</i>		<b>57,97</b>	<b>63,36</b>	<b>69,41</b>	<b>82,39</b>	<b>90,09</b>	<b>101,31</b>
<b>ALUMINIUM + CHROMIUM-PLATED STAINLESS STEEL</b>								
XPF/	chromium-plated stainless steel AISI 316 DIN 1.4404		22261	22262	22263	22264	22265	-
	<i>euro/pc</i>		<b>90,64</b>	<b>96,03</b>	<b>112,97</b>	<b>125,95</b>	<b>125,95</b>	-
<b>COLOUR-COATED ALUMINIUM</b>								
XPF/	matt white		22148	22149	22150	22151	22152	-
	matt black		22154	22155	22156	22157	22158	-
	<i>euro/pc</i>		<b>49,39</b>	<b>51,48</b>	<b>53,57</b>	<b>62,37</b>	<b>64,57</b>	-
<b>ALUMINIUM + STAINLESS STEEL</b>								
XPF/	polished nickel		22226	22227	22228	22229	22230	-
	satin nickel		22231	22232	22233	22234	22235	-
	polished pink gold		22236	22237	22238	22239	22240	-
	<i>euro/pc</i>		<b>161,48</b>	<b>166,76</b>	<b>172,81</b>	<b>185,90</b>	<b>193,49</b>	-
	polished graphite		22241	22242	22243	22244	22245	-
	satin graphite		22246	22247	22248	22249	22250	-
	<i>euro/pc</i>		<b>172,37</b>	<b>177,65</b>	<b>183,70</b>	<b>196,79</b>	<b>204,38</b>	-
	polished gold		22251	22252	22253	22254	22255	-
satin gold		22256	22257	22258	22259	22260	-	
	<i>euro/pc</i>		<b>253,99</b>	<b>259,38</b>	<b>265,43</b>	<b>278,41</b>	<b>286,11</b>	-



Flat Cover

Complete the article code with L measure  
(for example XPF/ for L = 70 becomes XPF/70)

# PP Drain Aqua

Design Cover stands out for the absolute elegance of its design and for the central drain. In polished or satin stainless steel AISI 316, it is available in different lengths, from 60 to 120 cm.



PP Drain Aqua - Design Cover satin stainless steel AISI 316 DIN 1.4404

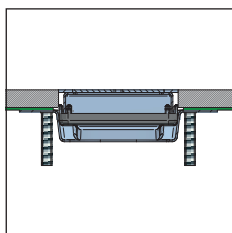



Design Cover



Design Cover

**NEW DESIGN COVER - tiles thickness from 6 to 18 mm**

ART.	finishing	L						
		60 cm	70 cm	80 cm	90 cm	100 cm	120 cm	
<b>STAINLESS STEEL</b>								
XPD/	polished stainless steel AISI 316 DIN 1.4404		22214	22215	22216	22217	22218	22219
	satin stainless steel AISI 316 DIN 1.4404		22220	22221	22222	22223	22224	22225
euro/pc			86,46	94,27	103,84	118,69	126,94	149,60

With Invisible Cover, the shower tray and the linear shower drain become as one and blend perfectly with the bathroom covering. In natural aluminium and different lengths (from 60 to 120 cm), it disappears under the tile for a completely invisible aesthetic effect.



PP Drain Aqua - Invisible Cover

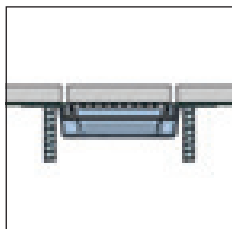

Invisible Cover



Invisible Cover

**NEW INVISIBLE COVER**

ART.	finishing	L						
		60 cm	70 cm	80 cm	90 cm	100 cm	120 cm	
<b>ALUMINIUM</b>								
XPI/	natural aluminium		22130	22131	22132	22133	22134	22135
	euro/pc		27,94	29,81	31,79	39,16	41,14	44,99

Complete the article code with L measure  
(for example XPD/ for L = 70 becomes XPD/70)

thin drain

**thindrain**

Thin Drain is a line of flush with the floor shower drains for a quick and easy installation, which allows to customize the shower with any kind of covering. Thanks to the syphon with low thickness and the height of the shower drain of just 55 mm, they are particularly suitable for refurbishments or in spaces where lightness and versatility are the main features.

**ADVANTAGES**

- Installation flush with the floor (it eliminates architectural barriers)
- Possibility of installation close to the wall
- Height of the shower drain of 55 mm (laying surface)
- Suitable for tiles with thickness up to 12 mm
- Possibility of laying tiles with thickness up to 12 mm with Tile Cover
- Shower drains with certification EN 1253-1 (minimum flow rate of 24 l/ min)
- Supports for quick installation
- Integrated waterproof membrane to reduce the risk of seepages
- Possibility of inspection of the syphon for periodic cleaning
- Filter for cleaning/hair
- Quick installation
- Drain adapter from 4 to 50 mm included



*classic cover - polished stainless steel AISI 304 - DIN 1.4301*

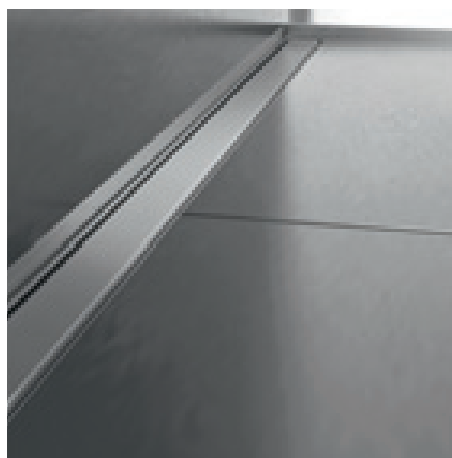

*classic cover - satin stainless steel AISI 304 - DIN 1.4301*

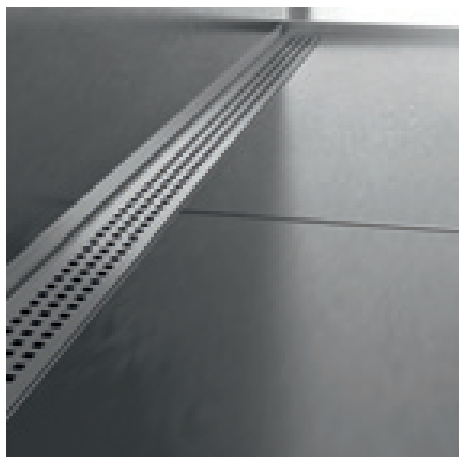

*cube cover - satin stainless steel AISI 304 - DIN 1.4301*

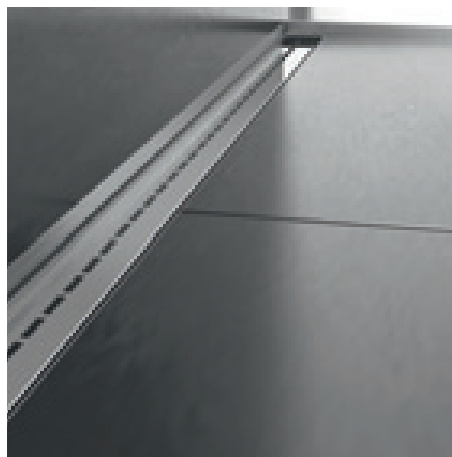

*single line cover - polished stainless steel AISI 304 - DIN 1.4301*





**THIN DRAIN - BASE** - pack 10 pcs

ART.	finishing		60 cm	70 cm	80 cm	90 cm	100 cm	120 cm
<b>STAINLESS STEEL</b>								
<b>THIN/</b>	stainless steel AISI 304 DIN 1.4301		19400	19401	19402	19403	19404	19405
	<i>euro/pc</i>		<b>290,86</b>	<b>302,81</b>	<b>318,70</b>	<b>333,33</b>	<b>350,44</b>	<b>380,96</b>



**CLASSIC COVER** - pack 10 pcs

ART.	finishing		60 cm	70 cm	80 cm	90 cm	100 cm	120 cm
<b>STAINLESS STEEL</b>								
<b>XTC/</b>	satin stainless steel AISI 304 DIN 1.4301		19410	19412	19414	19416	19418	19420
	polished stainless steel AISI 304 DIN 1.4301		19411	19413	19415	19417	19419	19421
	<i>euro/pc</i>		<b>46,78</b>	<b>51,83</b>	<b>56,86</b>	<b>62,37</b>	<b>66,56</b>	<b>76,16</b>



**CUBE COVER** - pack 10 pcs

ART.	finishing		60 cm	70 cm	80 cm	90 cm
<b>STAINLESS STEEL</b>						
<b>XTCC/</b>	satin stainless steel AISI 304 DIN 1.4301		19430	19431	19432	19433
	<i>euro/pc</i>		<b>58,77</b>	<b>63,82</b>	<b>68,85</b>	<b>74,36</b>



**SINGLE LINE COVER** - pack 10 pcs

ART.	finishing		60 cm	70 cm	80 cm	90 cm
<b>XTL/</b>	polished stainless steel AISI 304 DIN 1.4301		19440	19441	19442	19443
	<i>euro/pc</i>		<b>58,77</b>	<b>63,82</b>	<b>68,85</b>	<b>74,36</b>



**TILE COVER** - pack 10 pcs

ART.	finishing		60 cm	70 cm	80 cm	90 cm
<b>XTT/</b>	stainless steel AISI 304 DIN 1.4301		19450	19451	19452	19453
	<i>euro/pc</i>		<b>58,77</b>	<b>63,82</b>	<b>68,85</b>	<b>74,36</b>

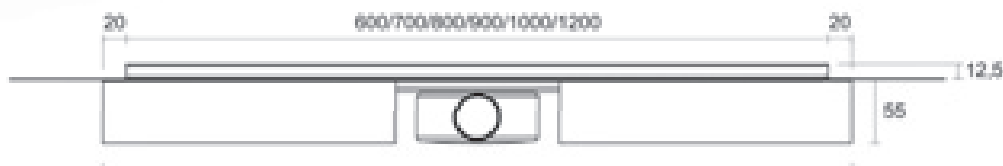
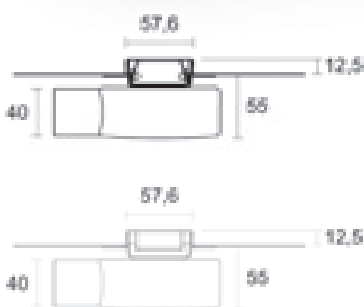
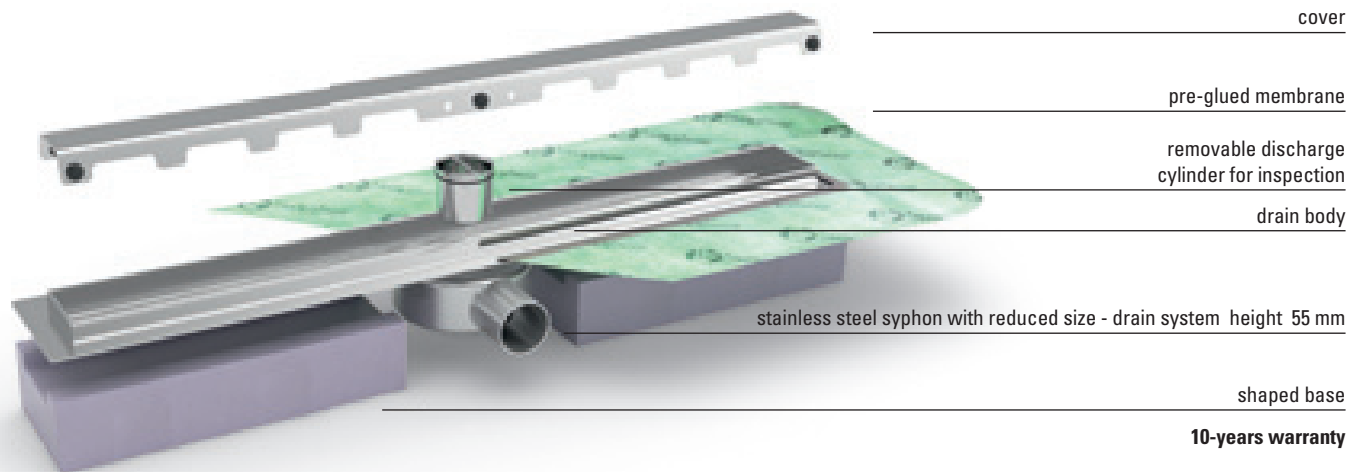

slim drain

slimdrain

Slim Drain is a line of flush with the floor shower drains for a quick and easy installation, which allows to customize the shower with any kind of covering and any tile thickness by choosing Slim Drain Invisible. Thanks to the syphon with low thickness and the height of the shower drain of just 65 mm, they are particularly suitable for refurbishments or in spaces where lightness and versatility are the main features.

ADVANTAGES

- Installation flush with the floor (it eliminates architectural barriers)
- Possibility of installation close to the wall
- Height of the shower drain of 65 mm (laying surface)
- Suitable for any tile thickness (Slim Invisible version)
- Adjustable frame (thickness 7-12,5 mm), Slim Invisible excluded.
- Shower drains with certification EN 1253-1 (minimum flow rate of 24 l/min)
- Integrated adjusting supports for an easy levelling
- Integrated waterproof membrane to reduce the risk of seepages
- Possibility of inspection of the syphon for periodic cleaning
- Filter for cleaning/hair
- Quick installation
- Drain adapter from 40 to 50 mm included

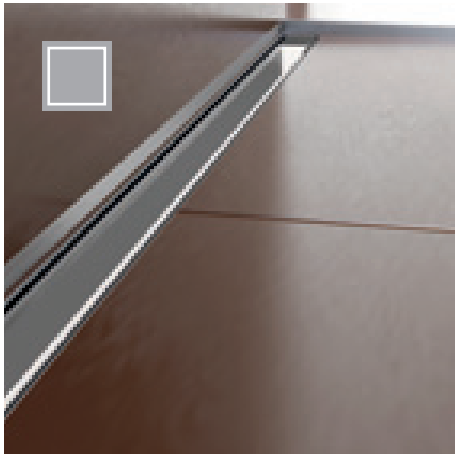

classic cover - polished stainless steel AISI 304 DIN 1.4301



classic cover - satin stainless steel AISI 304 DIN 1.4301

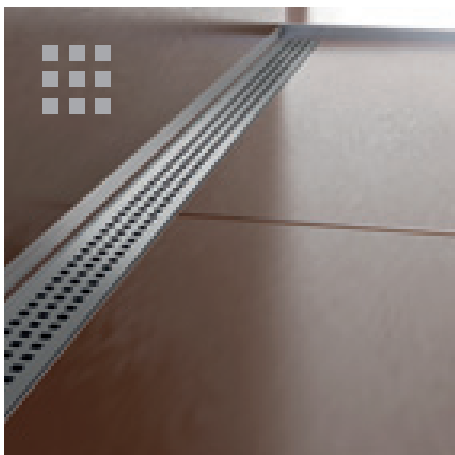

cube cover - satin stainless steel AISI 304 DIN 1.4301

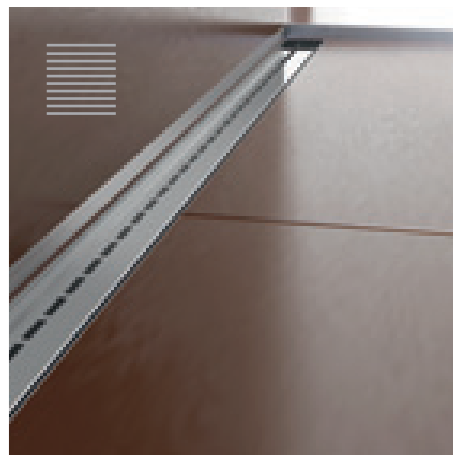

single line cover - polished stainless steel AISI 304 DIN 1.4301

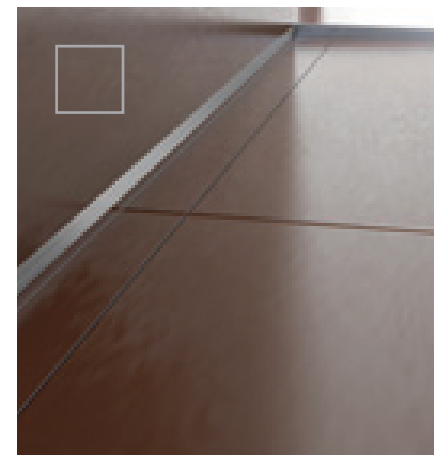



slim invisible - stainless steel AISI 304 DIN 1.4301

**SLIM DRAIN - BASE** - pack 10 pcs

ART.	finishing		60 cm	70 cm	80 cm	90 cm	100 cm	120 cm
<b>STAINLESS STEEL</b>								
<b>SLIM/</b>	stainless steel AISI 304 DIN 1.4301		19504	19506	19508	19510	19512	19514
	<i>euro/pc</i>		<b>348,00</b>	<b>361,42</b>	<b>374,87</b>	<b>389,51</b>	<b>401,71</b>	<b>428,59</b>

**CLASSIC COVER** - pack 10 pcs

ART.	finishing		60 cm	70 cm	80 cm	90 cm	100 cm	120 cm
<b>STAINLESS STEEL</b>								
<b>XSC/</b>	satin stainless steel AISI 304 DIN 1.4301		19524	19526	19528	19530	19532	19534
	polished stainless steel AISI 304 DIN 1.4301		19523	19525	19527	19529	19531	19533
	<i>euro/pc</i>		<b>31,75</b>	<b>34,19</b>	<b>37,86</b>	<b>40,30</b>	<b>43,97</b>	<b>50,07</b>

**CUBE COVER** - pack 10 pcs

ART.	finishing		60 cm	70 cm	80 cm	90 cm
<b>STAINLESS STEEL</b>						
<b>XSCC/</b>	satin stainless steel AISI 304 DIN 1.4301		19544	19546	19548	19550
	<i>euro/pc</i>		<b>31,75</b>	<b>34,19</b>	<b>37,86</b>	<b>40,30</b>

**SINGLE LINE COVER** - pack 10 pcs

ART.	finishing		60 cm	70 cm	80 cm	90 cm
<b>XSL/</b>	polished stainless steel AISI 304 DIN 1.4301		19563	19565	19567	19569
	<i>euro/pc</i>		<b>31,75</b>	<b>34,19</b>	<b>37,86</b>	<b>40,30</b>

**SLIM INVISIBLE - BASE + COVER** - pack 10 pcs

ART.	finishing		60 cm	70 cm	80 cm	90 cm
<b>SLIM-I/</b>	stainless steel AISI 304 DIN 1.4301		19505	19507	19509	19511
	<i>euro/pc</i>		<b>354,10</b>	<b>367,53</b>	<b>382,18</b>	<b>394,39</b>

Slim Invisible does not include the adjustable frame

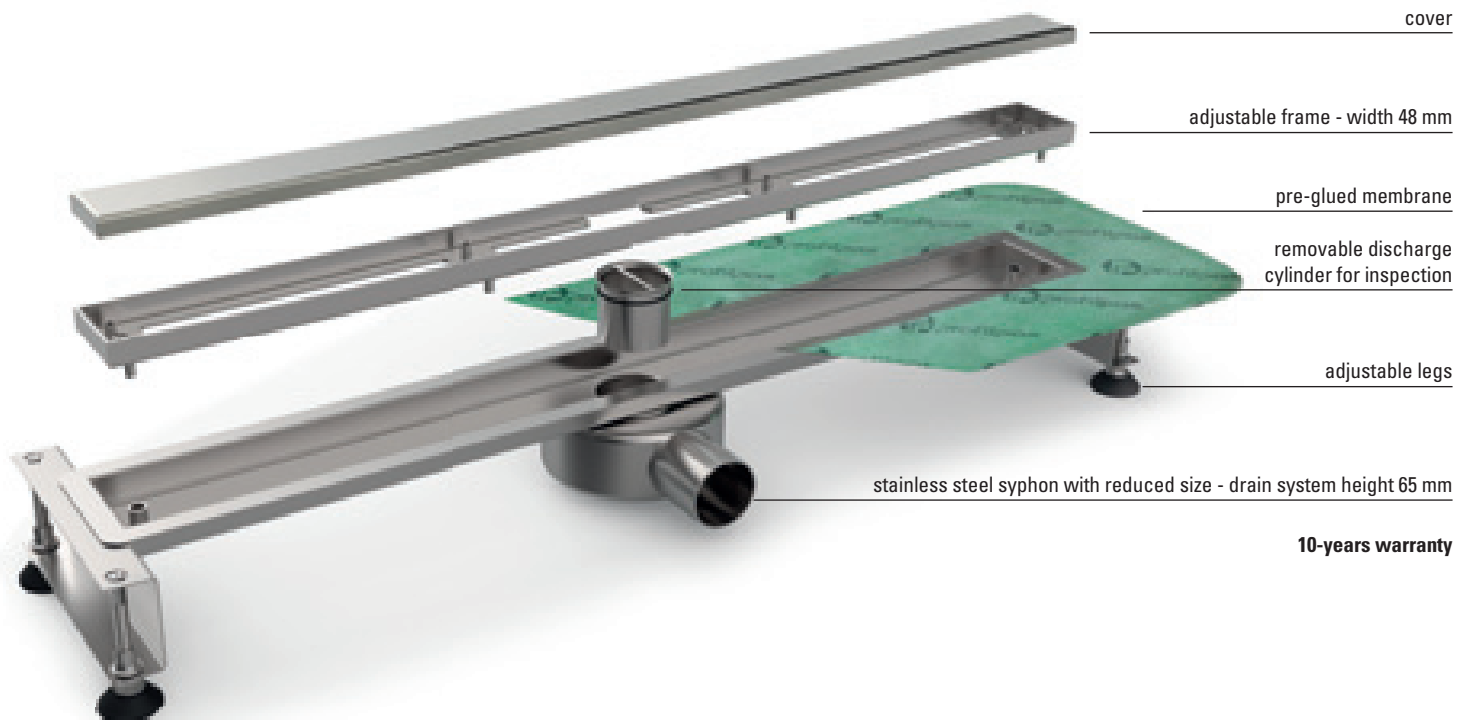
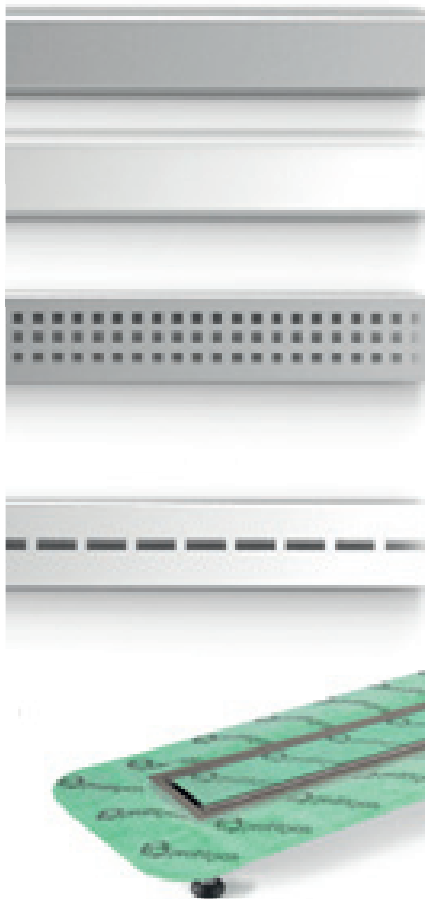

**10-years warranty**

smart drain

smartdrain

Smart Drain is a line of flush with the floor shower drains for a quick and easy installation, which allows to customize the shower with any kind of covering and any tile thickness by choosing Smart Drain Invisible. With high aesthetic level, varied sizes available and the height of the shower drain of 75 mm, they are particularly suitable for large size of tiles in every space.

ADVANTAGES

- Installation flush with the floor (it eliminates architectural barriers)
- Possibility of installation close to the wall
- Height of the shower drain of 75 mm (laying surface)
- Suitable for tiles with every tiles thickness (Smart Invisible version)
- Adjustable frame ( thickness 7-12,5 mm), excluded Smart Invisible.
- Orientable siphoned body.
- Shower drains with certification EN 1253-1 (minimum flow rate of 24 l/min)
- Integrated regular supports for a simple set - aside at the same level.
- Integrated waterproof membrane to reduce the risk of seepages
- Suitable Inox stain steel AISI 316 - DIN 14404 version
- 180° Ruotatable classic cover for tiles ( maximum thickness 10 mm )
- Possibility of inspection of the syphon for periodic cleaning
- Filter for cleaning/hair
- Quick installation



classic cover - polished stainless steel AISI 304 DIN 1.4301

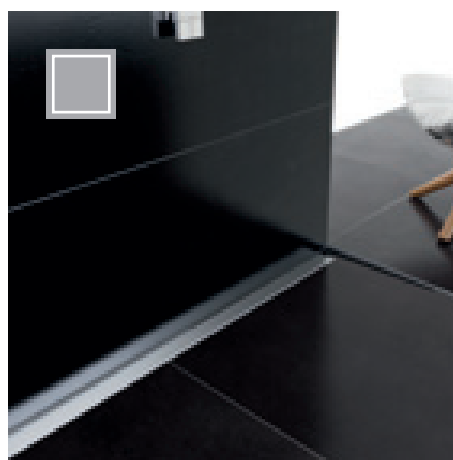

classic cover - satin stainless steel AISI 304 DIN 1.4301

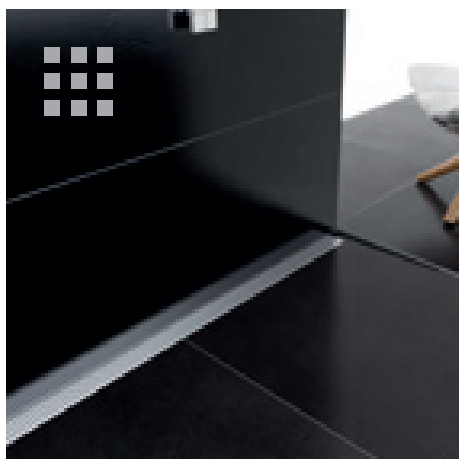

cube cover - satin stainless steel AISI 304 DIN 1.4301



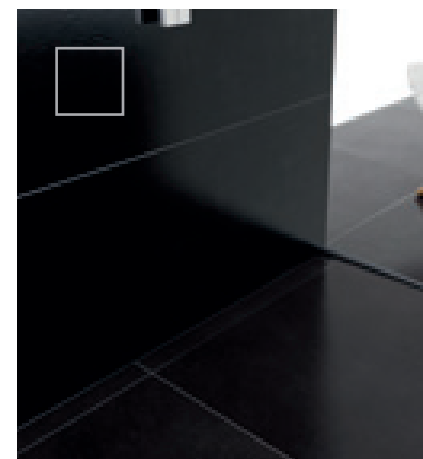

double line cover - polished stainless steel AISI 304 DIN 1.4301





smart invisible - stainless steel AISI 304 DIN 1.4301

**SMART DRAIN - BASE** - pack 10 pcs

ART.	finishing		70 cm	80 cm	90 cm	100 cm	110 cm	120 cm
<b>STAINLESS STEEL</b>								
<b>SMART/</b>	stainless steel AISI 304 DIN 1.4301		19704	19706	19708	19710	19712	19714
	<i>euro/pc</i>		<b>302,81</b>	<b>318,70</b>	<b>333,33</b>	<b>350,44</b>	<b>365,09</b>	<b>380,96</b>
<b>SMART3/</b>	stainless steel AISI 316 DIN 1.4404		19715	19716	19717	19718	-	-
	<i>euro/pc</i>		<b>332,13</b>	<b>349,23</b>	<b>367,53</b>	<b>385,85</b>	-	-

**CLASSIC COVER** - pack 10 pcs

ART.	finishing		70 cm	80 cm	90 cm	100 cm	110 cm	120 cm
<b>STAINLESS STEEL</b>								
<b>XLC/</b>	satin stainless steel AISI 304 DIN 1.4301		19724	19726	19728	19730	19732	19734
	polished stainless steel AISI 304 DIN 1.4301		19723	19725	19727	19729	19731	19733
	<i>euro/pc</i>		<b>75,73</b>	<b>79,37</b>	<b>83,03</b>	<b>86,70</b>	<b>90,35</b>	<b>94,03</b>
<b>XLC3/</b>	satin stainless steel AISI 316 DIN 1.4404		19741	19742	19743	19744	-	-
	<i>euro/pc</i>		<b>83,03</b>	<b>87,92</b>	<b>91,58</b>	<b>95,25</b>	-	-

**CUBE COVER** - pack 10 pcs

ART.	finishing		70 cm	80 cm	90 cm	100 cm	110 cm	120 cm
<b>STAINLESS STEEL</b>								
<b>XLCC/</b>	satin stainless steel AISI 304 DIN 1.4301		19764	19766	19768	19770	19772	19774
	<i>euro/pc</i>		<b>80,60</b>	<b>86,70</b>	<b>90,35</b>	<b>95,25</b>	<b>98,90</b>	<b>103,80</b>

**DOUBLE LINE COVER** - pack 10 pcs

ART.	finishing		70 cm	80 cm	90 cm	100 cm	110 cm	120 cm
<b>STAINLESS STEEL</b>								
<b>XLL/</b>	polished stainless steel AISI 304 DIN 1.4301		19783	19785	19787	19789	19791	19793
	<i>euro/pc</i>		<b>80,60</b>	<b>86,70</b>	<b>90,35</b>	<b>95,25</b>	<b>98,90</b>	<b>103,80</b>

**SMART INVISIBLE - BASE + COVER** - pack 10 pcs

ART.	finishing		70 cm	80 cm	90 cm	100 cm	110 cm	120 cm
<b>STAINLESS STEEL</b>								
<b>SMART-I/</b>	stainless steel AISI 304 DIN 1.4301		19703	19705	19707	19709	19711	19713
	<i>euro/pc</i>		<b>283,29</b>	<b>300,37</b>	<b>326,03</b>	<b>330,90</b>	<b>346,77</b>	<b>361,42</b>

Smart Invisible does not include the adjustable frame

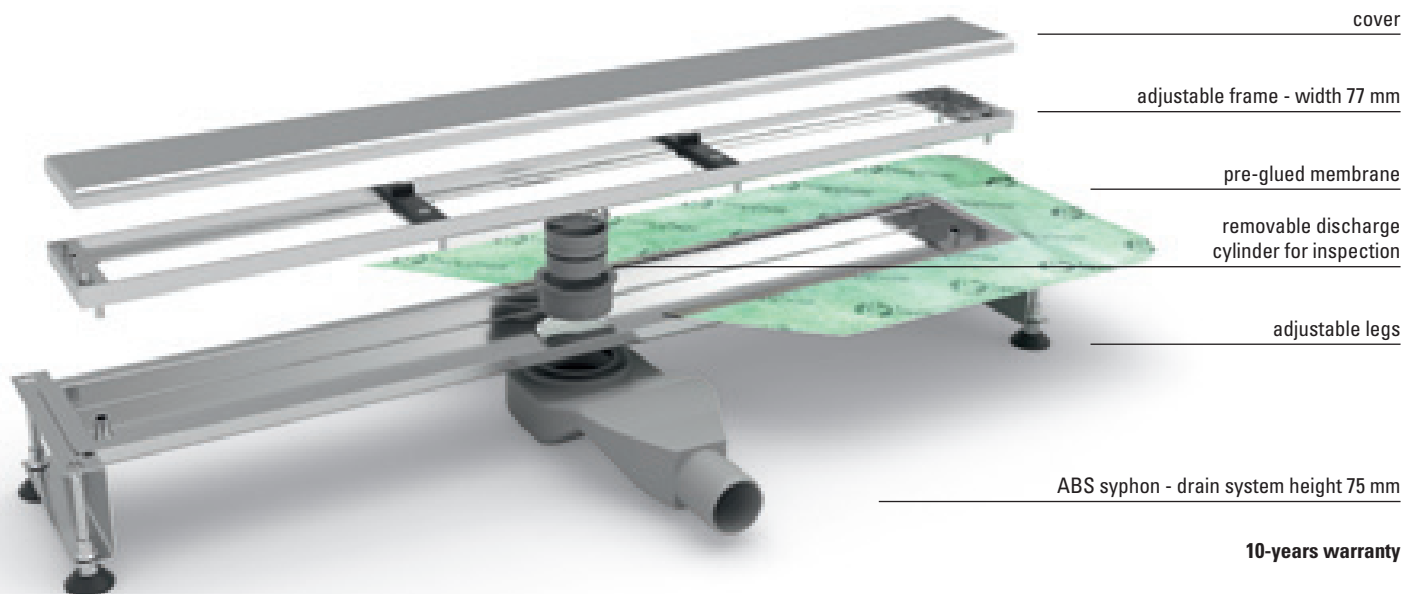
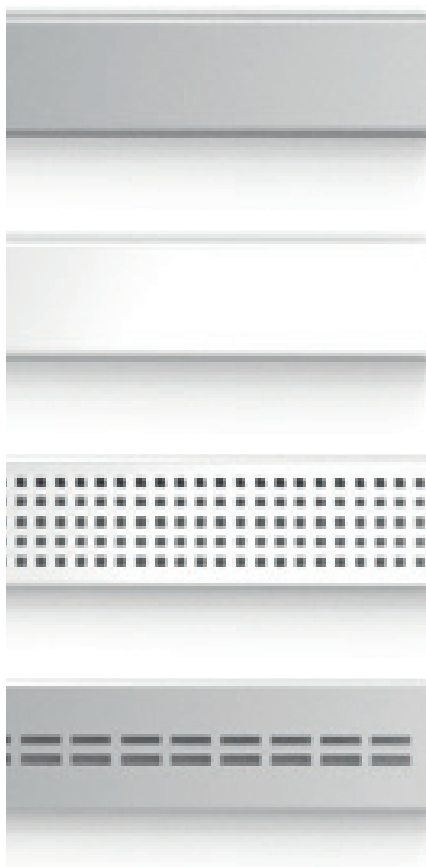

## Q drain

## q-drain

Q-Drain is a line of point drainages for flush with the floor showers which are quick and easy to install and allow to customize the shower with any kind of covering. Provided with insulating flange and with a height of 72/78 mm, they are the ideal solution for traditional showers flush with the floor.

### ADVANTAGES

- Installation flush with the floor (it eliminates architectural barriers)
- Height of the point drainage of 72/78 mm (laying surface)
- Directable syphon
- Shower drains with certification EN 1253-1 (minimum flow rate of 24 l/ min)
- Integrated waterproof membrane to reduce the risk of seepages
- Possibility of laying tiles with thickness up to 10 mm with Q Drain Tile
- Possibility of inspection of the syphon for periodic cleaning
- Filter for cleaning/hair
- Quick installation



Q Drain Cube



Q Drain Line

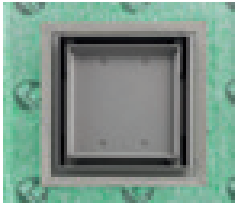
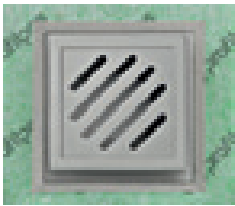
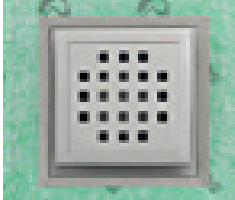
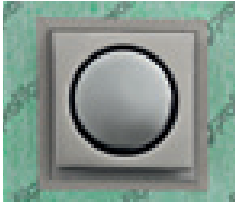

**Q DRAIN CLASSIC** - pack 10 pcs

ART.	finishing		10x10 cm
<b>STAINLESS STEEL</b>			<b>floor thickness of 12,5 mm</b>
<b>QDC/1010</b>	satin stainless steel AISI 304 DIN 1.4301		19850
	polished stainless steel AISI 304 DIN 1.4301		19851
			<b>142,74</b>
<i>euro/pc</i>			

**Q DRAIN CUBE** - pack 10 pcs

ART.	finishing		10x10 cm
<b>STAINLESS STEEL</b>			<b>floor thickness of 12,5 mm</b>
<b>QDCC/1010</b>	satin stainless steel AISI 304 DIN 1.4301		19852
	polished stainless steel AISI 304 DIN 1.4301		19853
			<b>142,74</b>
<i>euro/pc</i>			

**Q DRAIN LINE** - pack 10 pcs

ART.	finishing		10x10 cm
<b>STAINLESS STEEL</b>			<b>floor thickness of 12,5 mm</b>
<b>QDL/1010</b>	satin stainless steel AISI 304 DIN 1.4301		19854
	polished stainless steel AISI 304 DIN 1.4301		19855
			<b>142,74</b>
<i>euro/pc</i>			

**Q DRAIN TILE** - pack 10 pcs

ART.	finishing		10x10 cm
<b>STAINLESS STEEL</b>			<b>floor thickness of 10 mm</b>
<b>QDI/1010</b>	stainless steel AISI 304 DIN 1.4301		19856
			<b>142,74</b>
<i>euro/pc</i>			

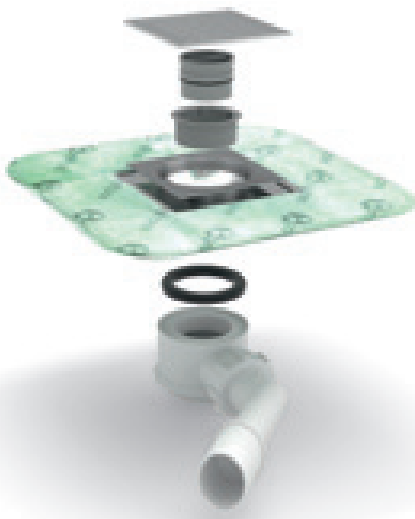

10-years warranty

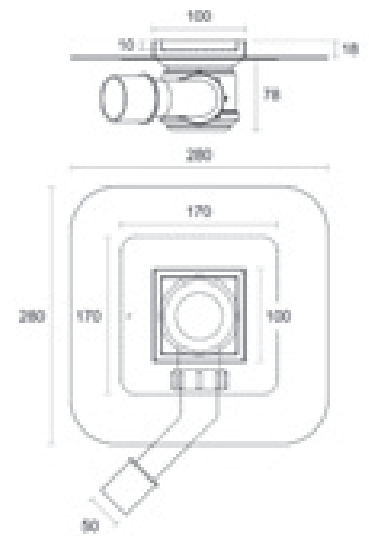
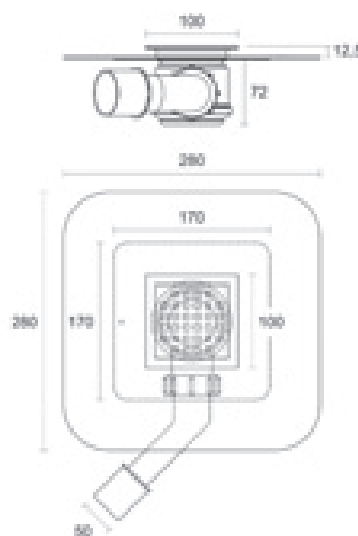

## Glass Profile

The floor-level shower is a trendy and design elements that represents a real opportunity for designing bathrooms of every dimension, highlighting their practicality and beauty. Removing the traditional shower tray, the floor-level shower can be made with the same covering of the bathroom, thus creating a uniform and elegant surface. Moreover, the absence of architectural barriers makes the access easier for children, elderly people or disabled.

Profilpas offers a series of integrated solutions for floor-level showers: a system of linear floor-level drains in stainless steel, with the possibility of also opting for the invisible version, thus creating a whole with the shower ceramic covering, which is completed by a wide range of stainless steel profiles for the insertion of glass walls and for finishing the sloping surface.





Glass Profile is a line of stainless steel profiles designed to cover the difference in height of the surface with 2% slope and create a coplanar surface with a modern and linear design. The range includes two finishes: satin stainless steel and matt black colour coated stainless steel. The versatility of these two colours become guarantee of elegance, assuring a minimalist and trendy effect.

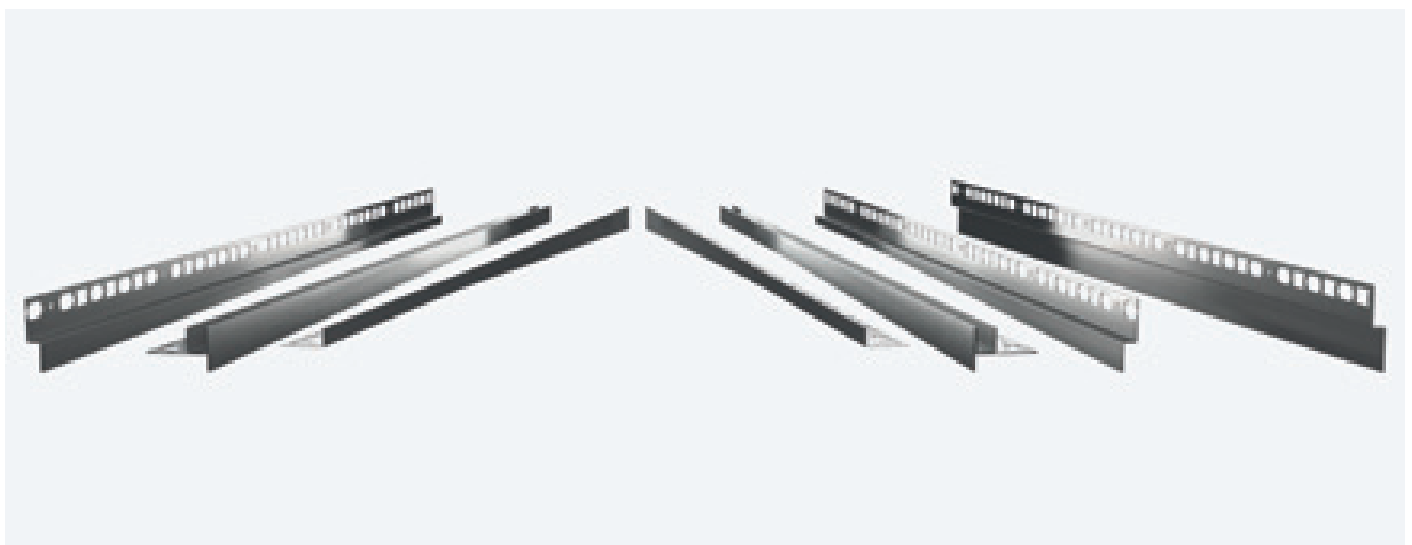

## glass profile

Glass Profile GPS1/ is a stainless steel profile for the insertion of glass walls of floor-level showers. GPS1/ is provided with a 2% slope on the shower inner side for a perfect aesthetic solution of the sloped surface.

On completion of the profile, there is GPS/6, the end cap for hiding the section of the glass wall.

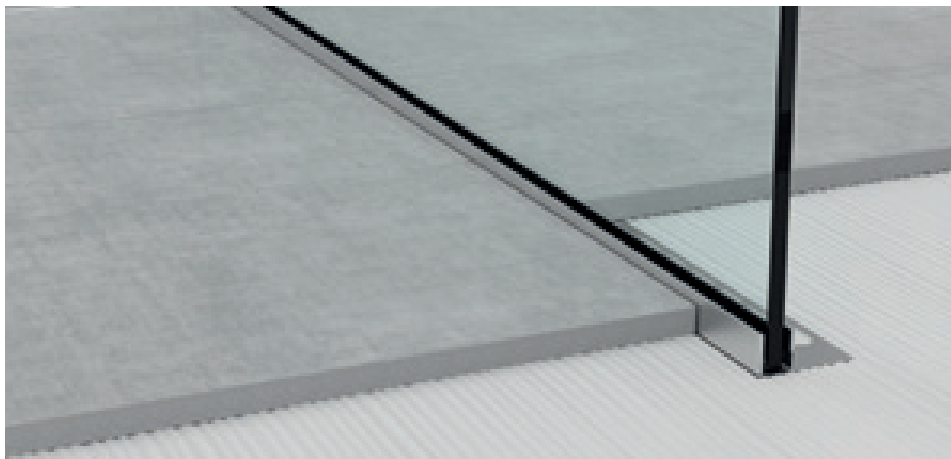

GPS1/DX/19 satin stainless steel AISI 304 DIN 1.4301

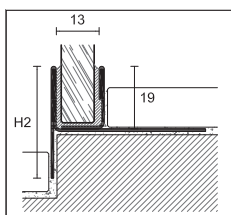

GPS1/DX/19

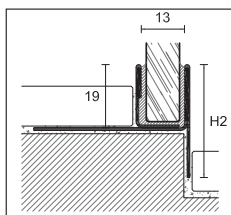

GPS1/SX/19

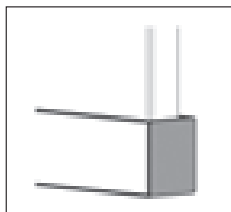

GPS/6

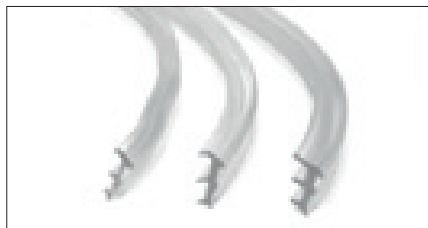

silicone glazing beads

### GLASS PROFILE

pack 5 pcs

ART.

GPS1/ /19

	DX	SX	DX	SX	DX	SX	DX	SX
length cm		98		120		148		200
H2 mm		34		37		42		60

### STAINLESS STEEL

satin stainless steel AISI 304 DIN 1.4301		31505	31507	31515	31517	31525	31527	31535	31537
<i>euro/pc</i>		<b>74,00</b>	<b>74,00</b>	<b>78,96</b>	<b>78,96</b>	<b>88,83</b>	<b>88,83</b>	<b>146,80</b>	<b>146,80</b>

**NEW**

### MATT BLACK COLOUR-COATED STAINLESS STEEL

matt black RAL 9005 colour-coated stainless steel AISI 304 DIN 1.4301		31506	31508	31516	31518	31526	31528	-	-
<i>euro/pc</i>		<b>82,31</b>	<b>82,31</b>	<b>89,15</b>	<b>89,15</b>	<b>101,39</b>	<b>101,39</b>	-	-

individually packed

### GLASS PROFILE - END CAP FOR GPS1//19

pack 5 pcs

ART.

GPS/6

### STAINLESS STEEL

satin stainless steel AISI 304 DIN 1.4301						31564			
<i>euro/pc</i>						<b>6,93</b>			

**NEW**

### MATT BLACK COLOUR-COATED STAINLESS STEEL

matt black RAL 9005 colour-coated stainless steel AISI 304 DIN 1.4301						31566			
<i>euro/pc</i>						<b>8,69</b>			

no partial packaging

### TRANSPARENT SILICONE GLAZING BEADS

pack 5 mt

ART. measures

<b>GG/2</b>	thickness 2 mm	31590
	<i>euro/pack</i>	<b>19,39</b>
<b>GG/3</b>	thickness 3 mm	31592
	<i>euro/pack</i>	<b>20,54</b>
<b>GG/4</b>	thickness 4 mm	31594
	<i>euro/pack</i>	<b>22,45</b>

no partial packaging

Complete the article code with DX and SX (DX = RH and SX = LH) - for example GPS1//19 RH becomes GPS1/DX/19. For a single piece, see sales conditions on page 288

Glass Profile GPS2/ and GPS14/12 are two stainless steel profiles for inserting glass walls on the wall covering. GPS2/ is simple to install, is suitable for tiles of any thickness and does not require drilling. GPS/6 is the end cap to complete the profile, to hide the visible section of the glass wall. GPS14/12 can be fixed directly onto the already-laid wall covering.



GPS2/19 satin stainless steel AISI 304 DIN 1.4301

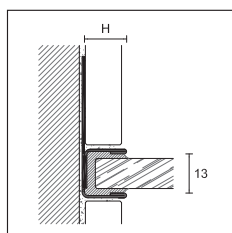

GPS2/

**GLASS PROFILE**

length = 210 cm - pack 5 pcs

ART.	finishing	NEW 10	NEW 12,5	19
------	-----------	--------	----------	----

**STAINLESS STEEL**

GPS2/	satin stainless steel AISI 304 DIN 1.4301		31541	31542	31543
	euro/pc		70,18	71,68	76,18

**NEW MATT BLACK COLOUR-COATED STAINLESS STEEL**

GPS2/	matt black RAL 9005 colour-coated stainless steel AISI 304 DIN 1.4301		31546	31547	31545
	euro/pc		88,02	89,52	94,02

individually packed

**GLASS PROFILE**

length = 250 cm - pack 5 pcs

ART.	finishing	NEW 10	NEW 12,5	19
------	-----------	--------	----------	----

**STAINLESS STEEL**

GPS2/	satin stainless steel AISI 304 DIN 1.4301		31548	31549	31544
	euro/pc		87,70	89,62	95,22

individually packed

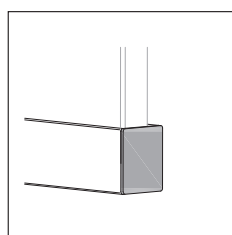

GPS/6

**GLASS PROFILE - END CAP FOR GPS2/19**

pack 5 pcs

ART.	GPS/6
------	-------

**STAINLESS STEEL**

	satin stainless steel AISI 304 DIN 1.4301		31564
	euro/pc		6,93

**NEW MATT BLACK COLOUR-COATED STAINLESS STEEL**

	matt black RAL 9005 colour-coated stainless steel AISI 304 DIN 1.4301		31566
	euro/pc		8,69

no partial packaging

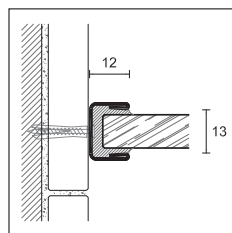

GPS14/12

**GLASS PROFILE**

pack 5 pcs

ART.	GPS14/12
------	----------

**STAINLESS STEEL**

length cm	210	250		
	satin stainless steel AISI 304 DIN 1.4301		32000	32001
	euro/pc		20,90	24,89

individually packed

Complete the article code with H measure (for example GPS2/ for H=10 becomes GPS2/10).

For a single piece, see sales conditions on page 288

## glass profile

Glass Profile GPS3/ is a stainless steel profile provided with a 2% slope on the shower inner side for a perfect aesthetic solution of the sides of the sloped surface.

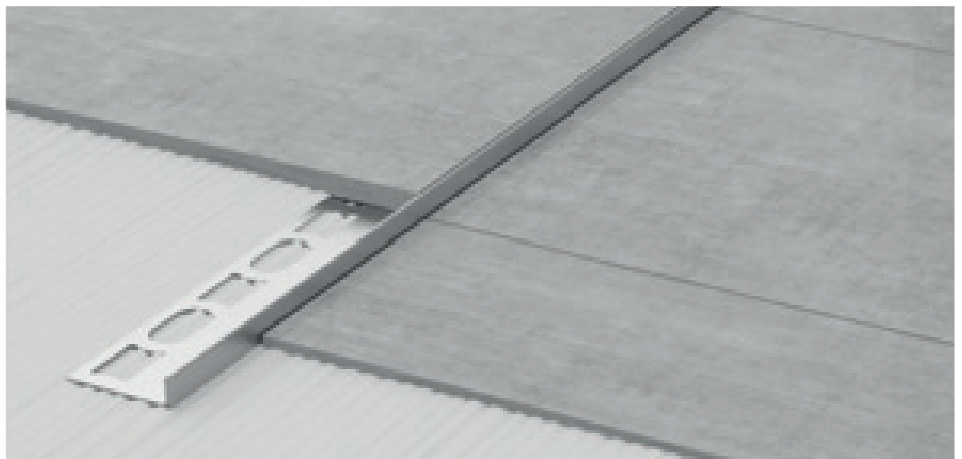

GPS3/SX/10 satin stainless steel AISI 304 DIN 1.4301

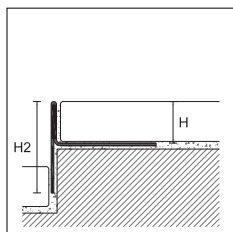

GPS3/DX/

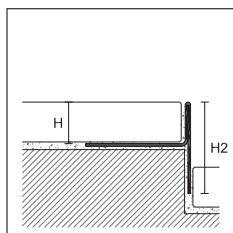

GPS3/SX/

### GLASS PROFILE

length = 98 cm - pack 5 pcs

ART.	finishing		H	H2	DX	SX
<b>STAINLESS STEEL</b>						
GPS3/ /10	satin stainless steel AISI 304 DIN 1.4301 <i>euro/pc</i>		10	25	31615	31617 <b>38,79</b>
<b>NEW</b> GPS3/ /11	satin stainless steel AISI 304 DIN 1.4301 <i>euro/pc</i>		11	26	31619	31620 <b>39,11</b>
GPS3/ /12	satin stainless steel AISI 304 DIN 1.4301 <i>euro/pc</i>		12,5	27,5	31625	31627 <b>39,47</b>
<b>NEW MATT BLACK COLOUR-COATED STAINLESS STEEL</b>						
GPS3/ /10	matt black RAL 9005 colour-coated stainless steel AISI 304 DIN 1.4301 <i>euro/pc</i>		10	25	31616	31618 <b>47,12</b>
GPS3/ /11	matt black RAL 9005 colour-coated stainless steel AISI 304 DIN 1.4301 <i>euro/pc</i>		11	26	31629	31630 <b>47,44</b>
GPS3/ /12	matt black RAL 9005 colour-coated stainless steel AISI 304 DIN 1.4301 <i>euro/pc</i>		12,5	27,5	31626	31628 <b>47,81</b>

individually packed

### GLASS PROFILE

length = 120 cm - pack 5 pcs

ART.	finishing		H	H2	DX	SX
<b>STAINLESS STEEL</b>						
GPS3/ /10	satin stainless steel AISI 304 DIN 1.4301 <i>euro/pc</i>		10	28	31645	31647 <b>41,33</b>
<b>NEW</b> GPS3/ /11	satin stainless steel AISI 304 DIN 1.4301 <i>euro/pc</i>		11	29	31649	31650 <b>41,87</b>
GPS3/ /12	satin stainless steel AISI 304 DIN 1.4301 <i>euro/pc</i>		12,5	30,5	31655	31657 <b>42,48</b>
<b>NEW MATT BLACK COLOUR-COATED STAINLESS STEEL</b>						
GPS3/ /10	matt black RAL 9005 colour-coated stainless steel AISI 304 DIN 1.4301 <i>euro/pc</i>		10	28	31646	31648 <b>51,52</b>
GPS3/ /11	matt black RAL 9005 colour-coated stainless steel AISI 304 DIN 1.4301 <i>euro/pc</i>		11	29	31652	31654 <b>52,15</b>
GPS3/ /12	matt black RAL 9005 colour-coated stainless steel AISI 304 DIN 1.4301 <i>euro/pc</i>		12,5	30,5	31656	31658 <b>52,68</b>

individually packed







GPS3/ is also available in 8 mm height on request, with a minimum order of 30 pcs.

Complete the article code with DX and SX (DX = RH and SX = LH) - for example GPS3/ /10 RH becomes GPS3/DX/10)

For a single piece, see sales conditions on page 288

**GLASS PROFILE**



length = 148 cm - pack 5 pcs

ART.	finishing		H	H2	DX	SX
<b>STAINLESS STEEL</b>						
<b>GPS3/ /10</b>	satin stainless steel AISI 304 DIN 1.4301 <i>euro/pc</i>		10	33	31675 <b>45,72</b>	31677 <b>45,72</b>
<b>NEW GPS3/ /11</b>	satin stainless steel AISI 304 DIN 1.4301 <i>euro/pc</i>		11	34	31679 <b>46,32</b>	31680 <b>46,32</b>
<b>GPS3/ /12</b>	satin stainless steel AISI 304 DIN 1.4301 <i>euro/pc</i>		12,5	35,5	31685 <b>46,87</b>	31687 <b>46,87</b>
<b>NEW MATT BLACK COLOUR-COATED STAINLESS STEEL</b>						
<b>GPS3/ /10</b>	matt black RAL 9005 colour-coated stainless steel AISI 304 DIN 1.4301 <i>euro/pc</i>		10	33	31676 <b>58,19</b>	31678 <b>58,19</b>
<b>GPS3/ /11</b>	matt black RAL 9005 colour-coated stainless steel AISI 304 DIN 1.4301 <i>euro/pc</i>		11	34	31682 <b>58,83</b>	31684 <b>58,83</b>
<b>GPS3/ /12</b>	matt black RAL 9005 colour-coated stainless steel AISI 304 DIN 1.4301 <i>euro/pc</i>		12,5	35,5	31686 <b>59,47</b>	31688 <b>59,47</b>

individually packed

**GLASS PROFILE**

length = 200 cm - pack 5 pcs

ART.	finishing		H	H2	DX	SX
<b>STAINLESS STEEL</b>						
<b>GPS3/ /10</b>	satin stainless steel AISI 304 DIN 1.4301 <i>euro/pc</i>		10	51	31694 <b>68,92</b>	31695 <b>68,92</b>
<b>GPS3/ /12</b>	satin stainless steel AISI 304 DIN 1.4301 <i>euro/pc</i>		12,5	53,5	31698 <b>70,89</b>	31699 <b>70,89</b>

individually packed



## glass profile

Glass Profile GPS4/ is a stainless steel profile provided with a 2% slope on the shower inner side. It connects the sloped floor and the covering perfectly, thus avoiding the oblique cut of the tiles.



GPS4/DX/10 matt black RAL 9005 colour-coated stainless steel AISI 304 DIN 1.4301

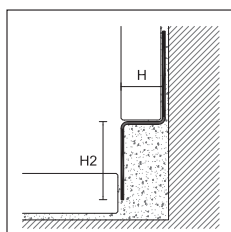

GPS4/DX/

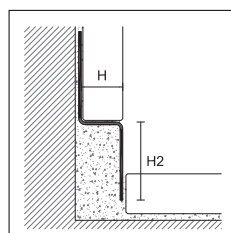

GPS4/SX/

### GLASS PROFILE

length = 98 cm - pack 5 pcs

ART.	finishing	H	H2	DX	SX
<b>STAINLESS STEEL</b>					
<b>GPS4/ /10</b>	satin stainless steel AISI 304 DIN 1.4301	10	23	31715	31717
	<i>euro/pc</i>			<b>38,21</b>	<b>38,21</b>
<b>NEW GPS4/ /11</b>	satin stainless steel AISI 304 DIN 1.4301	11	23	31716	31718
	<i>euro/pc</i>			<b>38,48</b>	<b>38,48</b>
<b>GPS4/ /12</b>	satin stainless steel AISI 304 DIN 1.4301	12,5	23	31725	31727
	<i>euro/pc</i>			<b>38,63</b>	<b>38,63</b>

### **NEW** MATT BLACK COLOUR-COATED STAINLESS STEEL

<b>GPS4/ /10</b>	matt black RAL 9005 colour-coated stainless steel AISI 304 DIN 1.4301	10	23	31719	31720
	<i>euro/pc</i>			<b>46,53</b>	<b>46,53</b>
<b>GPS4/ /11</b>	matt black RAL 9005 colour-coated stainless steel AISI 304 DIN 1.4301	11	23	31722	31724
	<i>euro/pc</i>			<b>46,80</b>	<b>46,80</b>
<b>GPS4/ /12</b>	matt black RAL 9005 colour-coated stainless steel AISI 304 DIN 1.4301	12,5	23	31726	31728
	<i>euro/pc</i>			<b>46,95</b>	<b>46,95</b>

individually packed

### GLASS PROFILE

length = 120 cm - pack 5 pcs

ART.	finishing	H	H2	DX	SX
<b>STAINLESS STEEL</b>					
<b>GPS4/ /10</b>	satin stainless steel AISI 304 DIN 1.4301	10	26	31745	31747
	<i>euro/pc</i>			<b>40,77</b>	<b>40,77</b>
<b>NEW GPS4/ /11</b>	satin stainless steel AISI 304 DIN 1.4301	11	26	31746	31748
	<i>euro/pc</i>			<b>41,02</b>	<b>41,02</b>
<b>GPS4/ /12</b>	satin stainless steel AISI 304 DIN 1.4301	12,5	26	31755	31757
	<i>euro/pc</i>			<b>41,19</b>	<b>41,19</b>

GPS4/ is also available in 8 mm height on request, with a minimum order of 30 pcs.

Completare codice articolo con DX e SX (for example GPS4/ /8 DX becomes GPS4/DX/8)

For a single piece, see sales conditions on page 288

**NEW MATT BLACK COLOUR-COATED STAINLESS STEEL**

<b>GPS4/ /10</b>	matt black RAL 9005 colour-coated stainless steel AISI 304 DIN 1.4301	■	10	26	31749	31750
	<i>euro/pc</i>				<b>50,94</b>	<b>50,94</b>
<b>GPS4/ /11</b>	matt black RAL 9005 colour-coated stainless steel AISI 304 DIN 1.4301	■	11	26	31752	31754
	<i>euro/pc</i>				<b>51,20</b>	<b>51,20</b>
<b>GPS4/ /12</b>	matt black RAL 9005 colour-coated stainless steel AISI 304 DIN 1.4301	■	12,5	26	31756	31758
	<i>euro/pc</i>				<b>51,37</b>	<b>51,37</b>

individually packed

**GLASS PROFILE**

length = 148 cm - pack 5 pcs

ART.	finishing		H	H2	DX	SX
<b>STAINLESS STEEL</b>						
<b>GPS4/ /10</b>	satin stainless steel AISI 304 DIN 1.4301	▧	10	31	31775	31777
	<i>euro/pc</i>				<b>44,90</b>	<b>44,90</b>
<b>NEW GPS4/ /11</b>	satin stainless steel AISI 304 DIN 1.4301	▧	11	31	31776	31778
	<i>euro/pc</i>				<b>45,16</b>	<b>45,16</b>
<b>GPS4/ /12</b>	satin stainless steel AISI 304 DIN 1.4301	▧	12,5	31	31785	31787
	<i>euro/pc</i>				<b>45,48</b>	<b>45,48</b>

**NEW MATT BLACK COLOUR-COATED STAINLESS STEEL**

<b>GPS4/ /10</b>	matt black RAL 9005 colour-coated stainless steel AISI 304 DIN 1.4301	■	10	31	31779	31780
	<i>euro/pc</i>				<b>57,46</b>	<b>57,46</b>
<b>GPS4/ /11</b>	matt black RAL 9005 colour-coated stainless steel AISI 304 DIN 1.4301	■	11	31	31782	31784
	<i>euro/pc</i>				<b>57,72</b>	<b>57,72</b>
<b>GPS4/ /12</b>	matt black RAL 9005 colour-coated stainless steel AISI 304 DIN 1.4301	■	12,5	31	31786	31800
	<i>euro/pc</i>				<b>58,05</b>	<b>58,05</b>

individually packed

**GLASS PROFILE**

length = 200 cm - pack 5 pcs

ART.	finishing		H	H2	DX	SX
<b>STAINLESS STEEL</b>						
<b>GPS4/ /10</b>	satin stainless steel AISI 304 DIN 1.4301	▧	10	49	31794	31795
	<i>euro/pc</i>				<b>75,30</b>	<b>75,30</b>
<b>GPS4/ /12</b>	satin stainless steel AISI 304 DIN 1.4301	▧	12,5	49	31798	31799
	<i>euro/pc</i>				<b>76,12</b>	<b>76,12</b>

individually packed

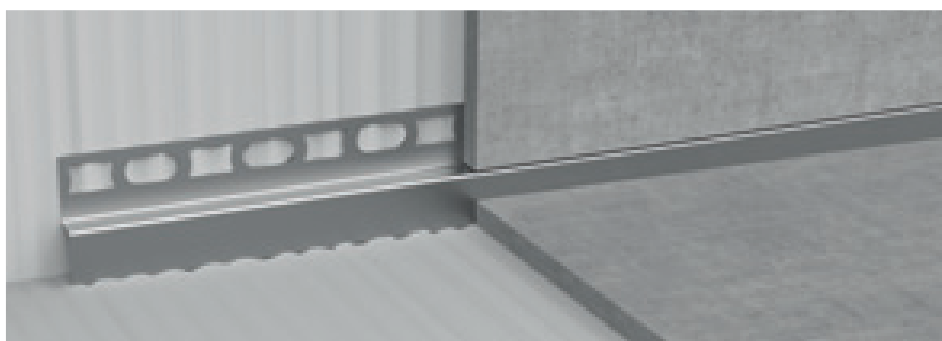

GPS4/SX/10 satin stainless steel AISI 304 DIN 1.4301

## glass profile

Glass Profile GPS5/ is a stainless steel profile to be positioned on the wall covering, above the shower drain with sloped surface, in order to avoid the cut of the tiles.

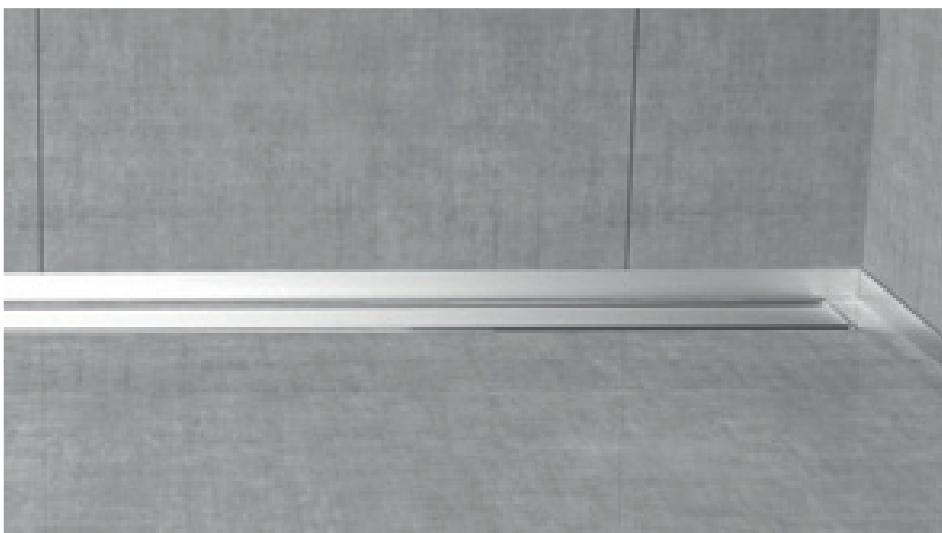



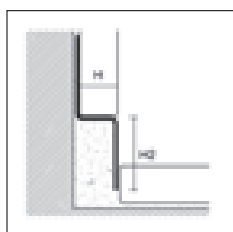



GPS5/ satin stainless steel AISI 304 DIN 1.4301



GPS5/

### GLASS PROFILE

length = 125 cm - pack 5 pcs

ART.	finishing		H		H2	
<b>STAINLESS STEEL</b>						
				<b>23</b>	<b>33</b>	<b>45</b>
GPS5/10/	satin stainless steel AISI 304 DIN 1.4301		10	31551	31553	31559
	<i>euro/pc</i>			<b>30,82</b>	<b>31,38</b>	<b>32,81</b>
<b>NEW</b> GPS5/11/	satin stainless steel AISI 304 DIN 1.4301		11	31563	31572	-
	<i>euro/pc</i>			<b>30,95</b>	<b>31,54</b>	-
GPS5/12/	satin stainless steel AISI 304 DIN 1.4301		12,5	31555	31557	31561
	<i>euro/pc</i>			<b>31,10</b>	<b>31,65</b>	<b>33,08</b>
<b>NEW MATT BLACK COLOUR-COATED STAINLESS STEEL</b>						
GPS5/10/	matt black RAL 9005 colour-coated stainless steel AISI 304 DIN 1.4301		10	31567	31568	-
	<i>euro/pc</i>			<b>41,42</b>	<b>41,98</b>	-
GPS5/11/	matt black RAL 9005 colour-coated stainless steel AISI 304 DIN 1.4301		11	31570	31571	-
	<i>euro/pc</i>			<b>41,55</b>	<b>42,14</b>	-
GPS5/12/	matt black RAL 9005 colour-coated stainless steel AISI 304 DIN 1.4301		12,5	31573	31574	-
	<i>euro/pc</i>			<b>41,70</b>	<b>42,25</b>	-

individually packed

GPS5/ is also available in 8 mm height on request, with a minimum order of 30 pcs.

Complete the article code with H2 measure (for example GPS5/10/ for H2 = 23 becomes GPS5/10/23).

For a single piece, see sales conditions on page 288



GPS5/ matt black RAL 9005 colour-coated stainless steel AISI 304 DIN 1.4301



GU/ and TGU/ are anodised aluminium profiles suitable for the insertion of glass walls on the floor and on the wall of floor-level showers.

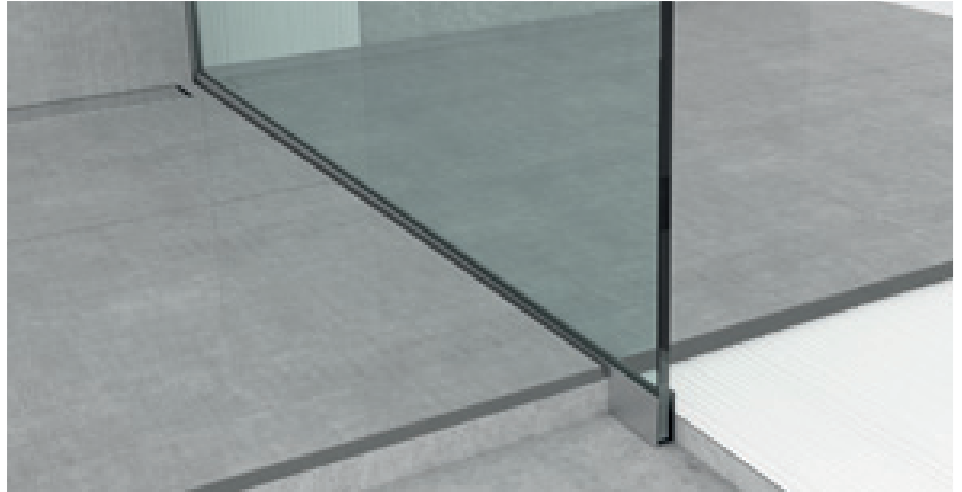

GU/40/12 + TGU/12 silver anodised aluminium

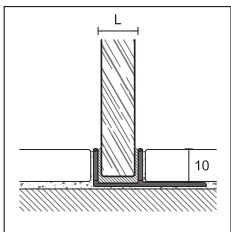

TGU/

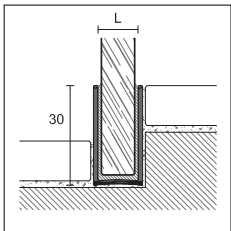

GU/30/

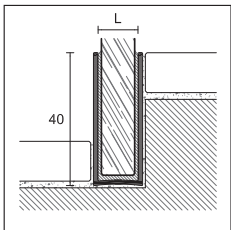

GU/40/

**GLASS PROFILE**

length = 270 cm - pack 10 pcs

		L	
ART.	finishing	12	14
<b>ALUMINIUM</b>			
TGU/	silver anodised	67760	67762
	euro/m	6,48	6,48

individually packed

**GLASS PROFILE**

length = 270 cm - pack 10 pcs

		L	
ART.	finishing	12	14
<b>ALUMINIUM</b>			
GU/30/	silver anodised	67770	67772
	euro/m	7,00	7,00
GU/40/	silver anodised	67780	67782
	euro/m	8,27	8,27

individually packed

Complete the article code with L measure  
(for example GU/30/ per L = 12 becomes  
GU/30/12)

For a single piece, see sales conditions on page 288

## wpstop

WPstop is a waterproof membrane in polyethylene with a textile in polypropylene in both sides in order to facilitate the grip of the adhesive, thus ensuring a high adhesion to the support. It is particularly suitable for the waterproofing of floors and tiled walls of bathrooms.

PAIG/ are special pre-formed pieces for waterproofing the internal corners of floor-level showers using Glass Profile GPS1 and GPS3.

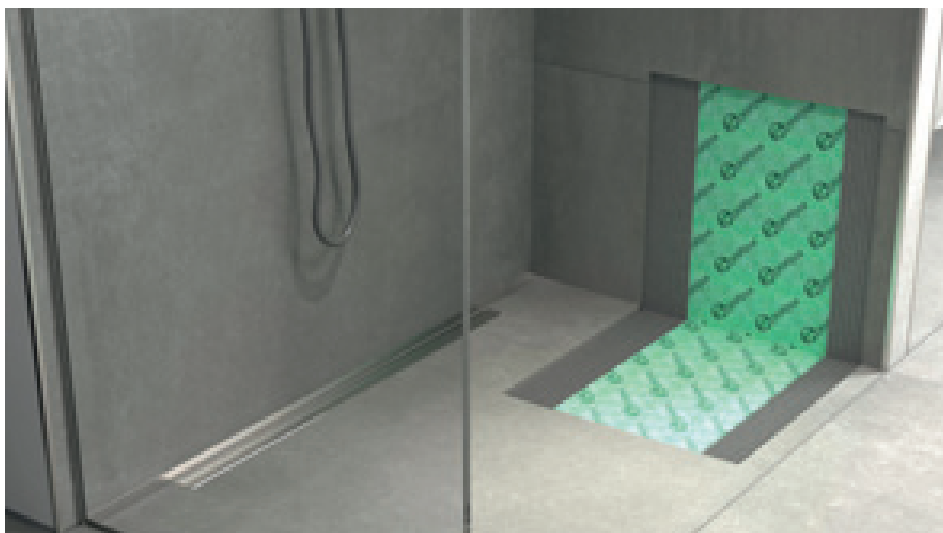

sistema Wpstop



rolls



stripes

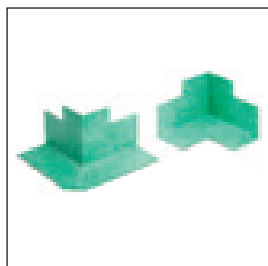

corners

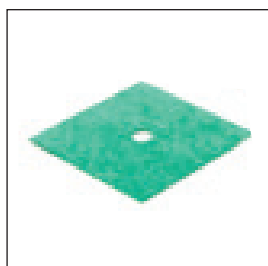

colar

### WPSTOP

#### ART. measures

<b>PR30</b>	roll 1 m height 30 mt length - pack 1 roll	19900
	<i>euro/m</i>	<b>10,37</b>
<b>PR5</b>	roll 1 m height 5 mt length - pack 6 rolls	19902
	<i>euro/m</i>	<b>12,16</b>
<b>PB30</b>	stripe 14 cm height 30 mt length - pack 1 roll	19910
	<i>euro/m</i>	<b>3,18</b>
<b>PB5</b>	stripe 14 cm height 5 mt length - pack 6 rolls	19912
	<i>euro/m</i>	<b>4,12</b>
<b>PAE</b>	outside corner - pack 10 pcs	19920
	<i>euro/pc</i>	<b>7,65</b>
<b>PAI</b>	inside corner - pack 10 pcs	19922
	<i>euro/pc</i>	<b>7,65</b>
<b>PF12</b>	colar cm 12x12 - pack 10 pcs	19930
	<i>euro/pc</i>	<b>5,95</b>

no partial packaging

#### INSTRUCTIONS

Store in a cool and dry place, avoiding direct exposure to sunlight and heat sources.

Please refer to the technical data sheet before the installation. For special installations, please contact our technical department.

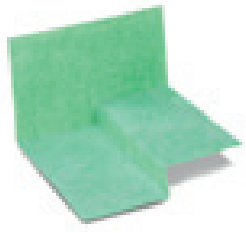

PAIG/DX/

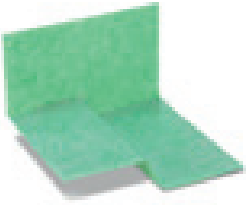

PAIG/SX/

**NEW WPSTOP - CORNERS FOR GLASS PROFILE GPS1 AND GPS3**

ART.	measures	RX	LH
<b>PAIG//15</b>	inside corner - pack 10 pcs	19931	19932
	<i>euro/pc (euro/pack.)</i>	<b>14,31 (143,10)</b>	<b>14,31 (143,10)</b>
<b>PAIG//20</b>	inside corner - pack 10 pcs	19933	19934
	<i>euro/pc (euro/pack.)</i>	<b>14,31 (143,10)</b>	<b>14,31 (143,10)</b>
<b>PAIG//28</b>	inside corner - pack 10 pcs	19935	19936
	<i>euro/pc (euro/pack.)</i>	<b>14,31 (143,10)</b>	<b>14,31 (143,10)</b>
<b>PAIG//38</b>	inside corner - pack 10 pcs	19937	19938
	<i>euro/pc (euro/pack.)</i>	<b>14,31 (143,10)</b>	<b>14,31 (143,10)</b>

no partial packaging

**INSTRUCTIONS**

Store in a cool and dry place, avoiding direct exposure to sunlight and heat sources.

Please refer to the technical data sheet before the installation. For special installations, please contact our technical department.

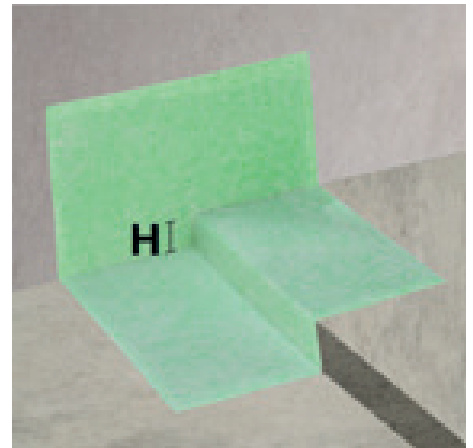
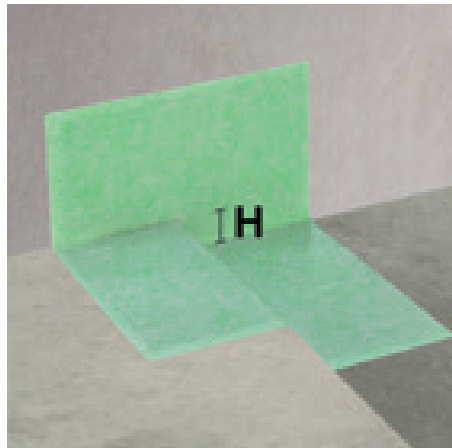

Complete the article code with DX and SX (DX = RH and SX = LH) - for example PAIG//15 RH becomes PAIG/DX/15.

For a single piece, see sales conditions on page 288

## glass profile

Sanibord BP/22 and BP/25 are technical profiles in coextruded PVC to be installed between the covering and the bath tub or shower tray during the laying. These profiles allow to avoid the use of silicone and, besides the aesthetic advantages, guarantee a high hygienic level over time.



BP/22



BP/25

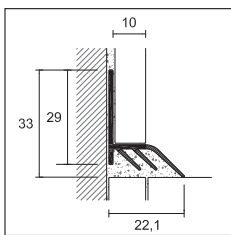

BP/22

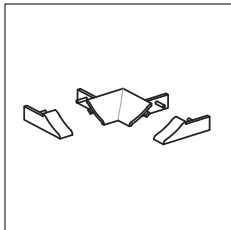

BPT/22

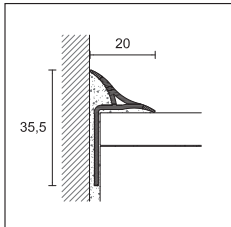

BP/25

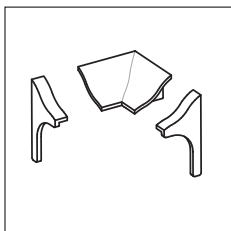

BPT/25

### SANIBORD

length = 270 cm - pack 20 pcs

ART. finishing

CO-EXTRUDED PVC

<b>BP/22</b>	anti-mould white	<input type="checkbox"/>	95520
	<i>euro/m</i>		<b>6,73</b>

no partial packaging

### INSIDE CORNER AND RIGHT/LEFT END CAPS FOR BP/22

pack 6 blister

ART. finishing

POLYPROPYLENE

<b>BPT/22</b>	white	<input type="checkbox"/>	95530
	<i>euro/blister</i>		<b>4,53</b>

no partial packaging

### SANIBORD

length = 270 cm - pack 20 pcs

ART. finishing

CO-EXTRUDED PVC

<b>BP/25</b>	anti-mould white	<input type="checkbox"/>	95540
	<i>euro/m</i>		<b>6,73</b>

no partial packaging

### INSIDE CORNER AND RIGHT/LEFT END CAPS FOR BP/25

pack 6 blister

ART. finishing

POLYPROPYLENE

<b>BPT/25</b>	white	<input type="checkbox"/>	95545
	<i>euro/blister</i>		<b>4,53</b>

no partial packaging

### KIT: 1 PC OF 180 CM + 2 PCS OF 90 CM + 2 INSIDE CORNERS AND RIGHT/LEFT END CAPS

pack 10 pcs

ART. finishing

CO-EXTRUDED PVC

<b>BPK/25</b>	anti-mould white	<input type="checkbox"/>	95494
	<i>euro/kit</i>		<b>32,43</b>

individually packed - no partial packaging

Sanibord BH/20 and BP/20 are technical profiles in colour-coated aluminium and coextruded PVC to be installed between the covering and the bath tub or the shower tray. These profiles allow the use of silicone and, besides the aesthetic advantages, guarantee a high hygienic level over time.

BH/20 in colour-coated aluminium is provided with the certified antibacterial technology (according to the internationally recognized laboratory test JIS Z 2801:2000) which allows to reduce the presence of the most dangerous bacteria up to 99%.



BP/20 anti-mould white co-extruded PVC

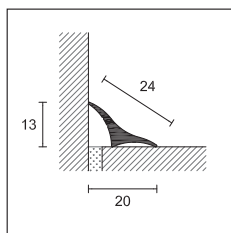

BH/20

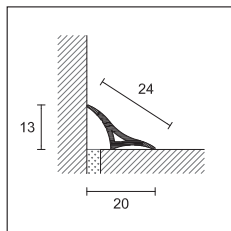

BP/20

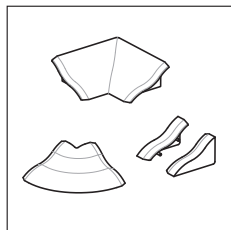

BPT/20

**SANIBORD**

length = 270 cm - pack 20 pcs

**ART.** finishing

**ANTIBACTERIAL COLOUR-COATED ALUMINIUM**

<b>BH/20</b>	colour-coated white antibacterial RAL 9003	<input type="checkbox"/>	95459
	<i>euro/m</i>		<b>8,20</b>
<b>BH/20/A adhesive</b>	colour-coated white antibacterial RAL 9003	<input type="checkbox"/>	95460
	<i>euro/m</i>		<b>9,27</b>

**SANIBORD**

length = 270 cm - pack 20 pcs

**ART.** finishing

**CO-EXTRUDED PVC**

<b>BP/20</b>	anti-mould white	<input type="checkbox"/>	95490
	<i>euro/m</i>		<b>4,45</b>
<b>BP/20/A adhesive</b>	anti-mould white	<input type="checkbox"/>	95470
	<i>euro/m</i>		<b>5,86</b>

no partial packaging

**INSIDE CORNER, OUTSIDE CORNER, RIGHT/LEFT END CAPS FOR BH/20 AND BP/20**

pack 6 blister

**ART.** finishing

**POLYPROPYLENE**

<b>BPT/20</b>	white	<input type="checkbox"/>	95480
	<i>euro/blister</i>		<b>6,29</b>

no partial packaging

**KIT: 1 PC OF 180 CM + 2 PCS OF 90 CM + 2 INSIDE CORNERS AND RIGHT/LEFT END CAPS**

pack 10 pcs

**ART.** finishing

**CO-EXTRUDED PVC**

<b>BPK/20</b>	anti-mould white	<input type="checkbox"/>	95544
	<i>euro/kit</i>		<b>27,26</b>

individually packed excepted BP20 - no partial packaging

**MS POLYMER-BASED ADHESIVE FOR SKIRTING BOARDS**

quantity 290 ml - pack 24 pcs

**ART.**

<b>PP/96</b>		<input type="checkbox"/>	78301
	<i>euro/pc</i>		<b>18,81</b>





## profiles for floors of same height

The range of profiles is designed to combine different materials with elegance and simplicity. The coupling of different materials thus becomes interior style and not visual limit.

# profiles for floors of same height

## cerfix® proangle

Proangle is a line of profiles to finish, protect and decorate floors of same level in ceramic, marble, granite, wood or other material. It is also ideal as separation and decoration joint between floors made of different materials, as finishing and protection element for the edges of steps, platforms and worktops and as perimeter profile for the shaping of doormats. Proangle B in natural aluminium is particularly suitable where it is necessary to proceed to polishing, even deep, of marble, resin and wood surfaces.



AI/10 stainless steel AISI 304 DIN 1.4301

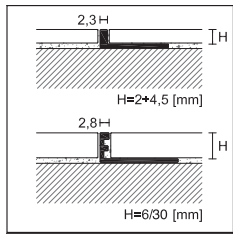

ZG/  
ZA/  
ZN/  
ZK/

PPDESIGN

### PROANGLE

length = 270 cm - pack 20 pcs

		H				
ART.	finishing	2	2,5	3	4,5	6
<b>ALUMINIUM</b>						
ZG/	natural aluminium	90207	90206	90208	90210	88159
	euro/m	2,08	2,08	2,08	2,23	2,29
ZA/	silver anodised	90336	90337	90338	90340	88204
	euro/m	2,95	2,95	2,95	3,08	3,15
<b>BRASS</b>						
ZN/	natural brass	-	-	90078	90080	88024
	euro/m	-	-	7,37	7,53	7,76
ZK/	chromium plated	-	-	-	90081	88114
	euro/m	-	-	-	16,93	17,05

individually packed - ZA/ H 10 and ZG/ H 8 - 10 - 12 are available in length of 90 cm euro/m + 0,42 art. ZN/22,5 pack 5 pcs

### PROANGLE

length = 270 cm - pack 20 pcs

		H			
ART.	finishing	3	4,5	6	8
<b>STAINLESS STEEL</b>					
AI/	stainless steel AISI 304 DIN 1.4301	91636	91638	91642	91644
	euro/m	6,98	7,11	7,44	7,69
AIS/	satin stainless steel AISI 304 - DIN 1.4301	-	91671	91673	91674
	euro/m	-	8,89	9,23	9,48
AIX/	stainless steel AISI 316 DIN 1.4404	-	-	91684	91685
	euro/m	-	-	8,76	8,96

individually packed - AI/ H 10 is available in length of 90 cm euro/m + 0,42

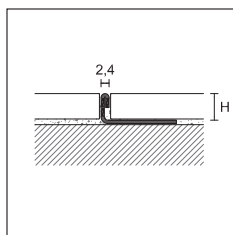

AI/  
AIS/  
AIX/

Profiles PROANGLE sandblasted stainless steel finish see page 96

Complete the article code with H measure (for example ZG/ for H=10 becomes ZG/10)

Items AIX/ in other heights, on demand for minimum 540 meters for each height

For a single piece, see sales conditions on page 288



ZG/10 natural aluminium

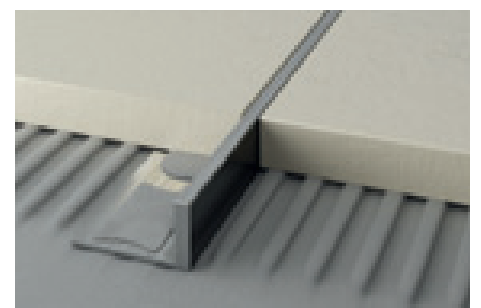

ZBG/10 natural aluminium





ZN/10 natural brass



ZK/10 chromium-plated brass

H												
8	9	10	11	12,5	14	15	17,5	20	22,5	25	27,5	30
88160	88155	88161	88156	88162	88157	88163	88164	88165	88166	88167	-	-
2,44	2,51	2,54	2,61	2,68	2,79	2,90	3,23	3,40	3,68	3,89	-	-
88205	88217	88206	88218	88207	-	88208	88209	88210	88211	88212	-	-
3,23	3,31	3,39	3,66	3,91	-	4,16	4,54	4,91	5,19	5,54	-	-
88025	-	88026	88038	88027	-	88028	88029	88030	88031	-	-	-
8,24	-	8,81	9,16	9,49	-	10,25	11,27	12,03	12,65	-	-	-
88115	-	88116	88118	88117	-	-	-	-	-	-	-	-
17,63	-	18,02	18,29	18,67	-	-	-	-	-	-	-	-

H												
9	10	11	12,5	14	15	17,5	20	22,5	25	27,5	30	
91645	91646	91647	91648	91649	91650	91652	91654	91656	91658	91660	91662	
7,89	8,05	8,23	8,37	8,58	8,84	9,26	9,60	10,14	10,78	11,20	11,61	
-	91675	91677	91676	-	91678	-	91679	-	-	-	-	
-	9,83	9,99	10,16	-	11,64	-	13,46	-	-	-	-	
-	91686	91688	91687	-	-	-	-	-	-	-	-	
-	9,45	9,94	10,41	-	-	-	-	-	-	-	-	

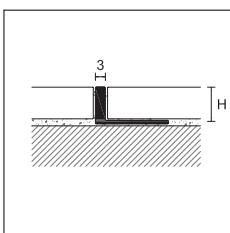

ZBG/

**PROANGLE B**

length = 270 cm - pack 20 pcs

		H					
ART.	finishing	8	10	12,5	15	20	22,5
<b>ALUMINIUM</b>							
ZBG/	natural aluminium	90010	90012	90014	90016	90018	90020
	euro/m	3,20	3,28	3,58	3,97	4,61	4,85

individually packed

Complete the article code with H measure (for example ZBG/ for H=10 becomes ZBG /10)

For a single piece, see sales conditions on page 288

# proflex line

Proangle is also available in the Flex version, specially studied for those situations where there is the need to curve the profile. Proangle Flex can be curved by hand or through the specific tool Proflex Machine.



AIF/10 stainless steel AISI 304 DIN 14301

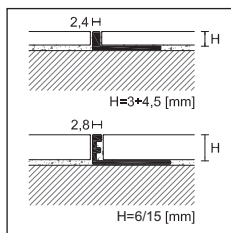

ZGF/

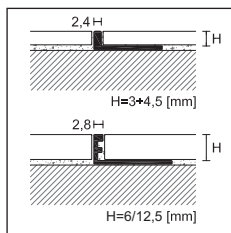

ZNF/

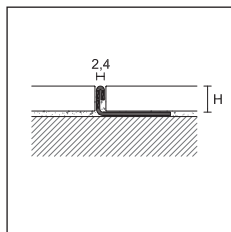

AIF/

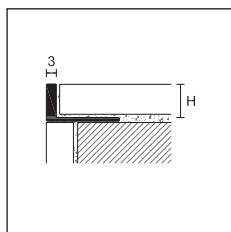

ZBGF/

**PRO FLEX LINE**

**PROANGLE FLEX**

length = 270 cm - pack 20 pcs

		H						
ART.	finishing	3	4,5	6	8	10	12,5	15
<b>ALUMINIUM</b>								
ZGF/	natural aluminium	88720	88721	88722	88723	88724	88725	88726
	euro/m	2,93	3,13	3,17	3,32	3,40	3,54	3,77

**BRASS**

ZNF/	natural brass	88701	-	88703	88704	88705	88706	-
	euro/m	8,20	-	8,56	9,04	9,51	10,26	-

length = 270 cm - pack 10 pcs

**STAINLESS STEEL**

AIF/	stainless steel AISI 304 DIN 14301	-	-	91622	91623	91624	91625	-
	euro/m	-	-	9,14	9,42	9,79	10,11	-

Proangle Flex is available in other heights on request.

**PRO FLEX LINE**

**PROANGLE FLEX**

length = 270 cm - pack 20 pcs

		H					
ART.	finishing	8	10	12,5	15	20	22,5
<b>ALUMINIUM</b>							
ZBGF/	natural aluminium	90011	90013	90015	90017	90019	90021
	euro/m	4,41	4,47	4,77	5,15	5,69	5,94

individually packed

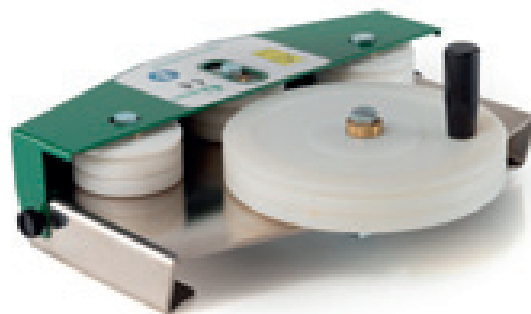

Complete the article code with H measure (for example ZGF/ for H=8 becomes ZGF/8)

For a single piece, see sales conditions on page 288

PROFLEX MACHINE - hand machine to bend proflex line profiles, see page 267

Prodecor and Prodecor DJ are two lines of profiles for finishing and protecting floors of same level in ceramic, marble, granite, wood or other materials. They are also ideal as separation and decoration joints between floors made of different materials, as perimeter profiles for the shaping of doormats or as protection and finishing of platforms and ceramic steps.

The visible thickness makes the profile an elegant separation element perfectly integrated into the floor.

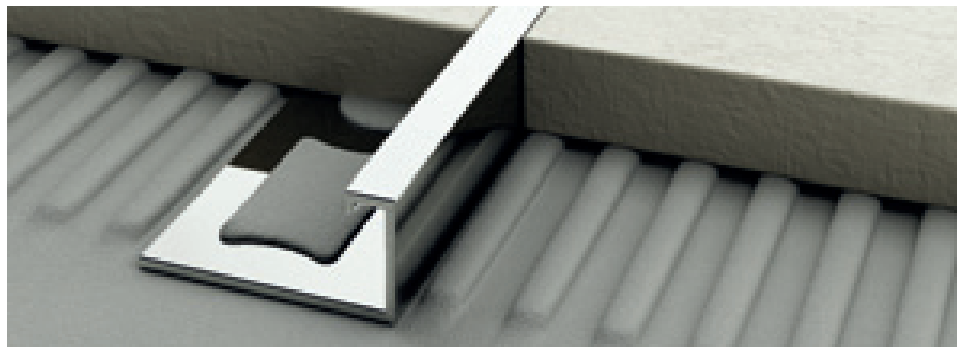

DJK/15 chromium-plated brass

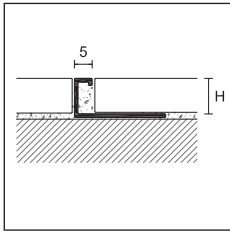

DJG/  
DJA/  
DJN/  
DJK/

PPDESIGN

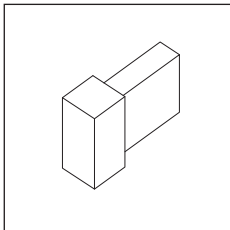

**PRODECOR DJ**

length = 270 cm - pack 20 pcs

		H				
ART.	finishing	8	10	12,5	15	20
<b>ALUMINIUM</b>						
DJG/	natural aluminium	95670	95672	95674	-	-
	euro/m	4,17	4,48	4,80	-	-
DJA/	silver anodised	95680	95682	95684	-	-
	euro/m	5,42	5,70	6,01	-	-
<b>BRASS</b>						
DJN/	natural brass	95690	95692	95694	95691	95693
	euro/m	11,40	11,82	12,35	13,16	14,69
<b>CHROMIUM-PLATED BRASS</b>						
DJK/	chromium plated	95700	95702	95704	95703	95705
	euro/m	18,87	19,31	19,86	20,69	22,24

individually packed - art. DJN/20 and DJK/20 pack 10 pcs

**OUTSIDE AND INSIDE CORNERS**

pack 5 pcs

		H				
ART.	finishing	8	10	12,5	15	20
<b>ALUMINIUM</b>						
DJG/ /EI	natural aluminium	95676	95677	95678	-	-
	euro/pc	5,93	5,93	5,93	-	-
DJA/ /EI	silver anodised	95686	95687	95688	-	-
	euro/pc	7,10	7,10	7,10	-	-
<b>BRASS</b>						
DJN/ /EI	natural brass	95696	95697	95698	95715	95716
	euro/pc	10,45	10,45	10,45	10,45	10,45
<b>CHROMIUM-PLATED BRASS</b>						
DJK/ /EI	chromium plated	95706	95707	95708	95709	95710
	euro/pc	16,15	16,15	16,15	16,15	16,15

no partial packaging

PRO FLEX LINE

**PRODECOR DJ FLEX NEW**

length = 270 cm - pack 10 pcs

		H				
ART.	finishing	8	10	12,5	15	20
<b>ALUMINIUM</b>						
DJAF/	silver anodised	-	95685	95689	-	-
	euro/m	-	7,35	7,67	-	-
<b>BRASS</b>						
DJNF/	natural brass	-	95695	95699	-	-
	euro/m	-	13,97	14,49	-	-

individually packed

DJAF/ and DJNF/ are available in 8, 15 and 20 mm height on request, with a minimum order of 100 pcs for each code.

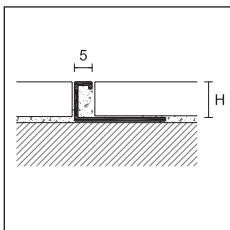

DJAF/  
DJNF/

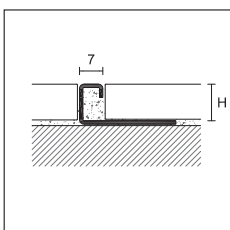

DI/

**PRODECOR**

length = 270 cm - pack 20 pcs

		H				
ART.	finishing	8	10	12,5	15	20
<b>STAINLESS STEEL</b>						
DI/	polished stainless steel AISI 304 DIN 1.4301	95906	95908	95910	95911	95907
	euro/m	10,96	11,38	11,77	12,15	13,30

art. DI/20 pack 10 pcs

## cerfix® prostyle

Prostyle is a line of multi-purpose profiles for the finishing and decoration of floors of same level in ceramic, marble, granite or other types of materials. It is also ideal as separation and decoration joint between floors of different materials and, in the stainless steel version, it is suitable for the protection of ceramic steps and for the surfaces subject to the passage of heavy and frequent loads.

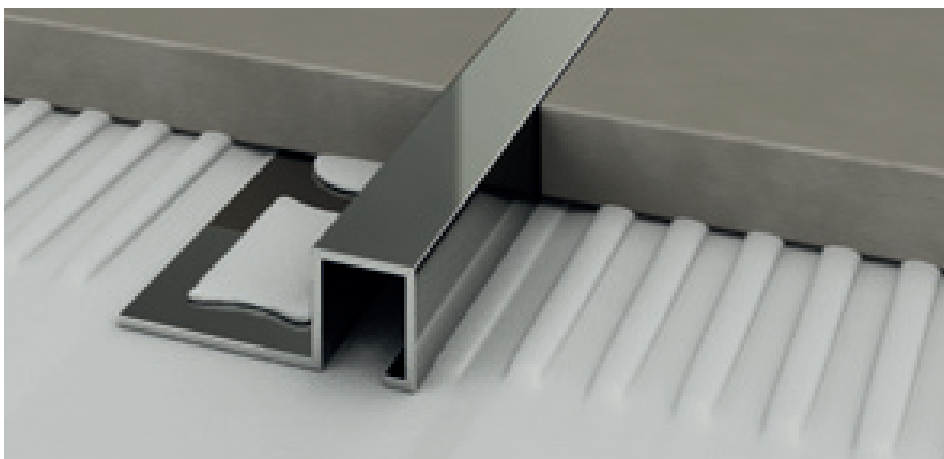

UK/12 chromium-plated brass

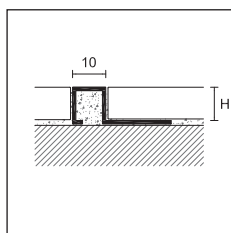

UG/  
UA/  
UN/  
UK/

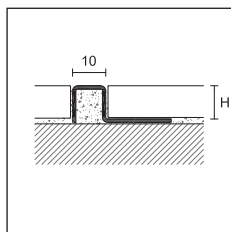

UI/  
UIS/

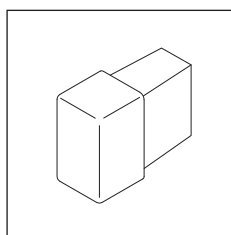

PPDESIGN

### PROSTYLE

length = 270 cm - pack 20 pcs

		H					
ART.	finishing	8	10	11	12,5	15	20
<b>ALUMINIUM</b>							
UG/	natural aluminium	93368	93370	-	93372	93377	-
	euro/m	4,91	5,21	-	5,53	5,97	-
UA/	silver anodised	93378	93380	-	93382	93387	-
	euro/m	6,39	6,72	-	7,06	7,49	-

length = 270 cm - pack 10 pcs

<b>STAINLESS STEEL</b>							
UI/	polished stainless steel AISI 304 DIN 1.4301	93400	93401	-	93402	93403	93404
	euro/m	11,82	12,45	-	13,25	14,06	15,71
UIS/	satin stainless steel AISI 304 DIN 1.4301	93348	93350	-	93352	93360	93361
	euro/m	13,74	14,41	-	15,15	15,97	17,65
<b>BRASS</b>							
UN/	natural brass	93300	93302	93311	93304	93306	93308
	euro/m	13,04	14,94	15,91	16,75	17,58	19,36
UK/	chromium plated	93325	93327	93312	93329	93338	93340
	euro/m	20,80	22,76	23,67	24,63	25,45	27,38

individually packed

### OUTSIDE AND INSIDE CORNERS

pack 5 pcs

		H					
ART.	finishing	8	10	11	12,5	15	20
<b>ALUMINIUM</b>							
UG/ /EI	natural aluminium	93373	93374	-	93375	93376	-
UA/ /EI	silver anodised	93383	93384	-	93385	93386	-
	euro/pc	7,10	7,10	-	7,10	7,10	-
<b>STAINLESS STEEL</b>							
UI/ /EI	polished stainless steel AISI 304 DIN 1.4301	93405	93406	-	93407	93408	93409
	euro/pc	14,81	14,81	-	14,81	14,81	14,81
UIS/ /EI	satin stainless steel AISI 304 DIN 1.4301	93353	93354	-	93355	93356	93357
	euro/pc	17,07	17,07	-	17,07	17,07	17,07
<b>BRASS</b>							
UN/ /EI	natural brass	93301	93303	93341	93305	93307	93309
	euro/pc	15,10	15,10	15,10	15,10	15,10	15,10
UK/ /EI	chromium plated	93334	93335	93342	93336	93337	93339
	euro/pc	17,07	17,07	17,07	17,07	17,07	17,07

no partial packaging

Complete the article code with H measure  
(for example UG/ for H=8 becomes UG/8)

For a single piece, see sales conditions on page 288

Projoint U and Projoint they are a range of separation joints in stainless steel and brass, especially suitable in case of transit of high and frequent loads. The version 799 / in case of need can be inserted and polished even after the installation after the cutting of the flooring.

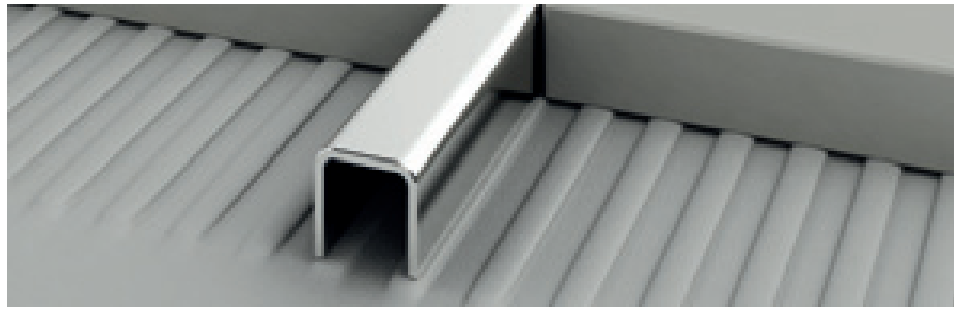

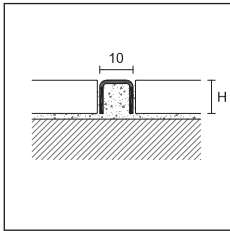

799/U/12 polished stainless steel AISI 304 DIN 1.4301



799/U/  
399/U

**PROJOINT U**

length = 270 cm - pack 20 pcs

H	10	12,5
<b>ART. finishing</b>		
<b>STAINLESS STEEL</b>		
<b>799/U/</b>	polished stainless steel AISI 304 DIN 1.4301	
	75078	75072
	<b>euro/m</b>	<b>8,12</b>
<b>BRASS</b>		
<b>399/U</b>	polished brass	
	75077	-
	<b>euro/m</b>	<b>8,59</b>

individually packed

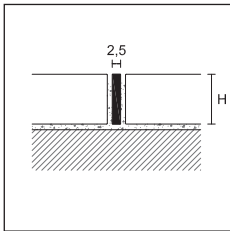

799/

**PROJOINT**

length = 270 cm - pack 20 pcs

H	10
<b>ART. finishing</b>	
<b>STAINLESS STEEL</b>	
<b>799/</b>	stainless steel AISI 304 DIN 1.4301
	
	74966
	<b>euro/m</b>
	<b>5,72</b>

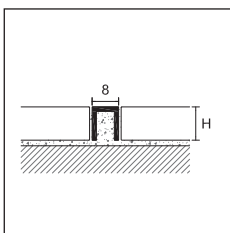

380/8

**PROJOINT**

length = 270 cm - pack 20 pcs

measures LxH	8x10
<b>ART. finishing</b>	
<b>BRASS</b>	
<b>380/8</b>	natural brass
	
	75047
	<b>euro/m</b>
	<b>14,05</b>

Complete the article code with H measure  
(for example 799/U/ for H=10 becomes 799/U/10)

For a single piece, see sales conditions on page 288

# projoint

Projoint T is a line of profiles for the separation, protection and decoration of same-level floors in ceramic, marble, granite, wood or other materials. It is also ideal to cover any imperfections due to the cutting or for the laying of floors made of different materials. Its special section allows to cover slight height differences (2÷3 mm) between two different types of floor. It is also easy to install, thanks to the arrow shape which allows a perfect fixing with sealants or adhesives.



99/T/14 silver anodised aluminium

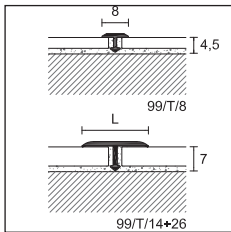

99/T/  
399/T/  
399/TC/

### PROJOINT T

length = 270 cm - pack	50 pcs	50 pcs	30 pcs	20 pcs
<b>width</b>	<b>8</b>	<b>14</b>	<b>20</b>	<b>26</b>

#### ART. finishing

#### ALUMINIUM

silver anodised		75075	75080	63600	75082
gold anodised		-	75083	75084	75085
<b>euro/m</b>		<b>3,18</b>	<b>3,50</b>	<b>3,76</b>	<b>4,61</b>
99/T/ titanium anodised		-	75099	-	-
<b>euro/m</b>		-	<b>4,18</b>	-	-
colour-coated anthracite grey RAL 7016		-	75091	-	-
<b>euro/m</b>		-	<b>7,04</b>	-	-

length = 270 cm - pack	-	10 pcs	-	-
<b>width</b>	-	<b>14</b>	-	-

#### ART. finishing

#### ALUMINIUM decors ALCROM® PLUS

<b>NEW</b> 99/T/ 97 black		-	75095	-	-
<b>euro/m</b>		-	<b>5,33</b>	-	-

individually packed

### PROJOINT T

length = 90 cm - pack 10 pcs / blister	<b>L</b>
<b>ART. finishing</b>	<b>14</b>

#### ALUMINIUM

silver anodised		20008
499/T gold anodised		20010
<b>euro/pc</b>		<b>4,14</b>

### PROJOINT T

length = 270 cm - pack 20 pcs	<b>LxH</b>
<b>ART. finishing</b>	<b>26 X 4,5</b>

#### ALUMINIUM

99/TR/26 silver anodised		75081
<b>euro/m</b>		<b>4,57</b>

individually packed

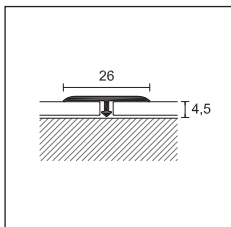

99/TR/26

#### PRO FLEX LINE

Projoint T 99/T/ can be bent with Proflex Machine.

Complete the article code with L measure (for example 99/T/ for L=14 becomes 99/T/14)

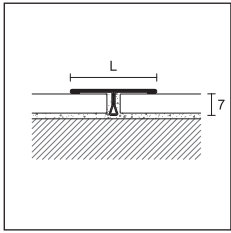

packaging in blister no partial packaging

For a single piece, see sales conditions on page 288





799/T/  
799/TS/

**PROJOINT T**



length = 270 cm - pack		30 pcs	20 pcs	
<b>width</b>		<b>14</b>	<b>26</b>	
<b>ART.</b>	<b>finishing</b>			
<b>STAINLESS STEEL</b>				
<b>799/T/</b>	polished stainless steel AISI 304 DIN 1.4301		75092	75096
	<b>euro/m</b>		<b>9,23</b>	<b>13,53</b>
<b>799/TS/</b>	satin stainless steel AISI 304 DIN 1.4301		75093	75097
	<b>euro/m</b>		<b>11,56</b>	<b>16,43</b>

individually packed

**PROJOINT T**

length = 90 cm - pack 10 pcs / blister				
<b>4799/T</b>	polished stainless steel AISI 304 DIN 1.4301		20001	-
	<b>euro/pc</b>		<b>9,27</b>	-
<b>4799/TS</b>	satin stainless steel AISI 304 DIN 1.4301		20002	-
	<b>euro/pc</b>		<b>11,38</b>	-

**PROJOINT T**

length = 270 cm - pack		50 pcs	20 pcs	20 pcs	20 pcs	
<b>width</b>		<b>8</b>	<b>14</b>	<b>20</b>	<b>26</b>	
<b>ART.</b>	<b>finishing</b>					
<b>BRASS</b>						
<b>399/T/</b>	polished		75070	75087	75090	75088
	<b>euro/m</b>		<b>6,50</b>	<b>6,74</b>	<b>10,16</b>	<b>11,85</b>
pack			30 pcs	30 pcs	-	10 pcs
<b>399/TC/</b>	chromium plated		75071	75086	-	75089
	<b>euro/m</b>		<b>13,16</b>	<b>13,49</b>	-	<b>17,99</b>

individually packed

**PROJOINT T**

length = 90 cm - pack 10 pcs / blister			
<b>4399/T</b>	polished		20016
	<b>euro/pc</b>		<b>7,19</b>

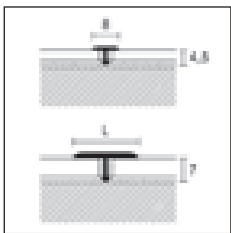

399/T/  
399/TC/

PPDESIGN



799/T/26 polished stainless steel AISI 304 DIN 1.4301



399/T/14 polished brass

**PRO FLEX LINE**

Projoint T 399/T/ and 399/TC/ can be bent with Proflex Machine.

Complete the article code with L measure (for example 799/T/ for L=14 becomes 799/T/14)

For a single piece, see sales conditions on page 288

# profiles for floors of same height

## projoint

Projoint R is a line of profiles for subdivision and / or decoration of floors of the same level in ceramic, marble, granite, wood or other materials. The thickness of the upper part makes it particularly suitable for the polishing of wood, marble, etc...



399/R/10 natural brass

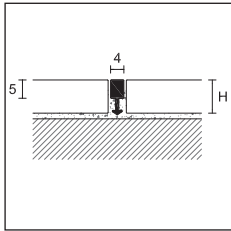

99/R/  
399/R/

### PROJOINT R

length = 270 cm - pack 50 pcs H

ART.	finishing	10	14
------	-----------	----	----

#### ALUMINIUM

99/R/	natural aluminium		75006	75016
	<i>euro/m</i>		<i>2,26</i>	<i>2,75</i>

length = 270 cm - pack 20 pcs H

#### BRASS

399/R/	natural brass		75007	75017
	<i>euro/m</i>		<i>7,63</i>	<i>8,69</i>

length = 90 cm - pack 10 pcs 

#### BRASS

4399/R/10	natural brass		20006	-
	<i>euro/pc</i>		<i>8,37</i>	-

Projoint M is ideal as a separation joint and / or renovation and decoration between floors of the same level laid with glue or mortar. Used between materials of different thickness or type, it could also be polished both in the aluminium and brass version.



399/M natural brass

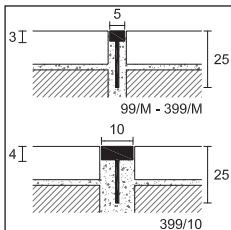

99/M  
399/M  
399/10

### PROJOINT M

length = 270 cm - pack 50 pcs

measures	5x3x25	10x4x25
----------	--------	---------

ART.	finishing		
------	-----------	--	--

#### ALUMINIUM

99/M	natural aluminium		75005	-
	<i>euro/m</i>		<i>3,03</i>	-
	pack		20 pcs	10 pcs

#### BRASS

399/M	natural brass		74975	-
	<i>euro/m</i>		<i>8,93</i>	-

399/10	natural brass		-	74906
	<i>euro/m</i>		-	<i>16,81</i>

Complete the article code with H measure (for example 99/R/ for H=10 becomes 99/R/10)

 packaging in blister no partial packaging

For a single piece, see sales conditions on page 288



Proclassic R is a line of profiles specially designed as threshold cover and to hide junctions and possible imperfections due to the cutting or the laying between floors of different materials. The rounded shape allows to compensate a slight height difference 2÷3 mm) between two different types of floor. The fixing is particularly easy thanks to the possibility to use adhesive or screws.

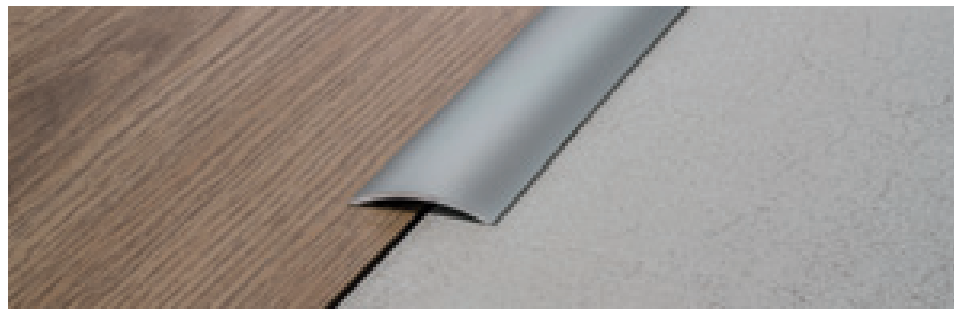

30/A silver anodised aluminium

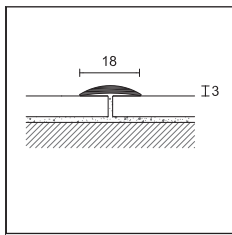

21/

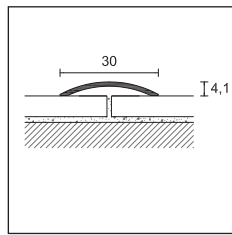

30/

**PROCLASSIC R**

length = 270 cm - pack 20 pcs

ART.	finishing	A
<b>ALUMINIUM</b>		
21/	silver anodised	71037
	<i>euro/m</i>	4,69
	gold anodised	71047
	<i>euro/m</i>	4,69

individually packed

**PROCLASSIC R**

pack	30 pcs				10 pcs / blister							
length cm	270				83	93	103	166				
ART.	30/				430/							
finishing	F	A	CV	AD	CV	AD	CV	AD	CV	AD		
<b>ALUMINIUM</b>												
silver anodised		71067	71097	20128	20148	20132	20152	-	20156	20140	20160	
gold anodised		71077	71107	-	-	20133	20153	-	20157	-	20161	
<i>euro/m</i>		3,65	4,96	-	-	-	-	-	-	-	-	
<i>euro/pc</i>		-	-	4,26	5,04	4,60	5,59	-	6,13	7,86	9,73	
titanium anodised		-	71098	-	-	-	-	-	-	-	-	
<i>euro/m</i>		-	5,50	-	-	-	-	-	-	-	-	
<i>euro/pc</i>		-	-	-	-	-	-	-	-	-	-	
bronze anodised		-	71117	-	-	-	20154	-	-	-	-	
<i>euro/m</i>		-	4,96	-	-	-	-	-	-	-	-	
<i>euro/pc</i>		-	-	-	-	-	5,59	-	-	-	-	
colour-coated anthracite grey RAL 7016		-	71101	-	-	-	-	-	-	-	-	
<i>euro/m</i>		-	8,99	-	-	-	-	-	-	-	-	

individually packed

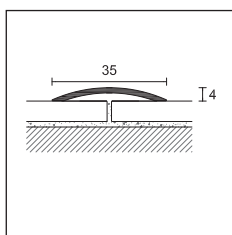

35/

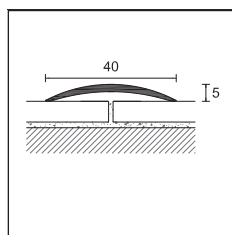

41/

**PROCLASSIC R**

length = 270 cm - pack 20 pcs

ART.	35/	
finishing	F	A
<b>ALUMINIUM</b>		
silver anodised		71387
<i>euro/m</i>		4,68
		71417
		5,96

individually packed

**PROCLASSIC R**

pack	20 pcs		10 pcs / blister
length cm	270		90
ART.	41/		441/
finishing	F	A	AD
<b>ALUMINIUM</b>			
silver anodised		71587	71617
gold anodised		-	71627
<i>euro/m</i>		5,57	6,85
<i>euro/pc</i>		-	7,29
titanium anodised		-	71618
<i>euro/m</i>		-	7,54
<i>euro/pc</i>		-	7,99
bronze anodised		-	71637
<i>euro/m</i>		-	6,85
<i>euro/pc</i>		-	-

individually packed

Complete the article code with F= drilled, A-A-D=adhesive, CV=with screws (for example 30/ becomes 30/F)

packaging in blister no partial packaging

For a single piece, see sales conditions on page 288

# proclassic

Proclassic R in stainless steel is particularly suitable in public spaces and in the case of passage of frequent and heavy loads. The sparkle of polished stainless steel also matches perfectly the modern floors and furnishings.

Proclassic R in polished brass is classic and modern at the same time and can be easily combined to handles, taps and other furniture accessories of the same material and finish.



720/A polished stainless steel AISI 430 DIN 1.4016

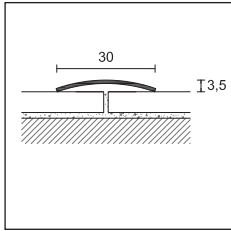

720/  
722/  
020/

### PROCLASSIC R

pack	20 pcs	PRO									
length cm	270	73	83	93	103	166					
ART.	720/	720/									
finishing	F A	F A	F A	F A	F A	F A	F A	F A	F A	F A	
<b>STAINLESS STEEL</b> (thickness 10/10)											
polished stainless steel AISI 430 - DIN 1.4016	71287 71297	71280 71290	71281 71291	71282 71292	- -	- -	- -	- -	- -	71294	
euro/m	3,41 4,97	- -	- -	- -	- -	- -	- -	- -	- -	- -	
euro/pc	- -	2,50 3,64	2,85 4,14	3,19 4,65	- -	- -	- -	- -	- -	8,26	
10 pcs / blister											
ART.	4720/										
finishing		CV AD	CV AD	CV AD	CV AD	CV AD	CV AD	CV AD	CV AD	CV AD	
polished stainless steel AISI 430 - DIN 1.4016	- -	20287 20293	20288 20294	20289 20295	20290 20296	20291 20297					
euro/pc	- -	4,18 4,98	4,59 5,54	4,92 6,01	5,34 6,60	8,23 10,44					
satin stainless steel AISI 430 - DIN 1.4016	- 71298	- -	- -	- -	- -	- -	- -	- -	- -	- -	
euro/m	- 5,87	- -	- -	- -	- -	- -	- -	- -	- -	- -	

individually packed

### PROCLASSIC R

pack	20 pcs	10 pcs / blister									
length cm	270	73	83	93	103	166					
ART.	722/	4722/									
finishing	- A	CV AD	CV AD	CV AD	CV AD	CV AD	CV AD	CV AD	CV AD	CV AD	
<b>STAINLESS STEEL</b> (thickness 10/10)											
satin stainless steel AISI 304 - DIN 1.4301	- 71268	- -	- -	- 20300	- -	- -	- -	- -	- -	- -	
euro/m	- 8,15	- -	- -	- -	- -	- -	- -	- -	- -	- -	
euro/pc	- -	- -	- -	- 8,51	- -	- -	- -	- -	- -	- -	

individually packed

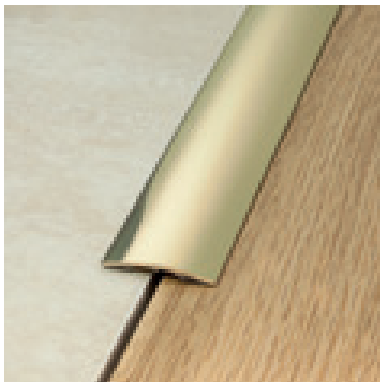

020/A polished brass

### PROCLASSIC R

pack	20 pcs	10 pcs / blister									
length cm	270	73	83	93	103	166					
ART.	020/	4020/									
finishing	F A	CV AD	CV AD	CV AD	CV AD	CV AD	CV AD	CV AD	CV AD	CV AD	
<b>BRASS</b> (thickness 10/10)											
polished	71187 71207	20207 20213	20208 20214	20209 20215	20210 20216	20211 20217					
euro/m	6,99 8,66	- -	- -	- -	- -	- -					
euro/pc	- -	6,54 7,45	7,35 8,31	8,02 9,27	8,85 10,19	13,87 16,21					

individually packed

Complete the article code with F= drilled, A=adhesive, CV=with screws (for example 720/ drilled becomes 720/F)

packaging in blister no partial packaging

For a single piece, see sales conditions on page 288

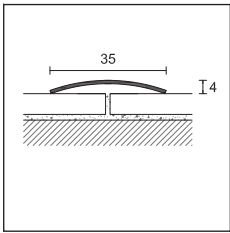

726/

**PROCLASSIC R**

pack	20 pcs	PRO			
length	270	83	93	166	
ART.	726/	726/			
finishing	F A	F A	F A	F A	F A

**STAINLESS STEEL** (thickness 10/10)

polished stainless steel AISI 430 - DIN 1.4016		71507	71517	-	-	71502	71512	-	-
<b>euro/m</b>		5,10	6,35	-	-	-	-	-	-
<b>euro/pc</b>		-	-	-	-	4,74	5,92	-	-

10 pcs / blister

ART.	4726/						
finishing		CV	AD	CV	AD	CV	AD
polished stainless steel AISI 430 - DIN 1.4016		-	26016	26010	26017	-	26019
<b>euro/pc</b>		-	6,15	5,91	6,85	-	11,99

satin stainless steel AISI 430 - DIN 1.4016		-	71518	-	-	-	-
<b>euro/m</b>		-	7,42	-	-	-	-

individually packed

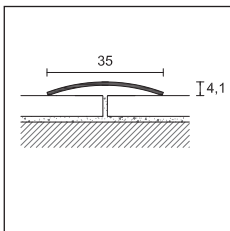

026/

**PROCLASSIC R**

pack	20 pcs	10 pcs / blister
thickness =10/10 - length cm	270	93
ART.	026/	4026/
finishing	F A	CV AD

**BRASS** (thickness 10/10)

polished		71447	71457	20409	20415
<b>euro/m</b>		9,29	11,19	-	-
<b>euro/pc</b>		-	-	10,38	11,79

individually packed

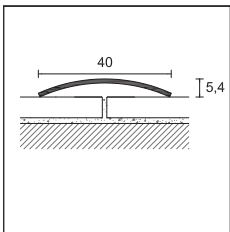

729/

**PROCLASSIC R**

pack	20 pcs	5 pcs / blister
length	270	93
ART.	729/	4729/
finishing	F A	CV AD

**STAINLESS STEEL** (thickness 12/10)

polished stainless steel AISI 430 - DIN 1.4016		71667	71677	-	40220
<b>euro/m</b>		7,50	8,89	-	-
<b>euro/pc</b>		-	-	-	9,31
satin stainless steel AISI 430 - DIN 1.4016		-	71678	-	-
<b>euro/m</b>		-	10,47	-	-

individually packed

Complete the article code with F= drilled, A-A-D=adhesive, CV=with screws (for example 726/ drilled becomes 726/F)

packaging in blister no partial packaging

For a single piece, see sales conditions on page 288



722/A satin stainless steel AISI 304 DIN 1.4301

# proclassic

Proclassic F is a line of threshold cover profiles F with a thickness that allows the application under the doors. 19/ and 25/ are provided with a useful non-slip knurled surface. The installation is particularly simple, thanks to the possibility to use adhesive or screws.

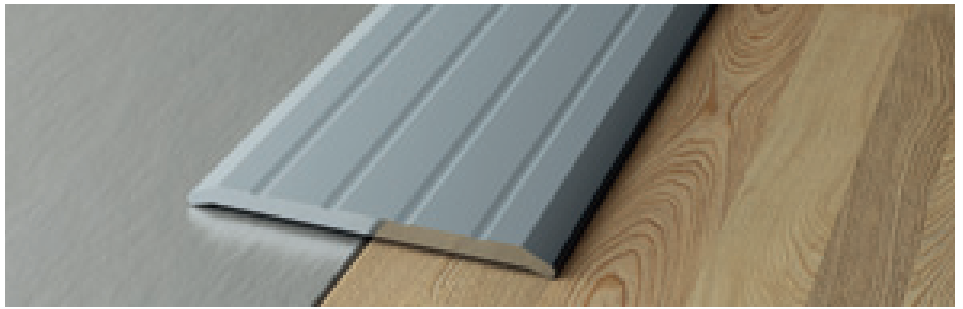

25/A silver anodised aluminium

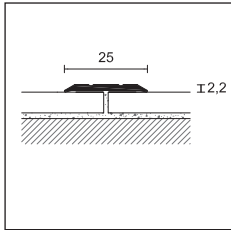

19/

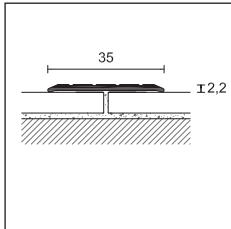

25/

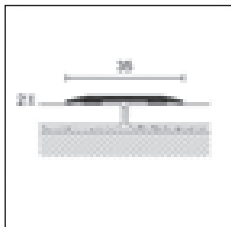

22/A  
422/AD





Complete the article code with F=drilled, A/AD=adhesive, CV=with screws (for example 19/F)

**NEW**

 packaging in blister no partial packaging





For a single piece, see sales conditions on page 288

## PROCLASSIC F

pack	30 pcs		10 pcs / blister 		
length cm	270		93		
ART.	19/		419/		
finishing	F	A	CV	AD	
<b>ALUMINIUM</b>					
silver anodised		71867	71897	27074	27092
euro/m		3,43	4,60	-	-
euro/pc		-	-	4,31	5,21
gold anodised		-	71907	27080	27099
euro/m		-	4,60	-	-
euro/pc		-	-	4,31	5,21
bronze anodised		-	71917	-	-
euro/m		-	4,60	-	-
euro/pc		-	-	-	-



individually packed

## PROCLASSIC F

pack	20 pcs			10 pcs / blister 		
length cm	270			93		
ART.	25/			425/		
finishing	F	D	A	CV	AD	
<b>ALUMINIUM</b>						
silver anodised		71947	71948	71977	22533	22553
euro/m		4,24	4,24	5,54	-	-
euro/pc		-	-	-	5,07	5,96
gold anodised		71957	-	71987	22534	22554
euro/m		4,24	-	5,54	-	-
euro/pc		-	-	-	5,07	5,96
bronze anodised		-	-	71997	-	22555
euro/m		-	-	5,54	-	-
euro/pc		-	-	-	-	5,96

individually packed

## PROCLASSIC F

pack	10 pcs		10 pcs / blister 	
length cm	270		90	
ART.	22/A		422/AD	
finishing				
<b>ALUMINIUM</b>				
silver		44000	43790	
euro/m		5,58	-	
euro/pc		-	6,43	
titanium		44001	43791	
euro/m		6,55	-	
euro/pc		-	7,28	



## ALUMINIUM - decors ALCROM® PLUS

black 97		43996	-	
euro/m		8,12	-	
euro/pc		-	-	

Wood-effect decors available on page 182 and 183





**PROCLASSIC F**

pack	20 pcs			10 pcs / blister 	10 pcs
length cm	270			90	270
measures LxH	<b>15x1,8</b>	<b>20x1,8</b>	<b>30x2,5</b>	<b>30x2,5</b>	<b>40x2,5</b> thickness 10/10
<b>ART.</b>	<b>723/A</b>	<b>724/A</b>	<b>730/A</b>	<b>4730/AD</b>	<b>740/A</b>
<b>STAINLESS STEEL</b>					
polished stainless steel AISI 430 - DIN 1.4016 	71717	71777	72117	20692	72377
<b>euro/m</b>	<b>5,49</b>	<b>5,94</b>	<b>6,38</b>	-	<b>9,20</b>
<b>euro/pc</b>	-	-	-	<b>6,38</b>	-

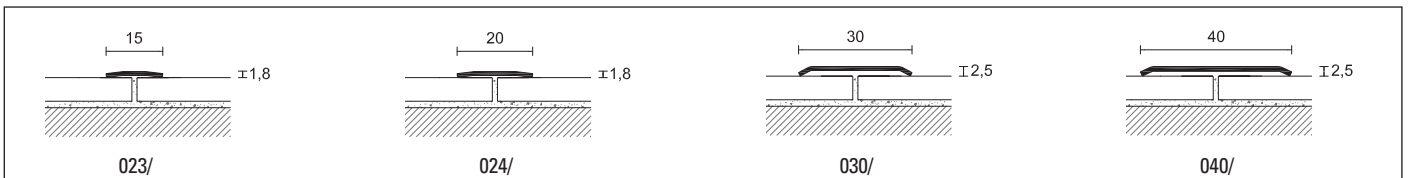
art. 723/ no individually packed - art. 730/ and 740/ individually packed



**PROCLASSIC F**

pack	20 pcs			10 pcs / blister 	10 pcs
thickness 10/10 - length cm	270			90	270
measures LxH	<b>15x1,8</b>	<b>20x1,8</b>	<b>30x2,5</b>	<b>30x2,5</b>	<b>40x2,5</b>
<b>ART.</b>	<b>023/A</b>	<b>024/A</b>	<b>030/A</b>	<b>4030/AD</b>	<b>040/A</b>
<b>BRASS</b>					
polished 	71697	71757	72057	20612	72317
<b>euro/m</b>	<b>9,14</b>	<b>10,09</b>	<b>10,37</b>	-	<b>13,07</b>
<b>euro/pc</b>	-	-	-	<b>11,09</b>	-

art. 030/ and 040/ individually packed - art. 023/ and 024/ not individually packed



 packaging in blister no partial packaging

For a single piece, see sales conditions on page 288 22/A aluminium covered with Alcrom® Plus black 97





## profiles for floors of different height

The range of profiles for floors of different height is made with a sloping section and allows to connect floors with different thicknesses. Products made of stainless steel, brass or aluminium, are chosen according to the target environment.

cerfix® pronivel

Pronivel NZS / is a line of connection between floors of different level composed by a bearing profile and two connection wings of different size. Together the two pieces allow the elimination of the step between floors of different thickness. The articulated connector permits many combinations and the laying of a new flooring on the side of the connector, even after the application of NZS /.

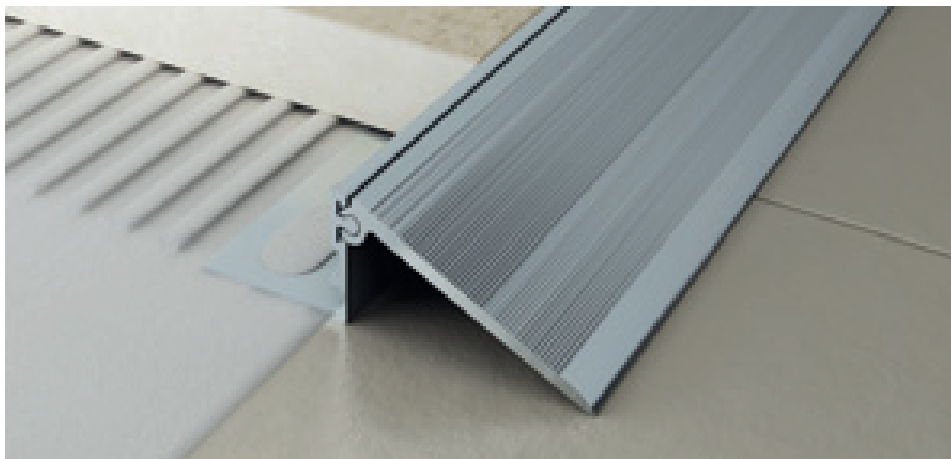

NZS/B/12 + NZS/S2 silver anodised aluminium

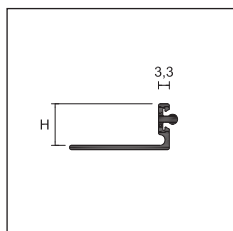

NZS/B/

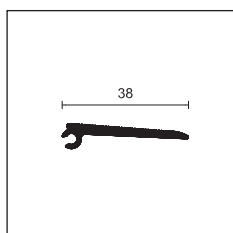

NZS/S1

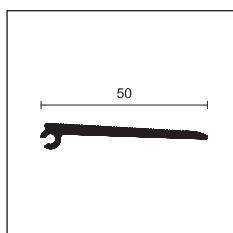

NZS/S2

PRONIVEL N

length = 270 cm - pack 10 pcs

		H			
ART.	finishing	10	12,5	15	20
<b>ALUMINIUM</b>					
NZS/B/	silver anodised	99905	99906	99907	99908
	euro/m	7,77	8,00	8,42	8,97
		L			
		38	50		
NZS/S1	connection silver anodised	99900	-		
NZS/S2	connection silver anodised	-	99901		
	euro/m	9,69	11,19		

individually packed

Complete the article code with H measure (eg. NZS/B/ for H=10 becomes NZS/B/10)

For a single piece, see sales conditions on page 288



Pronivel P is a line of profiles to be applied during the laying of ceramic or marble flooring and suitable for connect different thicknesses. The versions in stainless steel and brass are suitable to withstand heavy stress.

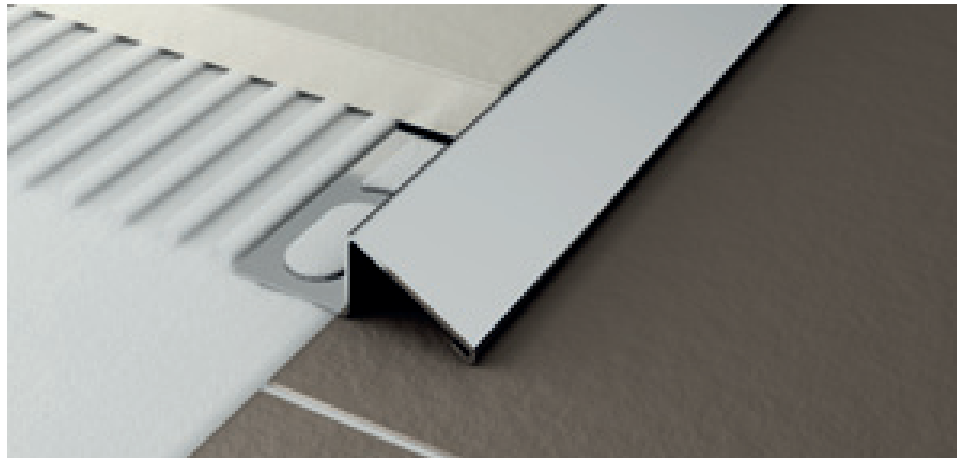

PNI/10 polished stainless steel AISI 304 DIN 1.4301

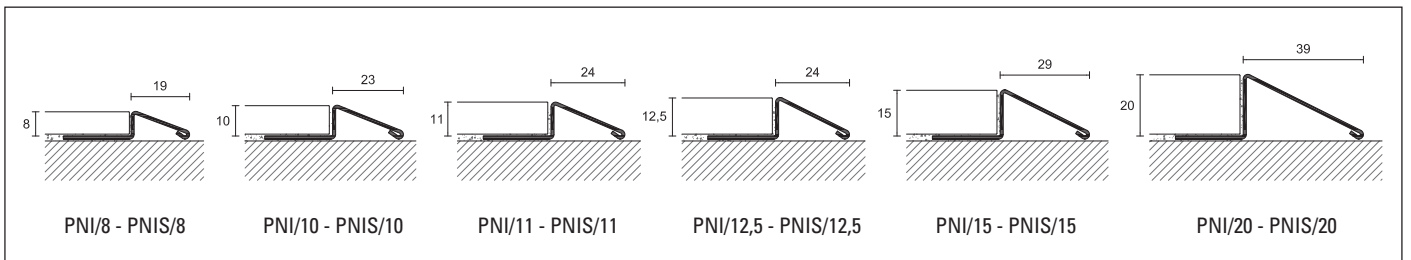
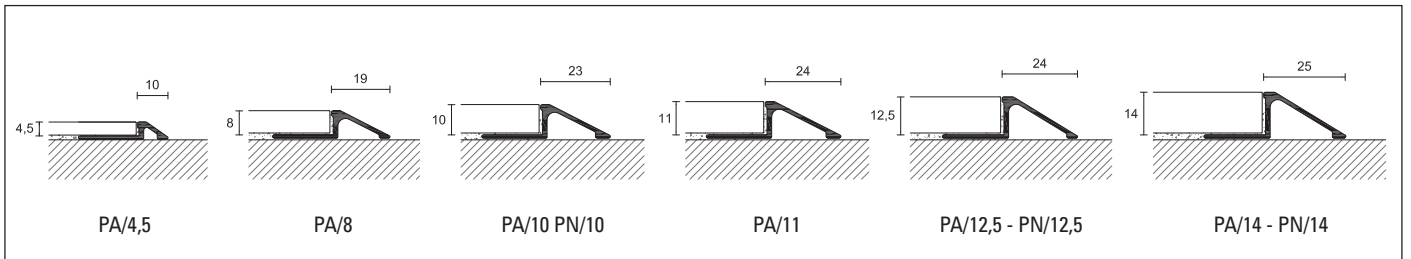

**PRONIVEL P**

length = 270 cm - pack 10 pcs

		H							
ART.	finishing	4,5	8	10	11	12,5	14	15	20
<b>ALUMINIUM</b>									
PA/	silver anodised	93175	93181	93182	93185	93183	93184	-	-
	<i>euro/m</i>	5,59	5,89	6,32	6,72	6,99	7,35	-	-
<b>STAINLESS STEEL</b>									
PNI/	polished stainless steel AISI 304 DIN 1.4301	-	93092	93094	93090	93096	-	93098	93100
	<i>euro/m</i>	-	12,35	13,38	14,11	14,88	-	15,63	17,87
PNIS/	satin stainless steel AISI 304 DIN 1.4301	-	93093	93095	93091	93097	-	93099	93101
	<i>euro/m</i>	-	12,85	15,93	16,54	17,18	-	18,27	20,49
<b>BRASS</b>									
PN/	natural brass	-	-	93122	-	93123	-	-	-
	<i>euro/m</i>	-	-	17,35	-	21,61	-	-	-

individually packed

Complete the article code with H measure (eg. PA/ for H=8 becomes PA/8)

For a single piece, see sales conditions on page 288

# profiles for floors of different height

## cerfix® pronivel

Pronivel L is a profile suitable to connect floors of different heights. Applicable on flooring already laid, it is fixed to the floor with adhesive.



45/SF silver anodised aluminium

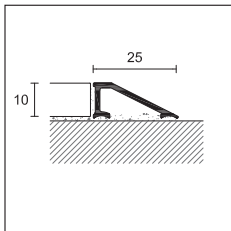

45/

### PRONIVEL L

length = 270 cm - pack 20 pcs

ART. finishing

H

10

SF

A

### ALUMINIUM

45/ silver anodised



73550

73552

euro/m

5,50

6,76

individually packed

Pronivel PB is a transition profile between two floors subject to stress. The slight slope makes easier the passing of trolleys or wheelchairs.

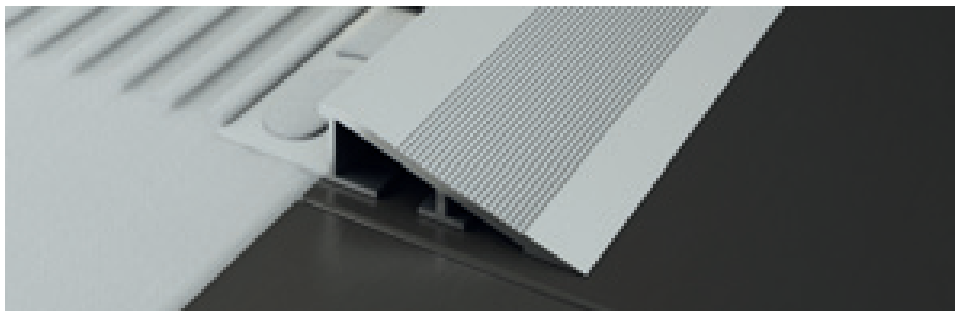

PBA/10 silver anodised aluminium

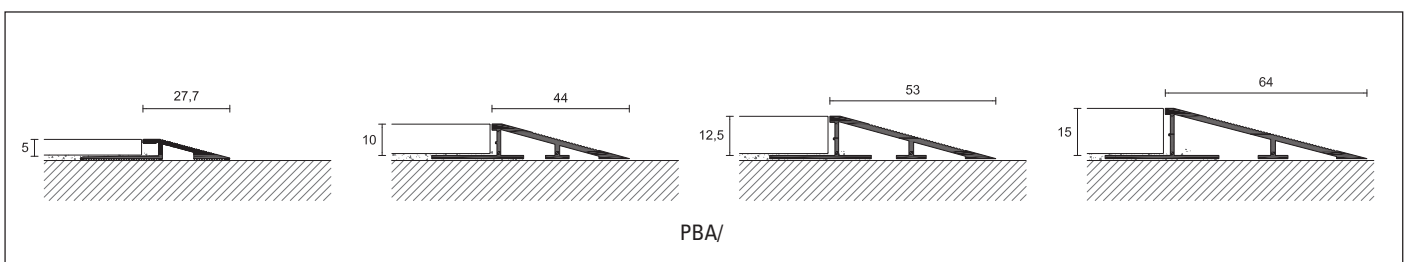

### PRONIVEL PB

length = 270 cm - pack 10 pcs

ART. finishing

5

10

12,5

15

### ALUMINIUM

PBA/ silver anodised



93204

93206

93208

93210

euro/m

7,78

15,46

17,77

20,40

individually packed

Complete the article code with SF=undrilled, A=adhesive, (eg. 45/ adhesive becomes 45/A)

Complete the article code with H measure (eg. PBA/ for H=10 becomes PBA/10)

For a single piece, see sales conditions on page 288

Pronivel Flex is a line of bendable profiles for the connection of different level floors. These profiles can be curved through our Proflex Machine and the specific wheels kit.



PLAF/10 silver anodised aluminium

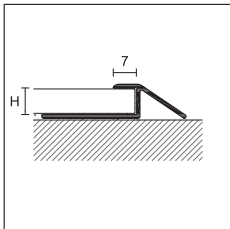

PLAF/

PRO FLEX LINE

**PRONIVEL FLEX**

length = 270 cm - pack 10 pcs

		H		
ART.	finishing	8	10	
<b>ALUMINIUM</b>				
PLAF/	silver anodised	93190	93192	
	euro/m	8,56	9,90	

individually packed

Pronivel M is a line of profiles designed to connect during installation floors of different heights. The special section is effective in case of connection with carpet or LVT.



MIN/10 polished stainless steel AISI 304 DIN 1.4301

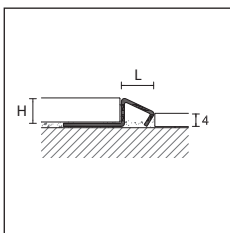

MIN/

**PRONIVEL M**

length = 270 cm - pack 10 pcs

		H		
ART.	finishing	8	10	12,5
<b>STAINLESS STEEL</b>				
MIN/	polished stainless steel AISI 304 DIN 1.4301	93023	93024	-
	euro/m	10,12	11,12	-

individually packed

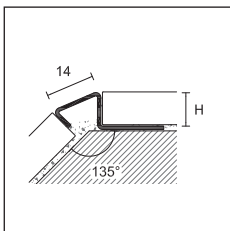

MIN/

Complete the article code with H measure (for example PLAF/ for H=8 becomes PLAF/8)

Complete the article code with H measure (for example MIN/ for H=10 becomes MIN/10)

For a single piece, see sales conditions on page 288

## prolevel

Prolevel 61/ is a line of profiles to be applied after the installation, and can compensate for differences in height between 6.5 and 13 mm.



61/A silver anodised aluminium

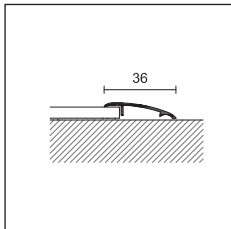

61/

### PROLEVEL HIGH

pack	20 pcs	10 pcs / blister 
length cm	270	90
ART.	61/	461/
finishing	A	AD

### ALUMINIUM

silver anodised 	73437	21200
euro/m	5,84	-
euro/pc	-	6,20

art. 61/ individually packed

Prolevel High 55/ and 57/ are two profiles in aluminium that allows to remove the small step between two floors with a respective difference in height of 8 and 12 mm. Available also in blister pack and with adhesive, they can be easily used in DIY installations.



57/A silver anodised aluminium

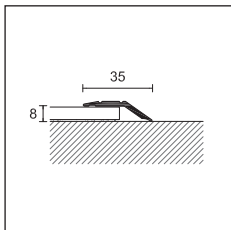



55/

### PROLEVEL HIGH

pack	20 pcs	10 pcs / blister 		
length cm	270	90		
ART.	55/	455/		
finishing	F	A	CV	AD

### ALUMINIUM

silver anodised 	73907	73937	42312	42330
gold anodised 	-	73947	-	42336
euro/m	6,86	8,10	-	-
euro/pc	-	-	7,28	8,20

art. 55/ individually packed

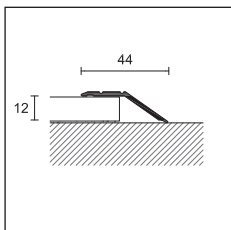



57/

### PROLEVEL HIGH

pack	20 pcs	10 pcs / blister 		
length cm	270	90		
ART.	57/	457/		
finishing	F	A	CV	AD

### ALUMINIUM

silver anodised 	73967	73997	42352	42370
gold anodised 	-	74007	-	42376
euro/m	7,67	8,91	-	-
euro/pc	-	-	8,04	8,91

art. 57/ individually packed

Complete the item code with F=drilled, A-AD=adhesive, CV=screws (eg. 61/ adhesive becomes 61/A)

 packaging in blister no partial packaging

For a single piece, see sales conditions on page 288

Prolevel 711/ and 311/ are a line of self-adhesive stainless steel and polished brass profiles which allows the elimination of the step between floors with 7 or 12 mm slope. Available also in blister pack and self-adhesive, they are easily applicable in DIY field.

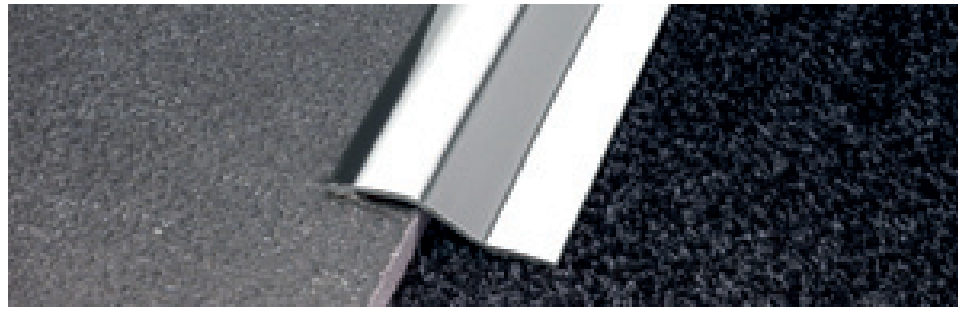

711/A polished stainless steel AISI 430 - DIN 1.4016

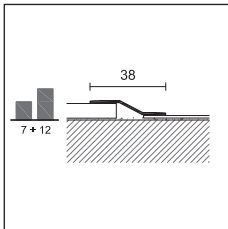

711/  
311/

**PROLEVEL HIGH**

pack	20 pcs	10 pcs / blister	
length cm	270	83	93
ART.	711/	4711/	
finishing	A	AD	AD
<b>STAINLESS STEEL</b>			
polished stainless steel AISI 430 - DIN 1.4016	73627	40431	40432
euro/m	8,49	-	-
euro/pc	-	8,12	8,96
satin stainless steel AISI 430 - DIN 1.4016	73628	-	-
euro/m	10,00	-	-
ART.	311/	4311/	
finishing	A	AD	AD
<b>BRASS</b>			
polished	73607	-	22656
euro/m	13,10	-	-
euro/pc	-	-	13,57

art. 711/ and 311/ individually packed

Prolevel 712/ and 312/ are a line of self-adhesive stainless steel and polished brass profiles which allows the elimination of the step between floors with 12 or 16 mm slope. Available also in blister pack and self-adhesive, they are easily applicable in DIY field.



312/A polished brass

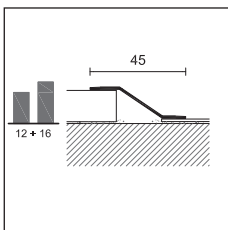

712/  
312/

**PROLEVEL HIGH**

pack	10 pcs	5 pcs / blister	
length cm	270	90	
ART.	712/	4712/	
finishing	A	AD	
<b>STAINLESS STEEL</b>			
polished stainless steel AISI 430 - DIN 1.4016	73637	40898	
euro/m	12,99	-	
euro/pc	-	12,75	
ART.	312/	4312/	
finishing	A	AD	
<b>BRASS</b>			
polished	73617	40868	
euro/m	19,67	-	
euro/pc	-	19,67	

art. 712/ e 312/ individually packed

Complete the item code with A - AD=adhesive (eg. 711/ adhesive becomes 711/A) - packaging in blister no partial packaging  
For a single piece, see sales conditions on page 288

## prolevel

Prolevel High 732/ is a line of profiles for the protection of the perimetral border of floors. Available in stainless steel, it can be also used as stair nosing.



732/SF/10 polished stainless steel AISI 430 DIN 1.4016

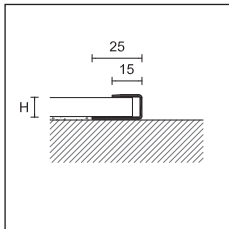

732/SF/

### PROLEVEL HIGH

length = 270 cm - pack 15 pcs

ART.	finishing	10	12,5	15
<b>STAINLESS STEEL</b>				
732/SF/	polished stainless steel AISI 430 DIN 1.4016	74217	74227	74237
	<i>euro/m</i>	11,19	12,20	12,20

individually packed

Prolevel 700/, 300/ and 10/ are a line of transition profiles for floors of small thickness already laid. Available in different widths and also in blister pack, self-adhesive and with screws, they are easily applicable in DIY field.



700/A polished stainless steel AISI 430 DIN 1.4016

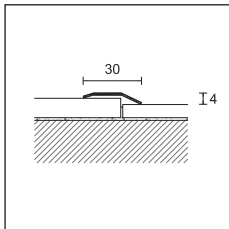

700/  
300/

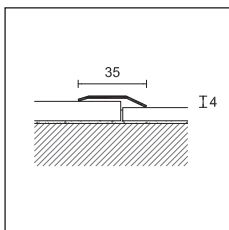

701/

### PROLEVEL MEDIUM

pack	20 pcs		10 pcs / blister
length cm	270	270	93
ART.	700/	701/	4701/
finishing	A	F A	AD
<b>STAINLESS STEEL</b>			
polished stainless steel AISI 430 DIN 1.4016	72877	- 72957	21135
<i>euro/m</i>	5,91	- 6,72	-
<i>euro/pc</i>	-	-	7,23

art. 700/ and 701/ individually packed

### PROLEVEL MEDIUM

pack	20 pcs	10 pcs / blister
length cm	270	93
ART.	300/	4300/
finishing	A	AD
<b>BRASS</b>		
polished	72857	21035
<i>euro/m</i>	10,37	-
<i>euro/pc</i>	-	11,09

art. 300/ individually packed

Complete the article code with F=drilled, A-AD=adhesive, CV=screws (eg. 700/ drilled becomes 700/F)

 packaging in blister no partial packaging

For a single piece, see sales conditions on page 288

Prolevel 6/ is a line of transition profiles in aluminium, for floors of small thickness already laid. Available also in blister pack, self-adhesive and with screws, they are easily applicable in DIY field.

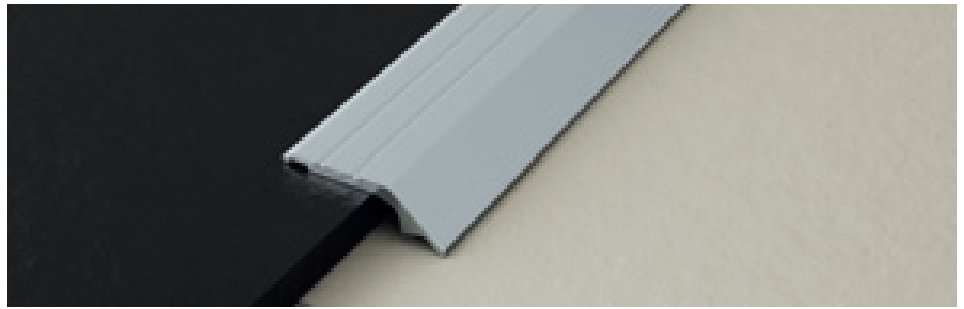

6/A silver anodised aluminium

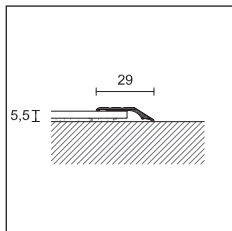

6/

**PROLEVEL MEDIUM**

pack	30 pcs		10 pcs / blister			
length cm	270		93	166		
ART.	6/		46/			
finishing	F	A	CV	AD	CV	AD
<b>ALUMINIUM</b>						
silver anodised		72727 72757	20932	20952	20940	20960
gold anodised		72737 72767	20933	20953	-	-
bronze anodised		- 72777	-	-	-	-
euro/m		4,26 5,45	-	-	-	-
euro/pc		- -	5,06	5,96	8,68	10,43

art. 6/ individually packed

Prolevel Medium 10/ and Prolevel Thin 54/ are two profiles for the connection of PVC floors. They can be installed on already-laid floors and they also acts as protection of the floor edge.



54/A gold anodised aluminium

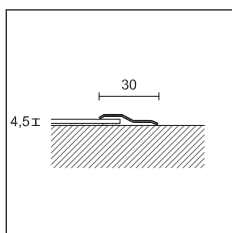

10/

**PROLEVEL MEDIUM**

pack	20 pcs	
length cm	270	
ART.	10/	
finishing	A	
<b>ALUMINIUM</b>		
silver anodised		72527
euro/m		5,04

individually packed

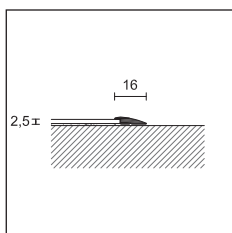

54/

**PROLEVEL THIN**

length = 270 cm - pack 20 pcs			
ART.	finishing	SF	A
<b>ALUMINIUM</b>			
54/	silver anodised		72587 72617
	gold anodised		- 72627
	euro/m		3,83 4,91

individually packed

Complete the item code with SF=undrilled, A-AD=adhesive, (eg. 54/ undrilled becomes 54/SF)

packaging in blister no partial packaging

For a single piece, see sales conditions on page 288







## movement joints

A line designed to permit the expansion and contraction that materials undergo as a result of the seasonal temperature. A wide range of finishes to suit different stresses to which the coating is subjected.

# movement joints

## cerfix® projoint

Projoint DIL NE is an expansion joint in co-extruded PVC. Suitable for the laying with glue, it is available in three colors and four heights and it is suitable for large areas with pedestrian traffic. Set on the joints created on the screed, it allows to absorb stresses of compression and expansion.

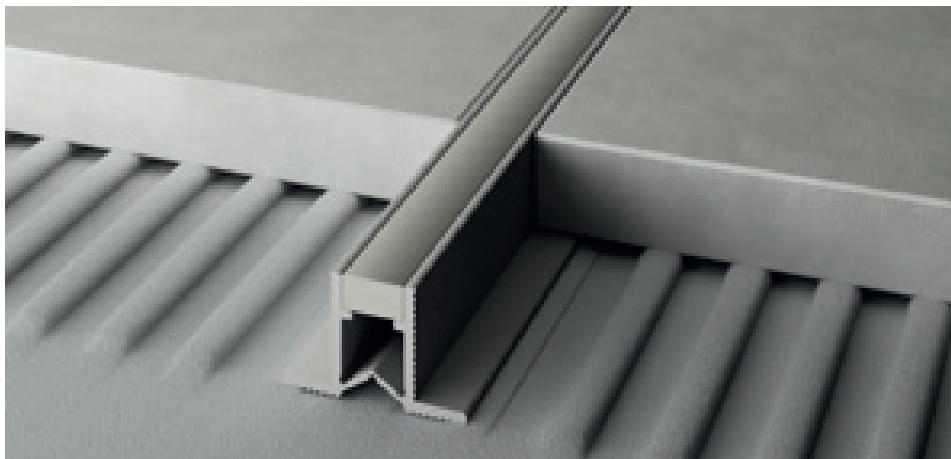

NE/10 co-extruded PVC grey + grey RAL 7035

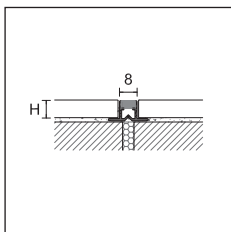

NE/

### PROJOINT DIL

length = 270 cm

		H			
ART.	finishing	8	10	12,5	15
<b>CO-EXTRUDED PVC</b>					
	grey+grey RAL 7035	99650	99660	99670	99680
<b>NE/</b>	stone grey+ stone grey RAL 7030	99653	99663	99673	99683
	cream white+cream white RAL 9001	99652	99662	-	-
<b>pack 20 pcs euro/m</b>		<b>1,21</b>	<b>1,33</b>	<b>1,45</b>	<b>1,58</b>
<b>pack 100 pcs euro/m</b>		<b>1,00</b>	<b>1,12</b>	<b>1,24</b>	<b>1,37</b>

no partial packaging

Projoint DIL NJ/ is an expansion joint in co-extruded PVC with perforated side flanges. Suitable for floors laid with glue, it is able to absorb tensile and compression stresses, thanks to the elastic central part. Made of PVC non-toxic and anti shock, UV resistant and it can be used indoors and outdoors.

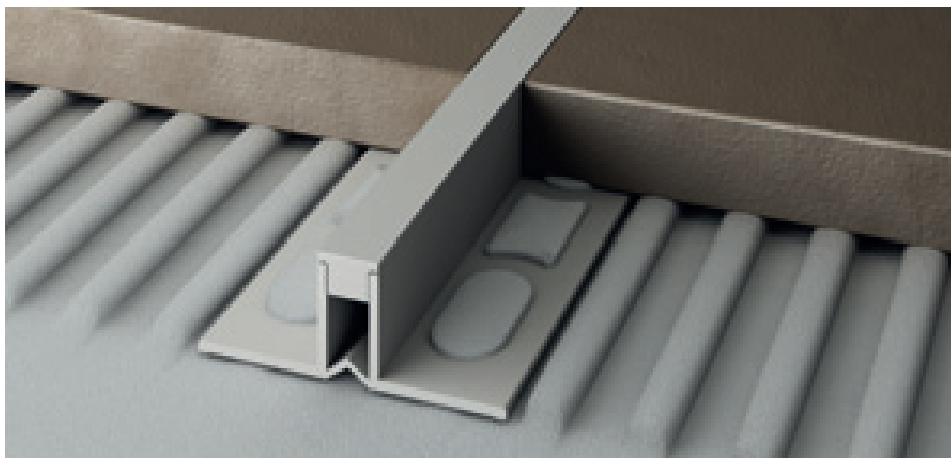

NJ/10 PVC co-extruded PVC light grey RAL 7035

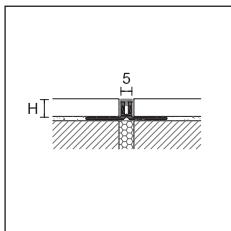

NJ/

### PROJOINT DIL

length = 270 cm - pack 20 pcs

		H				
ART.	finishing	4,5	8	10	12,5	15
<b>CO-EXTRUDED PVC</b>						
	light grey RAL 7035	99757	99750	99760	99770	99780
<b>NJ/</b>	stone grey RAL 7030	99758	99752	99762	99772	99782
<b>euro/m</b>		<b>2,95</b>	<b>3,38</b>	<b>3,71</b>	<b>4,04</b>	<b>4,36</b>

no partial packaging

Complete the article code with H measure (for example NE/ for H=8 becomes NE/8)

For a single piece, see sales conditions on page 288

Projoint DIL NL/ is an expansion joint in co-extruded PVC with perforated side flanges. Suitable for floors or marble laid with glue, it is able to absorb tensile and compression stresses thanks to the elastic central part. It is suitable for both pedestrian traffic and light driveway (car and transpallet). Made of PVC non-toxic and anti shock, UV resistant and it can be used indoors and outdoors.



NL/10 co-extruded PVC grey + grey RAL 7035

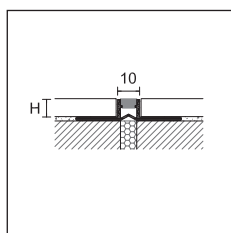

NL/

**PROJOINT DIL**

length = 270 cm - pack 20 pcs

		H				
ART.	finishing	8	10	12,5	15	20
<b>CO-EXTRUDED PVC</b>						
NL/	grey+grey RAL 7035	99700	99710	99720	-	-
	stone grey+ stone grey RAL 7030	99704	99714	99724	99734	99744
	black+black RAL 9005	99703	99713	99723	-	-
<b>euro/m</b>		<b>3,80</b>	<b>4,23</b>	<b>4,69</b>	<b>5,12</b>	<b>6,05</b>

no partial packaging

Projoint DIL NF is an expansion joint in co-extruded PVC for the laying with mortar. Available in three colors and three heights, it is suitable to divide large areas with pedestrian traffic. It allows to absorb compressive and expansion stresses.

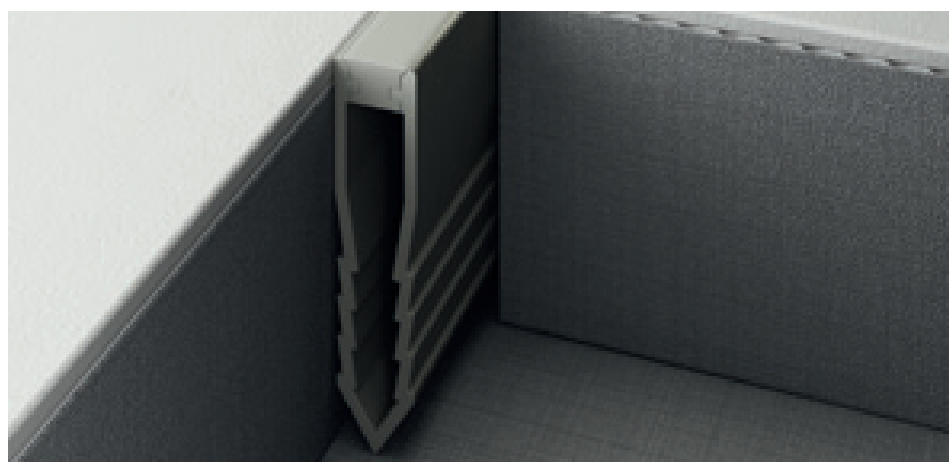

NF/45 co-extruded PVC grey + grey RAL 7035

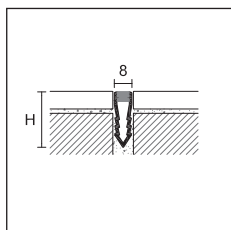

NF/

**PROJOINT DIL**

length = 270 cm

		H		
ART.	finishing	25	35	45
<b>CO-EXTRUDED PVC</b>				
NF/	grey+grey RAL 7035	99800	99810	99820
	stone grey+ stone grey RAL 7030	99803	99813	99823
	cream white+cream white RAL 9001	99802	99812	-
<b>pack 20 pcs</b>				
<b>euro/m</b>		<b>1,73</b>	<b>1,97</b>	<b>2,39</b>
<b>pack 40 pcs</b>				
<b>euro/m</b>		-	-	<b>2,15</b>
<b>pack 50 pcs</b>				
<b>euro/m</b>		-	<b>1,73</b>	-
<b>pack 80 pcs</b>				
<b>euro/m</b>		<b>1,49</b>	-	-

no partial packaging

Complete the article code with H measure (for example NL/ for H=10 becomes NL/10)

For a single piece, see sales conditions on page 288

# movement joints

## cerfix® projoint

Projoint DIL NAN is an expansion joint in aluminium, with an interchangeable insert in elastic vinyl resin, characterized by a visible section of 15 mm. The structure of the joint allows to protect the edge of the tile and is able to withstand high traffic, both pedestrian and vehicular.



NAN/10 natural aluminium + stone grey rubber

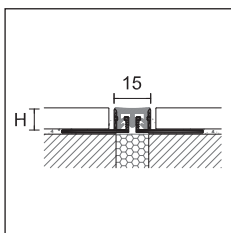

NAN/

### PROJOINT DIL

length = 270 cm - pack 10 pcs

		H		
ART.	finishing	10	12,5	15
<b>ALUMINIUM</b>				
NAN/	natural aluminium + grey RAL 7035 rubber	99974	99975	99976
	natural aluminium + stone grey RAL 7030 rubber	99977	99978	99979
<i>euro/m</i>		<b>13,13</b>	<b>13,50</b>	<b>14,15</b>

individually packed - NAN/ available with black rubber upon request, minimum order 100 pcs

### SPARE INSERT FOR NAN/

length= 270 cm - pack 20 pcs

ART.	finishing		
GM/	grey RAL 7035		99993
	stone grey RAL 7030		99989
<i>euro/m</i>			<b>3,02</b>

Projoint DIL NPAN/ is an expansion joint in aluminium, with an interchangeable insert in elastic vinyl resin, characterized by a visible section of 21 mm. The structure of the joint allows to protect the edge of the tile and is able to withstand high traffic, both pedestrian and vehicular.



NPAN/10 natural aluminium + stone grey rubber

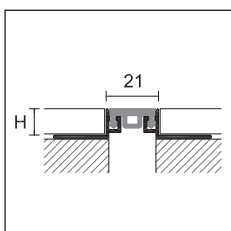

NPAN/

### PROJOINT DIL

length = 270 cm - pack 10 pcs

		H		
ART.	finishing	10	12,5	15
<b>ALUMINIUM</b>				
NPAN/	natural aluminium + stone grey RAL 7030 rubber	99984	99985	99986
	<i>euro/m</i>	<b>13,44</b>	<b>13,84</b>	<b>14,57</b>

individually packed - NPAN/ available with black rubber upon request, minimum order 100 pcs

### SPARE INSERT FOR NPAN/

length= 270 cm - pack 20 pcs

ART.	finishing		
GMP/	stone grey RAL 7030		99988
<i>euro/m</i>			<b>3,41</b>

Complete the article code with H measure (for example NAN/ for H=10 becomes NAN/10)

For a single piece, see sales conditions on page 288

Projoint DIL NIN/ is an expansion joint in stainless steel, with an interchangeable insert in elastic vinyl resin, characterized by a reduced section of 15 mm. The structure of the joint allows to protect the edge of the tile and is able to withstand heavy traffic, both pedestrian and vehicular (forklifts, transpallets and cars).

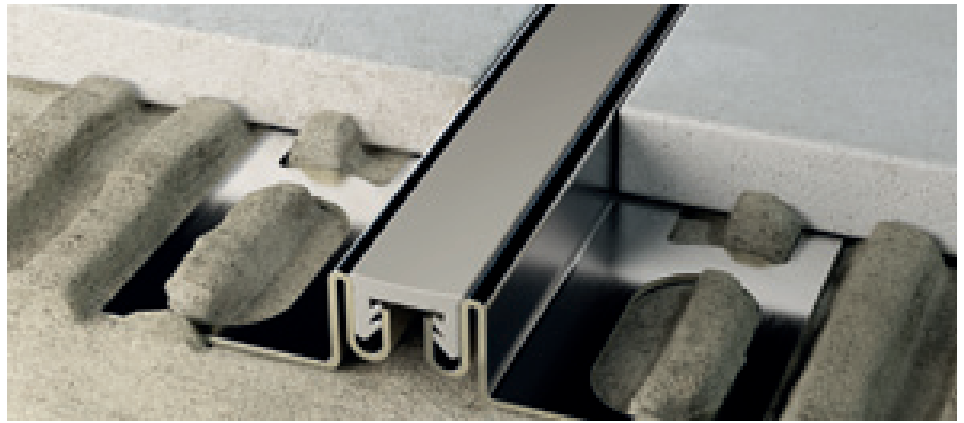

NIN/10 stainless steel + stone grey rubber

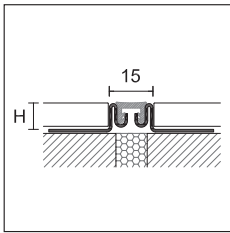

NIN/

**PROJOINT DIL**

length = 270 cm - pack 5 pcs

		H			
ART.	finishing	10	12,5	15	20
<b>STAINLESS STEEL</b>					
NIN/	stainless steel AISI 304 DIN 1.4301 + grey RAL 7035 rubber	99915	99916	99917	99918
	stainless steel AISI 304 DIN 1.4301 + stone grey RAL 7030 rubber	99925	99926	99927	99928
<b>euro/m</b>		<b>26,44</b>	<b>27,28</b>	<b>28,09</b>	<b>29,77</b>

individually packed - NIN/ available with black rubber upon request, minimum order 100 pcs

**SPARE INSERT FOR NIN/**

length= 270 cm - pack 20 pcs

ART.	finishing		
GM/10	grey RAL 7035		99998
	stone grey RAL 7030		99999
<b>euro/m</b>			<b>3,02</b>

Projoint DIL NIL/ is a perimeter expansion joint in stainless steel, with an interchangeable insert in elastic vinyl resin, characterized by a visible section of 14 mm. The structure of the joint allows to connect the floor to the wall and is able to withstand heavy traffic, both pedestrian and vehicular (forklifts, transpallets and cars).



NIL/10 stainless steel + stone grey rubber

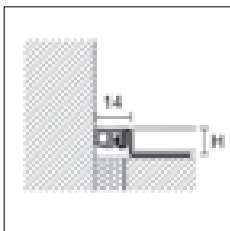

NIL/

**NEW PROJOINT DIL**

length = 270 cm - pack 5 pcs

		H			
ART.	finishing	10	12,5	15	20
<b>STAINLESS STEEL</b>					
NIL/	stainless steel AISI 304 DIN 1.4301 + stone grey RAL 7030 rubber	99896	99897	99898	99899
	<b>euro/m</b>	<b>18,18</b>	<b>18,93</b>	<b>19,82</b>	<b>21,47</b>

individually packed - NIL/ available with black rubber upon request, minimum order 100 pcs

**SPARE INSERT FOR NIL/**

length= 270 cm - pack 20 pcs

ART.	finishing		
GM12/L	stone grey RAL 7030		99987
<b>euro/m</b>			<b>3,02</b>

Complete the article code with H measure (for example NIN/ for H=10 becomes NIN/10)

For a single piece, see sales conditions on page 288

Projoint NTA/, NTI/ and NTO/ are expansion joints for the laying with glue with inner section in vulcanized EPDM. The metal structure easily stands up to the recurring pedestrian and vehicular traffic (forklift trucks, transpallets and cars).



NTA/10 natural aluminium + EPDM grey polishable RAL 7046

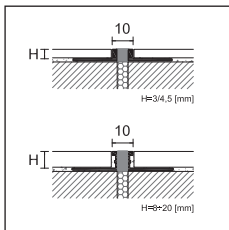

NTA/  
NTO/

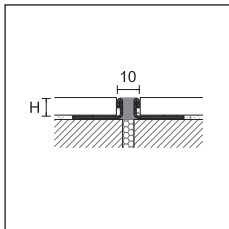

NTI/

Projoint STA/ and STI/ are expansion joints for the division of floors laid with mortar, with inner section in vulcanized EPDM. The metal structure easily withstands the recurring pedestrian and vehicular traffic (forklift trucks, transpallets and cars), making them particularly suitable for shopping malls and frequent passage of loads. We suggest the use of the stainless steel hooks ST/7 for the installation.

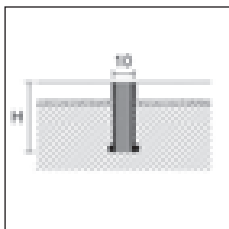

STA/  
STI/

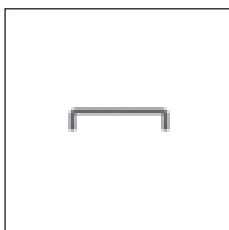

ST/7

### PROJOINT DIL

length = 270 cm - pack 10 pcs

ART.	finishing	3	4,5	8	10	12,5	15	20
<b>ALUMINIUM</b>								
<b>NTA/</b>	natural aluminium + EPDM grey polishable RAL 7046	99421	99425	99441	99445	99449	99453	99457
	natural aluminium + EPDM black polishable RAL 9005	99422	99426	99442	99444	99450	99454	99458
	<b>euro/m</b>	<b>21,35</b>	<b>22,14</b>	<b>22,91</b>	<b>23,72</b>	<b>25,20</b>	<b>26,81</b>	<b>30,51</b>
	natural aluminium + EPDM bahama polishable RAL 10070	99427	99428	-	-	-	-	-
natural aluminium + EPDM brown polishable RAL 10071	99429	99430	-	-	-	-	-	
<b>euro/m</b>	<b>21,35</b>	<b>22,14</b>	-	-	-	-	-	
<b>STAINLESS STEEL</b>								
<b>NTI/</b>	stainless steel AISI 304 DIN 1.4301 + EPDM grey RAL 7046	99471	99475	99481	99485	99489	99493	99497
	stainless steel AISI 304 DIN 1.4301 + EPDM black RAL 9005	99472	99474	99482	99486	99490	-	-
	<b>euro/m</b>	<b>32,84</b>	<b>33,27</b>	<b>34,88</b>	<b>36,76</b>	<b>39,33</b>	<b>42,06</b>	<b>47,76</b>
	stainless steel AISI 304 DIN 1.4301 + EPDM bahama RAL 10070	99431	99432	-	-	-	-	-
stainless steel AISI 304 DIN 1.4301 + EPDM brown RAL 10071	99433	99434	-	-	-	-	-	
<b>euro/m</b>	<b>32,84</b>	<b>33,27</b>	-	-	-	-	-	
<b>STAINLESS STEEL</b>								
<b>NTO/</b>	brass natural + EPDM grey polishable RAL 7046	-	-	99401	99405	99409	99413	99417
<b>euro/m</b>	-	-	<b>39,19</b>	<b>41,69</b>	<b>44,77</b>	<b>48,12</b>	<b>55,02</b>	

art. NTO/15 and NTO/20 pack 5 pcs

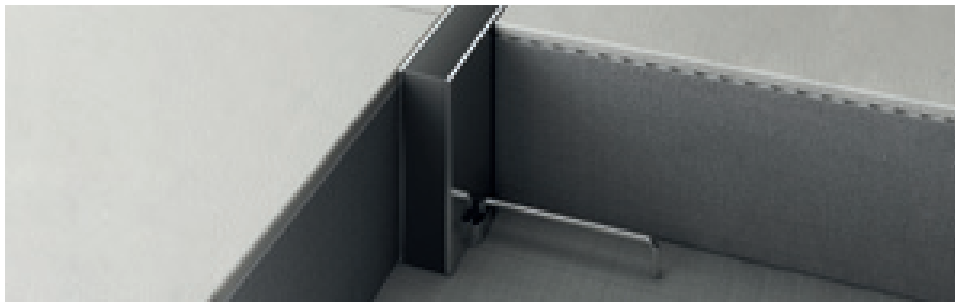

STI/40 stainless steel AISI 304 DIN 1.4301 + EPDM grey polishable RAL 7046

### PROJOINT DIL

length = 250 cm - pack 10 pcs

ART.	finishing	30	40	50
<b>ALUMINIUM</b>				
<b>STA/</b>	natural aluminium + EPDM grey polishable RAL 7046	99581	99585	99589
	<b>euro/m</b>	<b>42,35</b>	<b>52,40</b>	<b>62,43</b>
<b>STAINLESS STEEL</b>				
<b>STI/</b>	stainless steel AISI 304 DIN 1.4301 + EPDM grey polishable RAL 7046	99621	99625	99629
	<b>euro/m</b>	<b>50,86</b>	<b>58,37</b>	<b>69,65</b>

Upon request, we can make different measures and colours for articles STA/, STI/ and STO. Please contact our sales department

### ACCESSORIES

pack 100 pcs

ART.	finishing	
<b>STAINLESS STEEL</b>		
<b>ST/7</b>	steel hook for STA/ and STI/ profiles	99640
<b>euro/pc (euro/pack)</b>		<b>0,64 (64,00)</b>

no partial packaging

Projoint NZA is an expansion joint in aluminium consisting of two interlocking and sliding profiles. Suitable for ceramic floors subjected to intense traffic, it ensures a high resistance to loads and high traffic both pedestrian and vehicular (forklifts, transpallet and cars).



NZA/10 natural aluminium

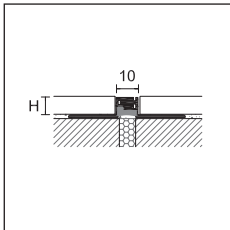

NZA/

**PROJOINT DIL**

length = 270 cm - pack 20 pcs

		H				
ART.	finishing	3	5	8	10	12,5
<b>ALUMINIUM</b>						
NZA/	natural aluminium	-	-	99910	99912	99914
	euro/m	-	-	13,60	13,99	14,40
NZA/	silver anodised	99300	99320	-	-	-
	euro/m	15,33	15,72	-	-	-

individually packed

Projoint NZS is an expansion joint in aluminium with high absorption. Thanks to the 2 interlocking parts, the joint can absorb movements of +/- 5 mm with articulated flins that permit tridimensional movements. The structure of the joint protects the edge of the tile, and it bears the pedestrian and vehicular passage. NZS is also available as a joint cover (when tiles are already laid), NZS/A, or side joint for industrial buildings, NZS/L.



NZS/10 silver anodised aluminium



NZS/A/40 silver anodised aluminium

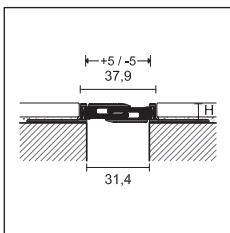

NZS/

**PROJOINT DIL**

length = 270 cm - pack 5 pcs

		H			
ART.	finishing	10	12,5	15	20
<b>ALUMINIUM</b>					
NZS/	silver anodised	99880	99881	99882	99883
	euro/m	35,90	36,34	36,75	37,61

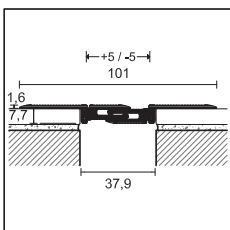

NZS/A/40

**PROJOINT DIL**

length = 270 cm - pack 5 pcs

		H
ART.	finishing	8
<b>ALUMINIUM</b>		
NZS/A/40	silver anodised	99885
	euro/m	35,90

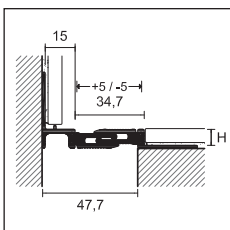

NZS/L/

**PROJOINT DIL**

length = 270 cm - pack 5 pcs

		H			
ART.	finishing	10	12,5	15	20
<b>ALUMINIUM</b>					
NZS/L/	silver anodised	99890	99891	99892	99893
	euro/m	35,90	36,34	36,75	37,61

Complete the article code with H measure (for example NZA/ for H=8 becomes NZA/8)

For a single piece, see sales conditions on page 288

## cerfix® projoint

Projoint DIL PBE is a structural joint composed of two L-shaped profiles in natural aluminium and an expanding part in interchangeable plasticized PVC, available in black or grey. The two L-shaped profiles have drilled bases to allow the mechanical fixing with screws to the underlying structure.



PBE/30 natural aluminium + striated black rubber

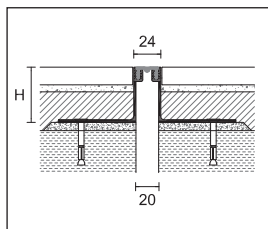

PBE/20 smooth rubber

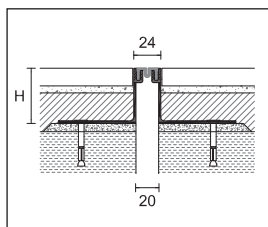

PBE/20 striated rubber

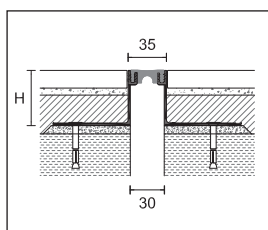

PBE/30 smooth rubber

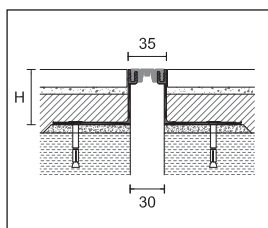

PBE/30 striated rubber

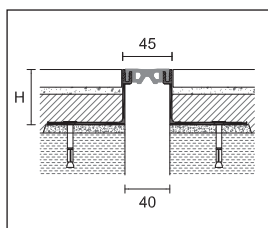

PBE/40 smooth rubber

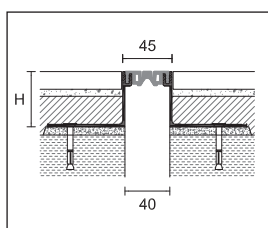

PBE/40 striated rubber

### PROJOINT DIL

length = 300 cm - pack 5 pcs

ART.	finishing	14	24	42	50	82
<b>ALUMINIUM</b>						
	natural aluminium + smooth grey rubber	99321	99322	99323	99324	99325
	natural aluminium + smooth black rubber	99326	99327	99328	99329	99330
<b>PBE/20/</b>	<b>euro/m</b>	<b>35,39</b>	<b>36,72</b>	<b>44,70</b>	<b>55,37</b>	<b>66,31</b>
	natural aluminium + striated grey rubber	99331	99332	99333	99334	99335
	natural aluminium + striated black rubber	99336	99337	99338	99339	99340
	<b>euro/m</b>	<b>35,39</b>	<b>36,72</b>	<b>44,70</b>	<b>55,37</b>	<b>66,31</b>

no partial packaging - profiles are provided with accessories for mechanical fixing



smooth rubber



striated rubber

### PROJOINT DIL

length = 300 cm - pack 5 pcs

ART.	finishing	14	24	42	50	82
<b>ALUMINIUM</b>						
	natural aluminium + smooth grey rubber	99341	99342	99343	99344	99345
	natural aluminium + smooth black rubber	99346	99347	99348	99349	99350
<b>PBE/30/</b>	<b>euro/m</b>	<b>38,57</b>	<b>40,43</b>	<b>48,29</b>	<b>58,31</b>	<b>69,37</b>
	natural aluminium + striated grey rubber	99351	99352	99353	99354	99355
	natural aluminium + striated black rubber	99356	99357	99358	99359	99360
	<b>euro/m</b>	<b>38,57</b>	<b>40,43</b>	<b>48,29</b>	<b>58,31</b>	<b>69,37</b>

no partial packaging - profiles are provided with accessories for mechanical fixing



smooth rubber



striated rubber

### PROJOINT DIL

length = 300 cm - pack 5 pcs

ART.	finishing	14	24	42	50	82
<b>ALUMINIUM</b>						
	natural aluminium + smooth grey rubber	99361	99362	99363	99364	99365
	natural aluminium + smooth black rubber	99366	99367	99368	99369	99370
<b>PBE/40/</b>	<b>euro/m</b>	<b>41,36</b>	<b>42,69</b>	<b>50,43</b>	<b>56,70</b>	<b>72,57</b>
	natural aluminium + striated grey rubber	99371	99372	99373	99374	99375
	natural aluminium + striated black rubber	99376	99377	99378	99379	99380
	<b>euro/m</b>	<b>41,36</b>	<b>42,69</b>	<b>50,43</b>	<b>56,70</b>	<b>72,57</b>

no partial packaging - profiles are provided with accessories for mechanical fixing



smooth rubber



striated rubber

We suggest the use of the black insert.

Delivery times to be agreed.



Projoint DIL PBH and PAS are two structural joints composed of two L-shaped profiles in natural aluminium and an expanding part in interchangeable EPDM, available in black or grey. Projoint DIL PHDE is a structural joint composed of two interlocking and sliding profiles in natural aluminium. All profiles have drilled bases to allow the mechanical fixing with screws to the underlying structure and are designed to withstand structural movements of big buildings.

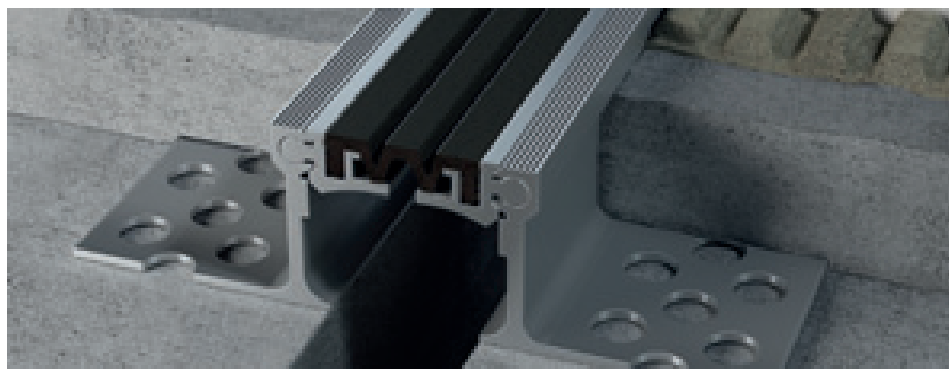

PBH/65/ natural aluminium + black EPDM insert

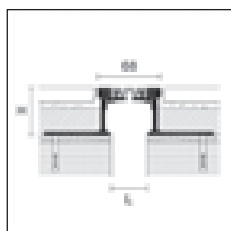

PBH/65

**PROJOINT DIL**

length = 300 cm - pack 2 pcs

		H			
ART.	finishing	18	35	50	80
<b>ALUMINIUM</b>		<b>L=50</b>	<b>L=40</b>	<b>L=40</b>	<b>L=40</b>
<b>PBH/65/</b>	natural aluminium + grey EPDM insert	99500	99501	99502	99503
	natural aluminium + black EPDM insert	99504	99505	99506	99507
<b>euro/m</b>		<b>86,72</b>	<b>97,52</b>	<b>118,46</b>	<b>154,75</b>

no partial packaging - profiles are provided with accessories for mechanical fixing

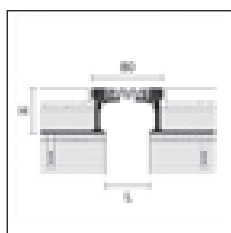

PBH/75

**PROJOINT DIL**

length = 300 cm - pack 2 pcs

		H			
ART.	finishing	18	35	50	80
<b>ALUMINIUM</b>		<b>L=60</b>	<b>L=50</b>	<b>L=50</b>	<b>L=50</b>
<b>PBH/75/</b>	natural aluminium + grey EPDM insert	99508	99509	99510	99511
	natural aluminium + black EPDM insert	99512	99513	99514	99515
<b>euro/m</b>		<b>96,05</b>	<b>109,39</b>	<b>127,01</b>	<b>170,75</b>

no partial packaging - profiles are provided with accessories for mechanical fixing

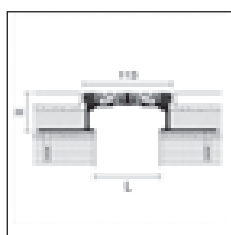

PAS/105

**PROJOINT DIL**

length = 300 cm - pack 2 pcs

		H			
ART.	finishing	18	35	50	80
<b>ALUMINIUM</b>		<b>L=95</b>	<b>L=85</b>	<b>L=85</b>	<b>L=85</b>
<b>PAS/105/</b>	natural aluminium + grey EPDM insert	99516	99517	99518	99519
	natural aluminium + black EPDM insert	99520	99521	99522	99523
<b>euro/m</b>		<b>150,75</b>	<b>164,09</b>	<b>172,50</b>	<b>216,11</b>

no partial packaging - profiles are provided with accessories for mechanical fixing

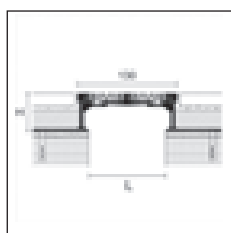

PAS/125

**PROJOINT DIL**

length = 300 cm - pack 2 pcs

		H			
ART.	finishing	18	35	50	80
<b>ALUMINIUM</b>		<b>L=111</b>	<b>L=100</b>	<b>L=100</b>	<b>L=100</b>
<b>PAS/125/</b>	natural aluminium + grey EPDM insert	99524	99525	99526	99527
	natural aluminium + black EPDM insert	99528	99529	99530	99531
<b>euro/m</b>		<b>166,48</b>	<b>181,03</b>	<b>210,78</b>	<b>240,92</b>

no partial packaging - profiles are provided with accessories for mechanical fixing

We suggest the use of the black insert.

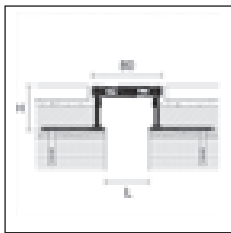

PHDE/80

**PROJOINT DIL**

length = 300 cm - pack 2 pcs		H			
ART.	finishing	18	35	50	80
<b>ALUMINIUM</b>		L=60	L=50	L=50	L=50
PHDE/80/	natural aluminium	99590	99591	99592	99593
	euro/m	118,46	145,14	181,43	222,24

no partial packaging - profiles are provided with accessories for mechanical fixing

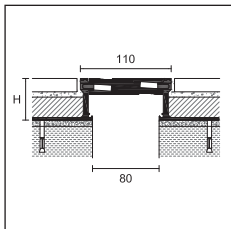

PHDE/110

**PROJOINT DIL**

length = 300 cm - pack 2 pcs		H	
ART.	finishing	50	80
<b>ALUMINIUM</b>			
PHDE/110/	natural aluminium	99594	99595
	euro/m	206,92	238,67

no partial packaging - profiles are provided with accessories for mechanical fixing

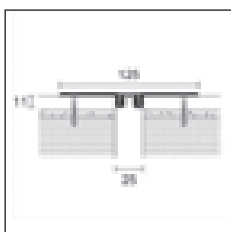

PFFE/20

**PROJOINT DIL**

length = 300 cm - pack 5 pcs		H	
ART.	finishing		
<b>ALUMINIUM</b>			
	natural aluminium + smooth grey rubber	99596	
	natural aluminium + smooth black rubber	99597	
PFFE/20/	euro/m	32,29	
	natural aluminium + striated grey rubber	99598	
	natural aluminium + striated black rubber	99599	
	euro/m	32,29	

no partial packaging - profiles are provided with accessories for mechanical fixing



smooth rubber    striated rubber

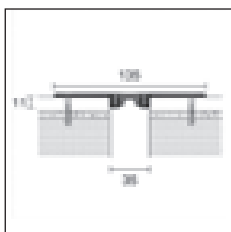

PFFE/30

**PROJOINT DIL**

length = 300 cm - pack 5 pcs		H	
ART.	finishing		
<b>ALUMINIUM</b>			
	natural aluminium + smooth grey rubber	99600	
	natural aluminium + smooth black rubber	99601	
PFFE/30/	euro/m	39,10	
	natural aluminium + striated grey rubber	99602	
	natural aluminium + striated black rubber	99603	
	euro/m	39,10	

no partial packaging - profiles are provided with accessories for mechanical fixing



smooth rubber    striated rubber

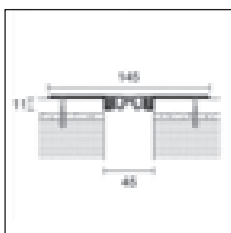

PFFE/40

**PROJOINT DIL**

length = 300 cm - pack 5 pcs		H	
ART.	finishing		
<b>ALUMINIUM</b>			
	natural aluminium + smooth grey rubber	99604	
	natural aluminium + smooth black rubber	99605	
PFFE/40/	euro/m	43,63	
	natural aluminium + striated grey rubber	99606	
	natural aluminium + striated black rubber	99607	
	euro/m	43,63	

no partial packaging - profiles are provided with accessories for mechanical fixing



smooth rubber    striated rubber

Procover Flex is a line of structural aluminium joint covers designed to withstand traction and compression transverse movements of large buildings.

They withstand both pedestrian and vehicular traffic with rubber wheels (cars).

Procover Fix is a line of flat joint cover profiles in aluminium for coplanar floors (GJA/) and perimeter joint cover profiles for the connection of floors and walls (GWA/), suitable to cover structural movements of expansion or compression of two different structures.

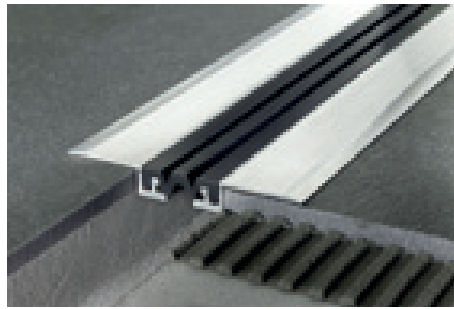

GJF/40 natural aluminium + EPDM black RAL 9005

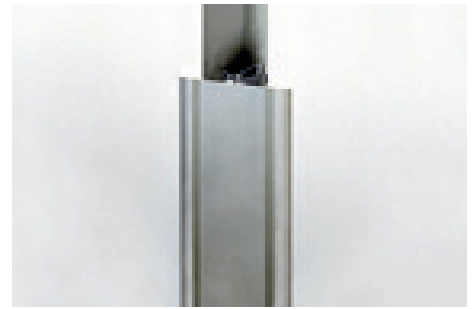

GJA/70 silver anodised aluminium

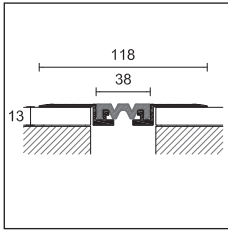

GJF/40

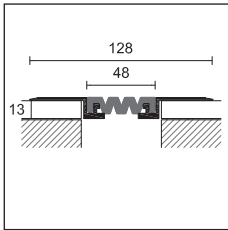

GJF/50

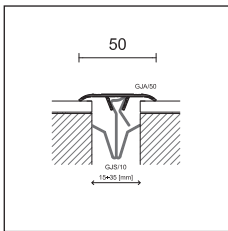

GJA/50

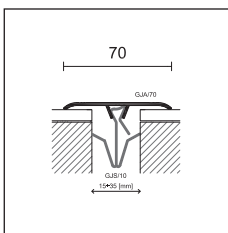

GJA/70

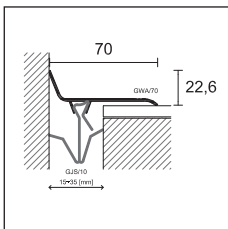

GWA/70

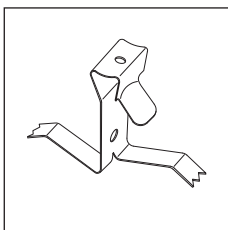

GJS/10

**PROCOVER FLEX**

length = 400 cm - pack 5 pcs

L

ART.	finishing	40	50
<b>ALUMINIUM</b>			
GJF/	natural aluminium + EPDM black insert RAL 9005	74490	74492
	euro/m	34,84	37,80

**SPARE INSERT**

length = 400 cm

L

ART.	finishing	40	50
<b>ALUMINIUM</b>			
GM/	EPDM black RAL 9005	74491	74493
	euro/m	11,20	14,70

**PROCOVER FIX**

length = 300 cm - pack 10 pcs

L

ART.	finishing	50	70
<b>ALUMINIUM</b>			
GJA/	silver anodised	74550	74610
	euro/m	16,21	28,08
GWA/	silver anodised	-	74552
	euro/m	-	25,17

**SPRING CLIP**

from 15 to 35 mm - pack 50 pcs

**STAINLESS STEEL**

GJS/10	harmonic stainless steel	74730
	euro/pc	2,31

Complete the article code with L measure (for example GJF/ for L=40 becomes GJF/40)

For a single piece, see sales conditions on page 288

## cerfix® procover

Procover G in anodized aluminium are joint covering profiles, suitable for creating continuity on structures with continuous bays. These joint coverings are supplied with adhesive or are fixed with screws and dowels.

In this case it is perforated laterally, and fixed only to one structure allowing the free sliding over the other.



G/80/A silver anodised aluminium

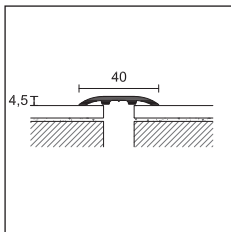

G/40/

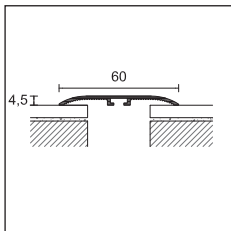

G/60/

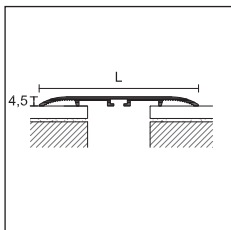

G/80/

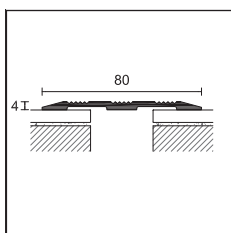



GR/80/SF

Complete the article code with A-AD=adhesive, SF=undrilled (for example G/40/ adhesive becomes G/40/A)

 packaging in blister no partial packaging

For a single piece, see sales conditions on page 288

### PROCOVER

pack	20 pcs	20 pcs	 6 pcs / blister	20 pcs		
length cm	300	300	100	300		
ART.	G/40/	G/60/	G/460/	G/80/		
finishing	A	SF	A	AD	SF	A
<b>ALUMINIUM</b>						
silver anodised	 74528	74558	74588	21982	74618	74648
euro/m	8,88	9,67	11,58	-	12,86	14,81
euro/pc	-	-	-	13,14	-	-

art. G/40, G/60 and G/80 individually packed

### PROCOVER

length = 270 cm - pack 10 pcs	L
width	80
ART.	GR/80/
finishing	SF
<b>ALUMINIUM</b>	
silver anodised	 71855
euro/m	16,20

individually packed



GR/80/SF silver anodised aluminium

Procover G in stainless steel and polished brass are joint covering profiles, suitable for creating continuity on structures with continuous bays. These joint coverings are supplied with adhesive or are fixed with screws and dowels. In this case it is perforated laterally, and fixed only to one structure allowing the free sliding over the other. In these versions they are suitable even to vehicular traffic.

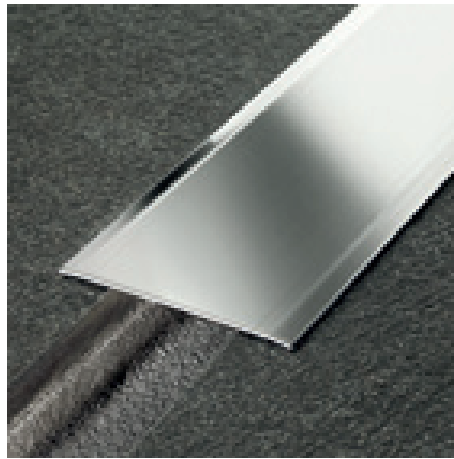

760/SF polished stainless steel AISI430-DIN 1.4016

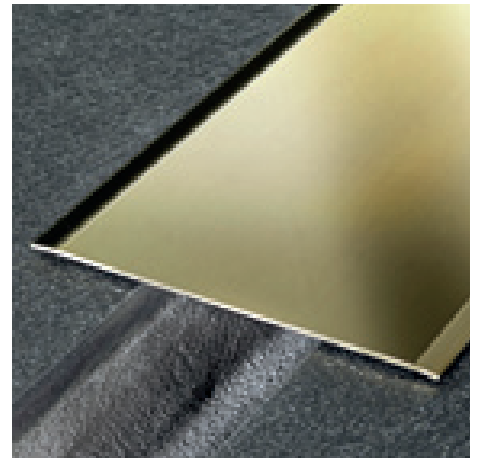

0100/A polished brass

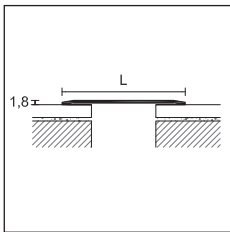

**PROCOVER**

pack	10 pcs	6 pcs / blister	10 pcs	6 pcs / blister	5 pcs	3 pcs / blister	5 pcs
length cm	300	100	300	100	300	100	300
width mm	50	50	60	60	80	80	100
thickness	12/10						
ART.	750/	4750/	760/	4760/	780/	4780/	7100/
finishing	SF A	AD	SF A	AD	SF A	AD	SF A

**STAINLESS STEEL**

polished stainless steel AISI 430 - DIN 1.4016	74818	74828	22090	74838	74848	40531	74858	74868	40553	74878	74888
euro/m	13,24	15,52	-	16,20	18,48	-	21,05	23,31	-	24,75	27,02
euro/pc	-	-	17,26	-	-	20,31	-	-	25,21	-	-

art. 750/, 760/, 780/, 7100/ individually packed

**PROCOVER**

pack	10 pcs	6 pcs / blister	5 pcs	6 pcs / blister	5 pcs	3 pcs / blister	5 pcs.
length cm	300	100	300	100	300	100	300
width mm	50	50	60	60	80	80	100
thickness	13/10						
ART.	050/	4050/	060/	4060/	080/	4080/	0100/
finishing	SF A	AD	SF A	AD	SF A	AD	SF A

**STAINLESS STEEL**

polished	74738	74748	22050	74758	74768	40504	-	74788	40512	74798	74808
euro/m	25,02	27,89	-	30,41	33,32	-	-	42,23	-	47,17	50,10
euro/pc	-	-	30,03	-	-	35,46	-	-	44,37	-	-

art. 050/, 060/, 080/, 0100/ individually packed

Complete the article code with A-AD=adhesive, SF=undrilled (eg. 050/ adhesive becomes 050/A)

 packaging in blister no partial packaging

For a single piece, see sales conditions on page 288





## waterproofing, drainage, uncoupling

A line of waterproofing, uncoupling and draining membranes for the laying of ceramic floors and coverings of bathrooms, balconies, terraces and problematic supports.

## wpstop

WPstop is a waterproof membrane in polyethylene with a textile in polypropylene in both sides in order to facilitate the grip of the adhesive, thus ensuring a high adhesion to the support. It is particularly suitable for the waterproofing of floors and tiled walls of bathrooms. PAIG/ are special pre-formed pieces for waterproofing the internal corners of floor-level showers using Glass Profile GPS1 and GPS3.

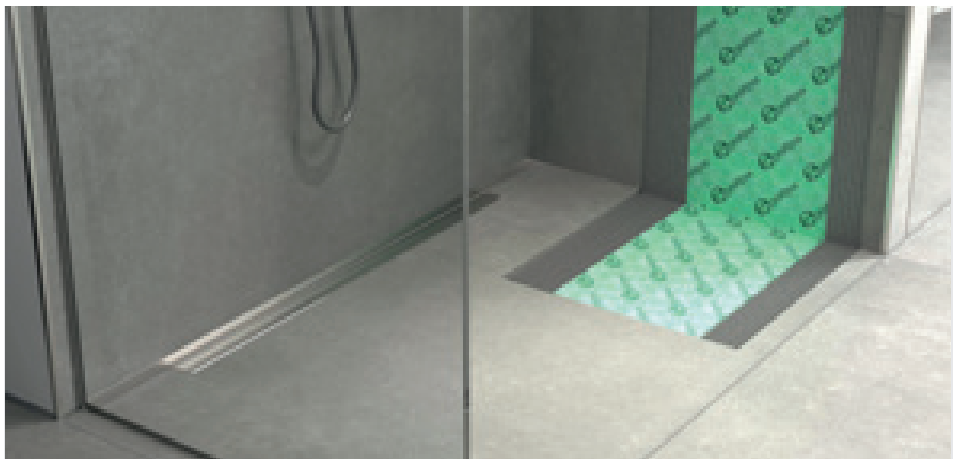

WPstop system



rolls and stripes

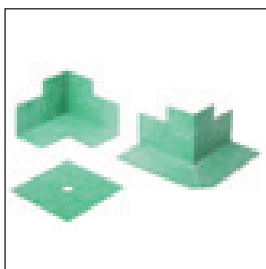

corners and colar

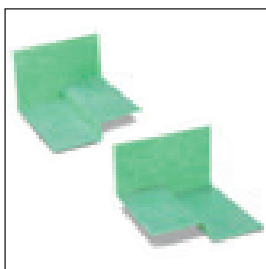

PAIG/DX/  
PAIG/SX/

### WPSTOP

ART.	measures	
<b>PR30</b>	roll 1 m height 30 mt length - pack 1 roll	19900
	<i>euro/m</i>	<b>10,37</b>
<b>PR5</b>	roll 1 m height 5 mt length - pack 6 rolls	19902
	<i>euro/m</i>	<b>12,16</b>
<b>PB30</b>	stripe 14 cm height 30 mt length - pack 1 roll	19910
	<i>euro/m</i>	<b>3,18</b>
<b>PB5</b>	stripe 14 cm height 5 mt length - pack 6 rolls	19912
	<i>euro/m</i>	<b>4,12</b>
<b>PAE</b>	outside corners - pack 10 pcs	19920
	<i>euro/pc</i>	<b>7,65</b>
<b>PAI</b>	inside corners - pack 10 pcs	19922
	<i>euro/pc</i>	<b>7,65</b>
<b>PF12</b>	colar cm 12x12 - pack 10 pcs	19930
	<i>euro/pc</i>	<b>5,95</b>

no partial packaging

### NEW WPSTOP - CORNERS FOR GLASS PROFILE GPS1 AND GPS3

ART.	measures	DX	SX
<b>PAIG/15</b>	inside corners - pack 10 pcs	19931	19932
	<i>euro/pc (euro/pack)</i>	<b>14,31 (143,10)</b>	<b>14,31 (143,10)</b>
<b>PAIG/20</b>	inside corners - pack 10 pcs	19933	19934
	<i>euro/pc (euro/pack)</i>	<b>14,31 (143,10)</b>	<b>14,31 (143,10)</b>
<b>PAIG/28</b>	inside corners - pack 10 pcs	19935	19936
	<i>euro/pc (euro/pack)</i>	<b>14,31 (143,10)</b>	<b>14,31 (143,10)</b>
<b>PAIG/38</b>	inside corners - pack 10 pcs	19937	19938
	<i>euro/pc (euro/pack)</i>	<b>14,31 (143,10)</b>	<b>14,31 (143,10)</b>

no partial packaging

### INSTRUCTIONS

Store in a cool and dry place, avoiding direct exposure to sunlight and heat sources.

Please refer to the technical data sheet before the installation. For special installations, please contact our technical department.

For a single piece, see sales conditions on page 288



WPstop 3 is an uncoupling, waterproofing and anti-fracture membrane for indoor and outdoor use, particularly recommended before the laying of floors of bathrooms, balconies, terraces and problematic supports. WPstop Drain 10 is a draining membrane in high-density polyethylene (HDPE) with truncated cones structure and a filtering permeable fabric on the upper side. WPstop Drain 10 complies with the regulation UNI 11493-1 which requires a protective draining layer in case of waterproofing under the screed.



WPstop 3



PWP30

**WPSTOP 3**

**ART. measures**

<b>PWP30</b>	roll 1 m height 30 mt length - pack 8 rolls	19940
	<i>euro/m</i>	<b>15,71</b>
<b>PBE30</b>	elastic stripe of 12 cm height and 30 m length - pack 1 roll	19945
	<i>euro/m</i>	<b>4,31</b>
<b>PBE5</b>	elastic stripe of 12 cm height and 5 m length - pack 6 rolls	19946
	<i>euro/m</i>	<b>5,22</b>

no partial packaging for PBE30 and PBE5

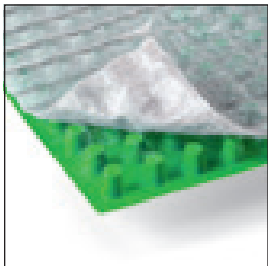

PWD12

**WPSTOP DRAIN 10**

**ART. measures**

<b>PWD12</b>	roll of 0,96 m height and 12,5 m length - pack 6 rolls	19950
	<i>euro/m</i>	<b>13,60</b>

**INSTRUCTIONS**

Store in a cool and dry place, avoiding direct exposure to sunlight and heat sources. Please refer to the technical data sheet before the installation. For special installations, please contact our technical department.

**MS POLYMER-BASED ADHESIVE**

pack 24 pcs - quantity 290 ml

**ART. measures**

<b>PP/96</b>		78301
	<i>euro/pc</i>	<b>18,81</b>



WPstop3 - uncoupling

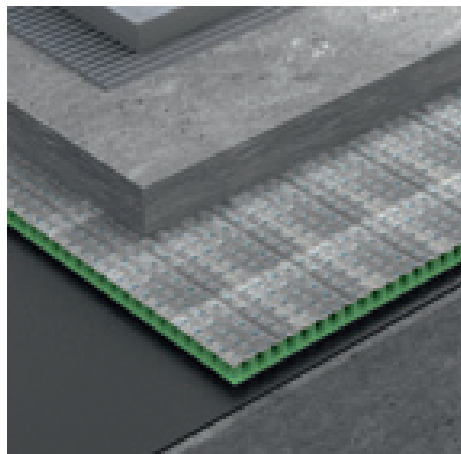

WPstop Drain 10

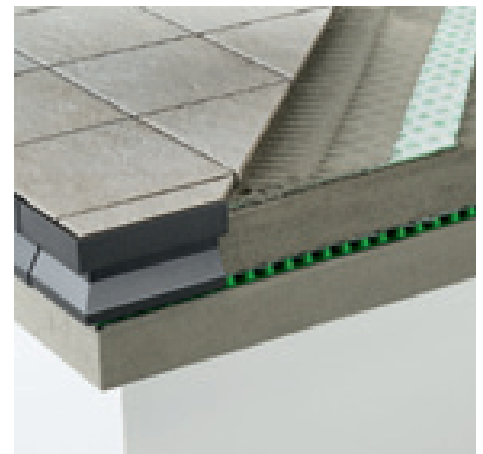

WPstop3 + WPstop3 drain 10



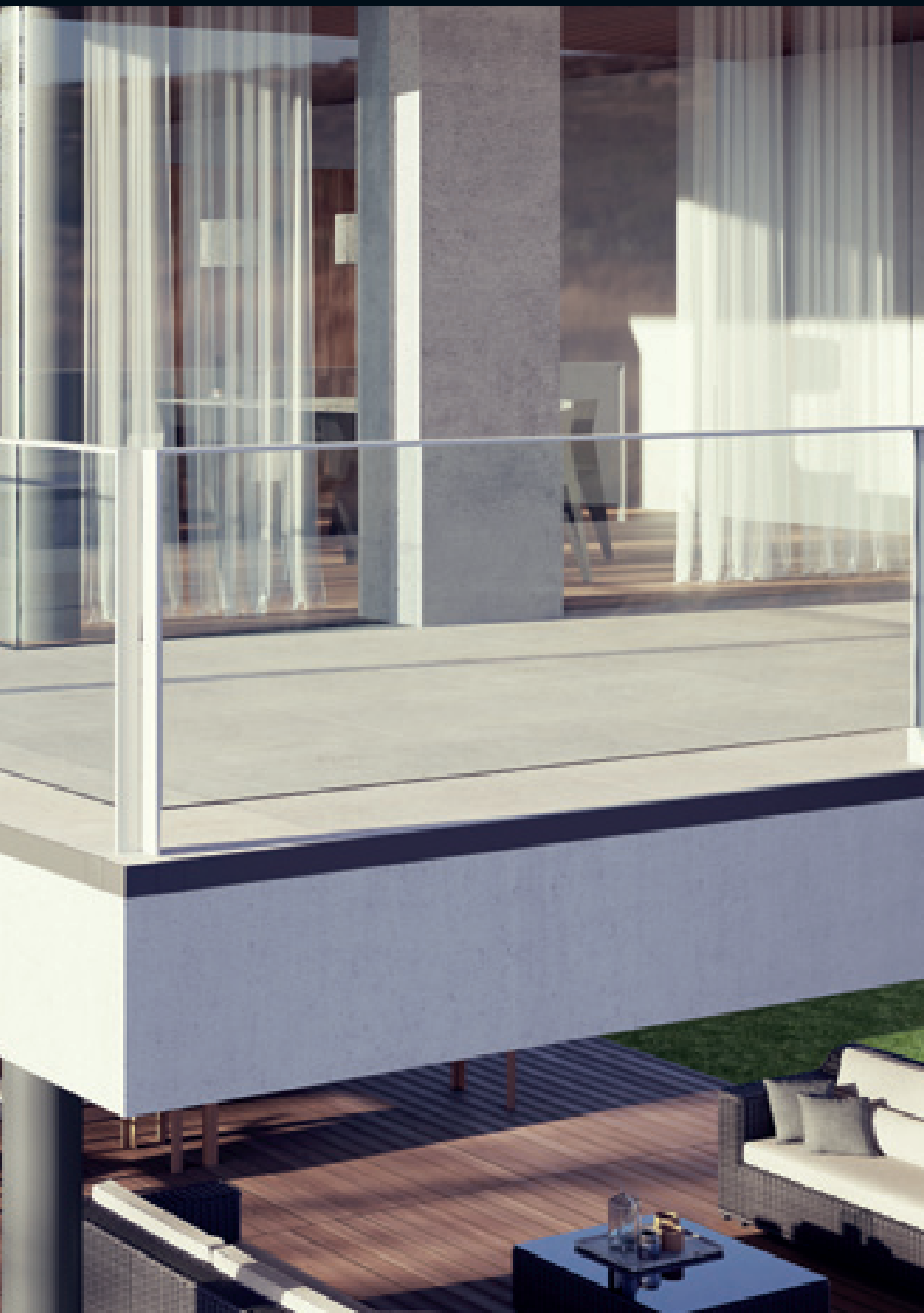

## profiles for balconies and terraces

A functional and stylish line for the protection of terraces, balconies and pavements. The effectiveness of the protection decorates and completes every architectural detail.

Protec CPCV and CPCI are a series of edge profiles for the protection and the finishing of the outside edges of terraces and balconies. Available in colour-coated aluminium and stainless steel, they have been designed with a protruding section and can be used with tiles thicknesses up to 21 mm. In addition to protecting and finishing the outside edges, they guarantee the outflow of water from the floor, avoiding the contact with the outside border.

Protec CPCV is also available in the bendable version CPCVF, provided with a special cutout that allows to bend the profile with a radius up to 1 meter.

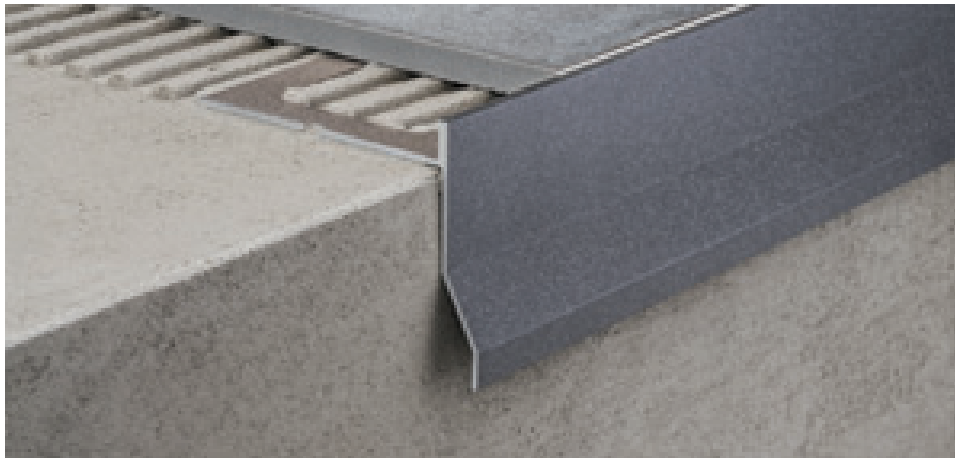

CPCV/55/10 ancient grey colour-coated aluminium

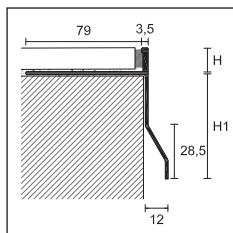

CPCV/

**PROTEC**

length = 270 cm - pack 10 pcs

ART.	H									
	10	12,5	21	10	12,5	21	10	12,5	21	
<b>finishing</b>	CPCV/55/			CPCV/75/			CPCV/95/			
<b>COLOUR-COATED ALUMINIUM</b>										
white RAL 9003	□	87677	87678	-	87687	87688	-	87697	87698	-
ash grey RAL 7038	■	87681	87682	87660	87691	87692	87661	87701	87702	87662
ash grey RAL 7038 embossed	■	87713	87714	-	87715	87716	-	87717	87718	-
dark brown RAL 8019	■	87683	87684	-	87693	87694	-	87703	87704	-
rust	■	87616	87617	-	87618	87619	-	-	-	-
metal grey RAL 9006	■	87720	87721	-	87723	87724	-	87726	87727	-
aluminium grey RAL 9007	■	87750	87751	-	87753	87754	-	87756	87757	-
ancient grey	■	87707	87708	-	87709	87710	-	87711	87712	-
<b>euro/m</b>		<b>19,57</b>	<b>19,57</b>	<b>23,42</b>	<b>22,09</b>	<b>22,09</b>	<b>25,95</b>	<b>25,21</b>	<b>25,21</b>	<b>29,07</b>

For colours on request please contact our sales department

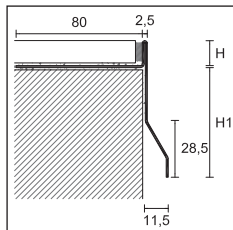

CPCI/

**PROTEC**

length = 270 cm - pack 10 pcs

ART.	H									
	10	12,5	10	12,5	10	12,5				
<b>finishing</b>	CPCI/55/		CPCI/75/		CPCI/95/					
<b>STAINLESS STEEL</b>										
polished stainless steel AISI 304 DIN 1.4301	■	87671	87672	-	87673	87674	-	87675	87676	-
<b>euro/m</b>		<b>32,07</b>	<b>32,29</b>	-	<b>35,82</b>	<b>36,06</b>	-	<b>39,89</b>	<b>40,15</b>	-

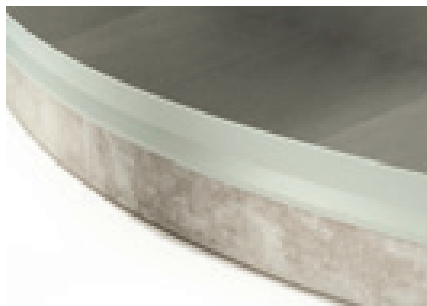

CPCVF/55/10 ash grey RAL 7038 embossed colour-coated aluminium

Complete the article code with H measure (for example CPCV/55/ for H=10 becomes CPCV/55/10)

**PROTEC FLEX PRO FLEX LINE**

length = 270 cm - pack 2 pcs

ART.	H		
	10	<b>NEW</b> 12,5	
<b>finishing</b>	CPCVF/55/		
<b>COLOUR-COATED ALUMINIUM</b>			
ash grey RAL 7038	■	87790	-
ash grey RAL 7038 embossed	■	87791	87793
ancient grey	■	87792	87794
<b>euro/m</b>		<b>26,22</b>	<b>26,22</b>

no partial packaging

For colours on request and other heights please contact our sales department

For a single piece, see sales conditions on page 288

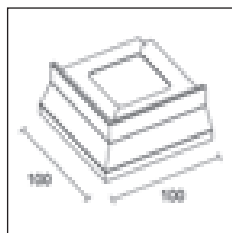

CPCV//E  
CPCI//E

90° OUTSIDE CORNER

pack 5 pcs		H								
		10	12,5	21	10	12,5	21	10	12,5	21
ART.	finishing	CPCV/55/ E			CPCV/75/ E			CPCV/95/ E		
<b>COLOUR-COATED ALUMINIUM</b>										
white RAL 9003		87817	87818	-	87827	87828	-	87837	87838	-
ash grey RAL 7038		87821	87822	87663	87831	87832	87664	87841	87842	87665
ash grey RAL 7038 embossed		87894	87895	-	87896	87897	-	87898	87899	-
dark brown RAL 8019		87825	87826	-	87835	87836	-	87845	87846	-
rust		87620	87621	-	87622	87623	-	-	-	-
metal grey RAL 9006		87730	87731	-	87733	87734	-	87736	87737	-
aluminium grey RAL 9007		87760	87761	-	87763	87764	-	87766	87767	-
ancient grey		87877	87878	-	87879	87880	-	87881	87882	-
<b>euro/pc</b>		<b>28,10</b>	<b>28,10</b>	<b>31,96</b>	<b>28,10</b>	<b>28,10</b>	<b>31,96</b>	<b>28,10</b>	<b>28,10</b>	<b>31,96</b>

90° OUTSIDE CORNER

pack 5 pcs		H					
		10	12,5	10	12,5	10	12,5
ART.	finishing	CPCI/55/ E		CPCI/75/ E		CPCI/95/ E	
<b>STAINLESS STEEL</b>							
polished stainless steel AISI 304 DIN 1.4301		87801	87802	-	87803	87804	-
<b>euro/pc</b>		<b>44,05</b>	<b>44,05</b>	-	<b>44,05</b>	<b>44,05</b>	-

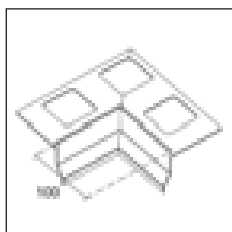

CPCV/55/ I

90° INSIDE CORNER

pack 5 pcs		H		
		10	12,5	
ART.	finishing	CPCV/55/ I		
<b>COLOUR-COATED ALUMINIUM</b>				
ash grey RAL 7038		87890	87891	-
ash grey RAL 7038 embossed		87807	87808	-
ancient grey		87892	87893	-
<b>euro/pc</b>		<b>30,93</b>	<b>30,93</b>	-

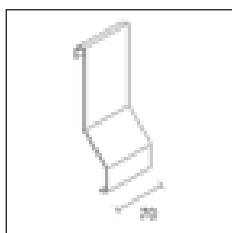

CPCV// G  
CPCI// G

JUNCTION

width = 70 mm - pack 5 pcs		H								
		10	12,5	21	10	12,5	21	10	12,5	21
ART.	finishing	CPCV/55/ G			CPCV/75/ G			CPCV/95/ G		
<b>COLOUR-COATED ALUMINIUM</b>										
white RAL 9003		87847	87848	-	87857	87858	-	87867	87868	-
ash grey RAL 7038		87851	87852	87666	87861	87862	87667	87871	87872	87668
ash grey RAL 7038 embossed		87748	87749	-	87758	87759	-	87768	87769	-
dark brown RAL 8019		87853	87854	-	87863	87864	-	87873	87874	-
rust		87624	87625	-	87626	87627	-	-	-	-
metal grey RAL 9006		87740	87741	-	87743	87744	-	87746	87747	-
aluminium grey RAL 9007		87770	87771	-	87773	87774	-	87776	87777	-
ancient grey		87883	87884	-	87885	87886	-	87887	87888	-
<b>euro/pc</b>		<b>5,46</b>	<b>5,46</b>	<b>8,01</b>	<b>5,46</b>	<b>5,46</b>	<b>8,01</b>	<b>5,46</b>	<b>5,46</b>	<b>8,01</b>

no partial packaging

JUNCTION

width = 70 mm - pack 5 pcs		H					
		10	12,5	10	12,5	10	12,5
ART.	finishing	CPCI/55/ G		CPCI/75/ G		CPCI/95/ G	
<b>STAINLESS STEEL</b>							
polished stainless steel AISI 304 DIN 1.4301		87811	87812	-	87813	87814	-
<b>euro/pc</b>		<b>7,14</b>	<b>7,14</b>	-	<b>7,14</b>	<b>7,14</b>	-

no partial packaging



CPCV/55/E + CPCV/55/G ancient grey colour-coated aluminium

For a single piece, see sales conditions on page 288

BALCONIES AND TERRACES

Protec CPCV/30/ is the solution for old terraces. The reduced dimensions of the protruding section allow to avoid removing the perimetral balustrades in case of refurbishment.



CPCV/30/ ancient grey colour-coated aluminium

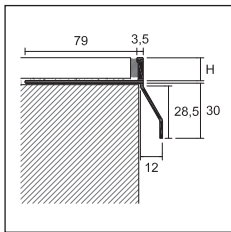

CPCV/30/

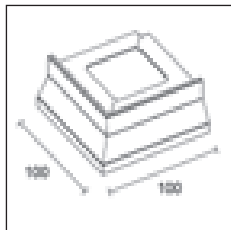

CPCV/30//E

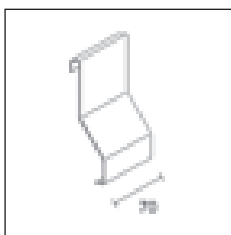

CPCV/30//G

**PROTEC**

length = 270 cm - pack 10 pcs

		H	
		10	12,5
<b>ART.</b>		<b>CPCV/30/10</b>	<b>CPCV/30/12</b>
<b>finishing</b>			
<b>COLOUR-COATED ALUMINIUM</b>			
ash grey RAL 7038		87651	87652
ash grey RAL 7038 embossed		87655	87656
ancient grey		87653	87654
<b>euro/m</b>		<b>13,08</b>	<b>13,47</b>

**90° OUTSIDE CORNER**

pack 5 pcs

		H	
		10	12,5
<b>ART.</b>	<b>finishing</b>	<b>CPCV/30/10/E</b>	<b>CPCV/30/12/E</b>
<b>COLOUR-COATED ALUMINIUM</b>			
ash grey RAL 7038		87780	87781
ash grey RAL 7038 embossed		87784	87785
ancient grey		87782	87783
<b>euro/pc</b>		<b>13,35</b>	<b>13,72</b>

**JUNCTION**

width = 70 mm - pack 5 pcs

		H	
		10	12,5
<b>ART.</b>	<b>finishing</b>	<b>CPCV/30/10/G</b>	<b>CPCV/30/12/G</b>
<b>COLOUR-COATED ALUMINIUM</b>			
ash grey RAL 7038		87631	87632
ash grey RAL 7038 embossed		87635	87636
ancient grey		87633	87634
<b>euro/pc</b>		<b>5,72</b>	<b>5,72</b>

no partial packaging

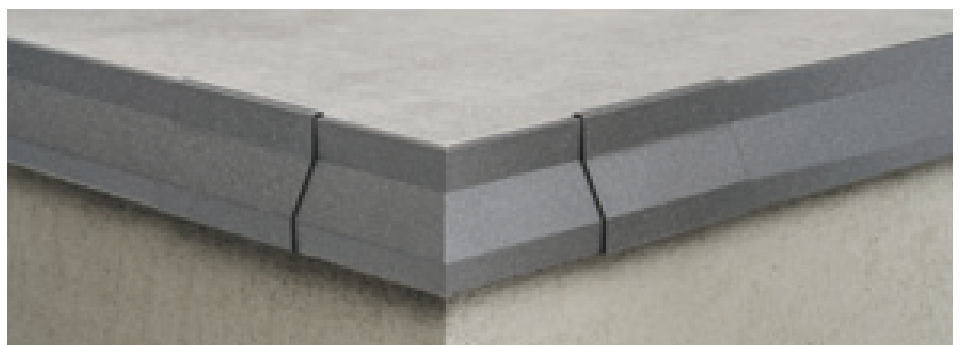

CPCV/30//E ancient grey colour-coated aluminium

Complete the article code with H measure (for example CPCV/30/ for H=10 becomes CPCV/30/10)

For a single piece, see sales conditions on page 288

Protec CPNV is a series of edge profiles for the protection and the finishing of the outside edges of terraces and balconies. Available in colour-coated aluminium, they can be installed flush with the border or detached from it. Their special section makes them suitable for the protection of the borders of steps or sidewalks, since it hides the junction between the tread and the riser. Protec CPNV is also available in the bendable version CPNVF, provided with a special cutout that allows to bend the profile with a radius up to 40 cm.



CPNV/45/ ash grey RAL 7038 embossed colour-coated aluminium

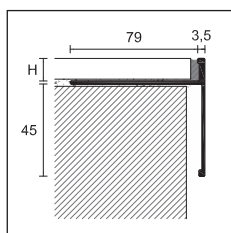

CPNV/45/

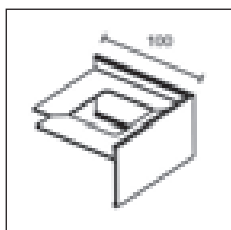

CPNV/45/ /E

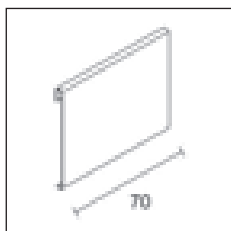

CPNV/45/ /G



CPNVF/45/10 ancient grey colour-coated aluminium

Complete the article code with H measure (for example CPNV/45/ for H=10 becomes CPNV/45/10)

For a single piece, see sales conditions on page 288

**PROTEC**

length = 270 cm - pack 10 pcs H

ART.	finishing	10	11	12,5
------	-----------	----	----	------

**COLOUR-COATED ALUMINIUM**

CPNV/45/	ash grey	■	87270	87271	87272
	RAL 7038 embossed				
	ancient grey	■	87273	87274	87275
	<b>euro/m</b>		<b>16,37</b>	<b>16,50</b>	<b>16,63</b>

white RAL 9003, dark brown RAL 8019, metal grey RAL 9006, aluminium grey RAL 9007, ash grey RAL 7038 and rust with a minimum of 270 meters, on request, without surcharge. For colours on request please contact our sales department.

**90° OUTSIDE CORNER**

pack 5 pcs H

ART.	finishing	10	11	12,5
------	-----------	----	----	------

**COLOUR-COATED ALUMINIUM**

CPNV/45/ /E	ash grey	■	87276	87277	87278
	RAL 7038 embossed				
	ancient grey	■	87279	87280	87281
	<b>euro/pc</b>		<b>19,14</b>	<b>19,14</b>	<b>19,14</b>

**JUNCTION**

width = 70 mm - pack 5 pcs H

ART.	finishing	10	11	12,5
------	-----------	----	----	------

**COLOUR-COATED ALUMINIUM**

CPNV/45/ /G	ash grey	■	87282	87283	87284
	RAL 7038 embossed				
	ancient grey	■	87285	87286	87287
	<b>euro/pc</b>		<b>5,72</b>	<b>5,72</b>	<b>5,72</b>

no partial packaging

**PROTEC FLEX ~~PRO~~ FLEX LINE**

length = 270 cm - pack 2 pcs H

ART.	finishing	10	NEW 12,5
------	-----------	----	----------

**COLOUR-COATED ALUMINIUM**

CPNVF/45/	ash grey	■	87288	87290
	RAL 7038 embossed			
	ancient grey	■	87289	87291
	<b>euro/m</b>		<b>24,09</b>	<b>24,38</b>

no partial packaging

For colours on request and other heights please contact our sales department.

Protec CPGV is a perimetral profile for the protection and finishing of the outside edges of terraces and balconies. This profile is composed of a vertical part that facilitates the outflow of rainwater from the tiled surface and protects the border of the floor, and a sloping part equipped with holes for a further discharge of the water seeped under the tiles. This technical solution and the consequent drainage reduce the problems of freezing and thawing and the unsightly efflorescences on the tiles grouts. It can be used with tiles thicknesses up to 12,5 mm.



CPGV/55/10 ancient grey colour-coated aluminium

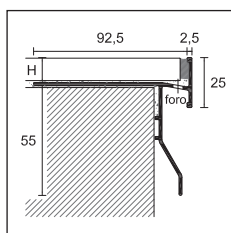

CPGV/55/

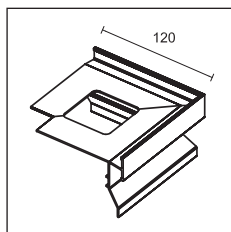

CPGV/55/ /E

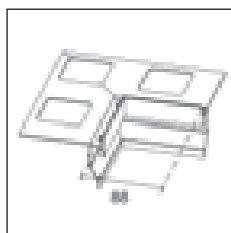

CPGV/55/ /I

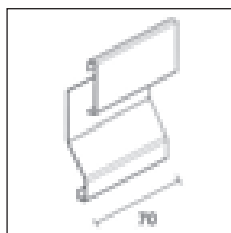

CPGV/55/ /G

**PROTEC**

length = 270 cm - pack 10 pcs

		H	
		10	12,5
<b>ART. finishing</b>		<b>CPGV/55/10</b>	<b>CPGV/55/12</b>
<b>COLOUR-COATED ALUMINIUM</b>			
ash grey RAL 7038		87580	87581
ash grey RAL 7038 embossed		87578	87579
metal grey RAL 9006		87590	87591
ancient grey		87582	87583
white stone		87547	87548
<b>euro/m</b>		<b>24,39</b>	<b>24,39</b>

white RAL 9003, dark brown RAL 8019 and aluminium grey RAL 9007 with a minimum of 270 meters, on request, without surcharge. For colours on request please contact our sales department.

**90° OUTSIDE CORNER**

pack 5 pcs

		H	
		10	12,5
<b>ART. finishing</b>		<b>CPGV/55/10/E</b>	<b>CPGV/55/12/E</b>
<b>COLOUR-COATED ALUMINIUM</b>			
ash grey RAL 7038		87584	87585
ash grey RAL 7038 embossed		87595	87596
metal grey RAL 9006		87592	87593
ancient grey		87586	87587
white stone		87536	87537
<b>euro/pc</b>		<b>31,69</b>	<b>31,69</b>

**90° INSIDE CORNER**

pack 5 pcs

		H	
		10	12,5
<b>ART. finishing</b>		<b>CPGV/55/10/I</b>	<b>CPGV/55/12/I</b>
<b>COLOUR-COATED ALUMINIUM</b>			
ancient grey		87566	87567
white stone		87538	87539
<b>euro/pc</b>		<b>34,52</b>	<b>34,52</b>

**JUNCTION**

width = 70 mm - pack 5 pcs

		H	
		10	12,5
<b>ART. finishing</b>		<b>CPGV/55/10/G</b>	<b>CPGV/55/12/G</b>
<b>COLOUR-COATED ALUMINIUM</b>			
ash grey RAL 7038		87610	87610
ash grey RAL 7038 embossed		87612	87612
metal grey RAL 9006		87594	87594
ancient grey		87611	87611
white stone		87528	87528
<b>euro/pc</b>		<b>7,68</b>	<b>7,68</b>

no partial packaging

For a single piece, see sales conditions on page 288



Protec CPQV is a perimetral profile for the protection and finishing of the outside edges of terraces and balconies. This profile is composed of a vertical part that covers the border of the floor and facilitates the outflow of rainwater from the tiled surface, and a sloping part equipped with holes for a further discharge of the water seeped under the tiles. This technical solution and the consequent drainage reduce the problems of freezing and thawing and the unsightly efflorescences on the tiles grouts. It can be used with tiles thicknesses up to 12,5 mm.

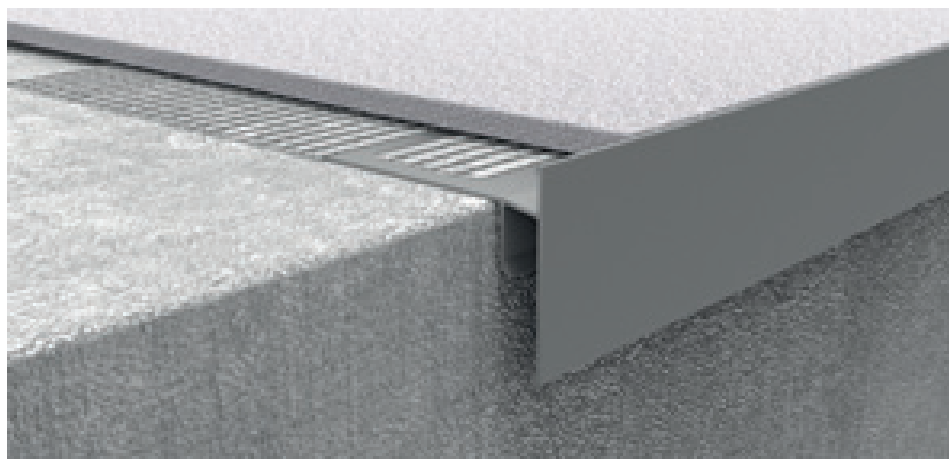

CPQV/50/10 ash grey RAL 7038 embossed colour-coated aluminium

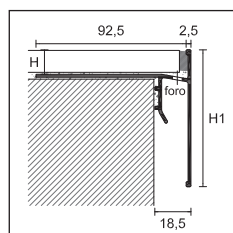

CPQV

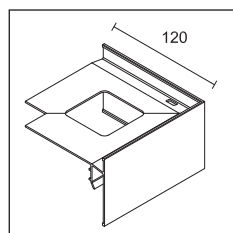

CPQV/I/E

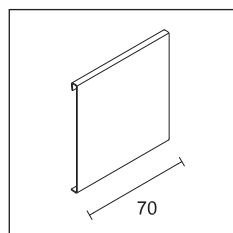

CPQV/I/G



CPQV ash grey RAL 7038

Complete the article code with H measure (for example CPQV/50/ for H=12,5 becomes CPQV/50/12)

For a single piece, see sales conditions on page 288

**NEW PROTEC**

length = 270 cm - pack 10 pcs

ART.	finishing	H			
		10	12,5	10	12,5
		<b>CPQV/50/ (H1=50)</b>		<b>CPQV/70/ (H1=70)</b>	
<b>COLOUR-COATED ALUMINIUM</b>					
	ash grey RAL 7038	86960	86961	86962	86963
	ash grey RAL 7038 embossed	86964	86965	86966	86967
	metal grey RAL 9006	86968	86969	86970	86971
	ancient grey	86972	86973	86974	86975
	white ST	86976	86977	86978	86979
	<b>euro/m</b>	<b>24,26</b>	<b>24,26</b>	<b>25,73</b>	<b>25,73</b>

white RAL 9003, dark brown RAL 8019 and aluminium grey RAL 9007 with a minimum of 270 meters, on request, without surcharge. For colours on request please contact our sales department.

**NEW 90° OUTSIDE CORNER**

pack 5 pcs

ART.	finishing	H			
		10	12,5	10	12,5
		<b>CPQV/50/ /E</b>		<b>CPQV/70/ /E</b>	
<b>COLOUR-COATED ALUMINIUM</b>					
	ash grey RAL 7038	86980	86981	86982	86983
	ash grey RAL 7038 embossed	86984	86985	86986	86987
	metal grey RAL 9006	86988	86989	86990	86991
	ancient grey	86992	86993	86994	86995
	white ST	86996	86997	86998	86999
	<b>euro/pc</b>	<b>31,71</b>	<b>31,71</b>	<b>31,71</b>	<b>31,71</b>

**NEW JUNCTION**

width = 70 mm - pack 5 pcs

ART.	finishing	H	
		CPQV/50/G	CPQV/70/G
<b>COLOUR-COATED ALUMINIUM</b>			
	ash grey RAL 7038	87000	87001
	ash grey RAL 7038 embossed	87002	87003
	metal grey RAL 9006	87004	87005
	ancient grey	87006	87007
	white ST	87008	87009
	<b>euro/pc</b>	<b>5,72</b>	<b>5,72</b>

no partial packaging

Protec CPEV and CPEI are a series of edge reversible profiles for the protection and finishing of the outside edges of terraces and balconies.

Available in stainless steel and colour-coated aluminium, they can be installed flush with the border or detached from it. They can be used with tiles or marble thicknesses from 11 to 32 mm.

The particular section is recommended to protect the stair nosing and sidewalk edge, hiding the connection between tread and riser.

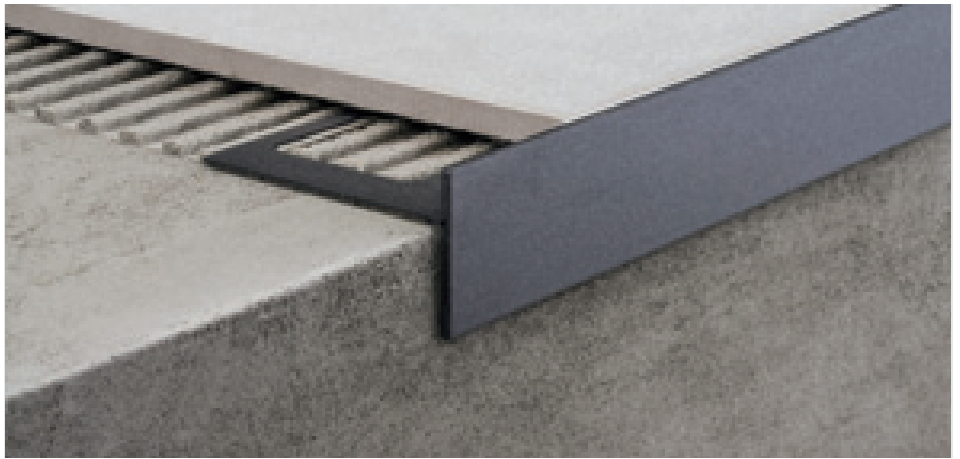

CPEV/45/12 colour-coated aluminium ancient grey

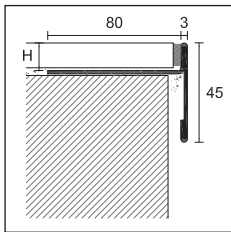

CPEV/45/

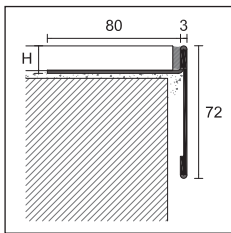

CPEV/72/

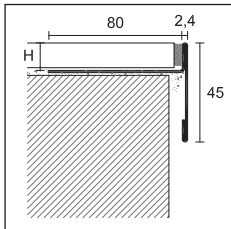

CPEI/

**PROTEC**



length = 270 cm - pack 10 pcs

	H				
	11	12,5	15	20	12,5

<b>ART.</b>	<b>CPEV/45/</b>				<b>CPEV/72/</b>
-------------	-----------------	--	--	--	-----------------

**finishing**

**COLOUR-COATED ALUMINIUM**

ash grey RAL 7038		87530	87550	87551	87552	87252
metal grey RAL 9006		87531	87540	87541	87542	-
ancient grey		87532	87553	87554	87555	-
<b>euro/m</b>		<b>20,44</b>	<b>20,44</b>	<b>20,44</b>	<b>20,44</b>	<b>23,14</b>

for CPEV/72 white RAL 9003, dark brown RAL 8019, metal grey RAL 9006, aluminium grey RAL 9007, ancient grey, ash grey RAL 7038 embossed and rust with minimum 270 meters, on request, without surcharge. For different colours, please contact our Sales Department. For CPEV/45 white RAL 9003, dark brown RAL 8019, aluminium grey RAL 9007, ash grey RAL 7038 embossed and rust with minimum 270 meters, on request, without surcharge. For colours on request please contact our sales department.

**PROTEC**

length = 270 cm - pack 10 pcs

	H		
	12,5	15	20

<b>ART.</b>	<b>CPEI/45/</b>		
-------------	-----------------	--	--

**STAINLESS STEEL**

polished stainless steel AISI 304 DIN 1.4301		-	87570	87571	87572
<b>euro/m</b>		-	<b>31,41</b>	<b>31,41</b>	<b>31,41</b>

Complete the article code with H measure (for example CPEV/45/ for H=12,5 becomes CPEV/45/12)

For a single piece, see sales conditions on page 288

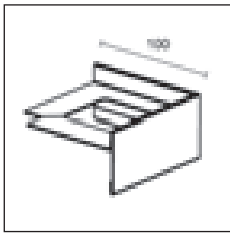

CPEV// /E  
CPEI// /E

**90° OUTSIDE CORNER**

pack 5 pcs	H					
	11	12,5	15	20	12,5	
ART.	CPEV/45/ /E				CPEV/72/ /E	
finishing						
<b>COLOUR-COATED ALUMINIUM</b>						
ash grey RAL 7038		87533	87556	87557	87558	87255
metal grey RAL 9006		87534	87543	87544	87545	-
ancient grey		87535	87559	87560	87561	-
<b>euro/pc</b>		<b>28,20</b>	<b>28,20</b>	<b>28,20</b>	<b>28,20</b>	<b>29,44</b>

**90° OUTSIDE CORNER**

pack 5 pcs	H				
	12,5	15	20		
ART.	CPEI/45/ /E				
<b>STAINLESS STEEL</b>					
polished stainless steel AISI 304 DIN 1.4301		-	87573	87574	87575
<b>euro/pc</b>		-	<b>38,55</b>	<b>38,55</b>	<b>38,55</b>

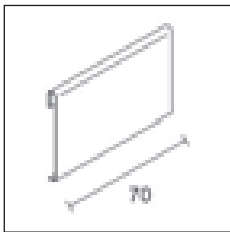

CPEV// /G  
CPEI// /G

**JUNCTION**

width = 70 mm - pack 5 pcs	H					
	11	12,5	15	20	12,5	
ART.	CPEV/45/ /G				CPEV/72/ /G	
finishing						
<b>COLOUR-COATED ALUMINIUM</b>						
ash grey RAL 7038		87562	87562	87562	87562	87258
metal grey RAL 9006		87546	87546	87546	87546	-
ancient grey		87563	87563	87563	87563	-
<b>euro/pc</b>		<b>5,72</b>	<b>5,72</b>	<b>5,72</b>	<b>5,72</b>	<b>5,72</b>

no partial packaging

**JUNCTION**

width = 70 mm - pack 5 pcs	H				
	12,5	15	20		
ART.	CPEI/45/ /G				
<b>STAINLESS STEEL</b>					
polished stainless steel AISI 304 DIN 1.4301		-	87576	87576	87576
<b>euro/pc</b>		-	<b>7,14</b>	<b>7,14</b>	<b>7,14</b>

no partial packaging



Complete the article code with H measure  
(for example CPEV/45/ for H=12,5 becomes  
CPEV/45/12)

For a single piece, see sales conditions on page 288 CPEV/45/12/E + CPEV/45/12/G ancient grey colour-coated aluminium

cerfix® protec

Protec CPHA - CPHV is an edge profile in anodised and colour-coated aluminium for terraces, balconies and sidewalks. The shape allows the outflow of water, avoiding the direct contact with the screed. Installed along the perimeter, it allows to outline the ceramic tiles and to protect the border in many fields of use. It can be used with tiles thicknesses up to 21 mm.



CPHA/10 silver anodised aluminium

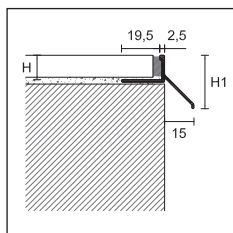

CPHA/  
CPHV/

PROTEC

length = 270 cm - pack 10 pcs

		H (H1)			
ART.	finishing	8 (23)	10 (25)	12,5 (27)	21 (36)
<b>ALUMINIUM</b>					
<b>CPHA/</b>	silver anodised	87599	87600	87601	87602
	<i>euro/m</i>	<b>5,39</b>	<b>5,49</b>	<b>5,67</b>	<b>6,99</b>
<b>COLOUR-COATED ALUMINIUM</b>					
	ash grey RAL 7038	-	87606	87607	87608
<b>CPHV/</b>	ash grey RAL 7038 embossed	-	87637	87638	-
	ancient grey	-	87639	87640	-
	<i>euro/m</i>	-	<b>6,99</b>	<b>7,19</b>	<b>8,75</b>

white RAL 9003, dark brown RAL 8019, metal grey RAL 9006, aluminium grey RAL 9007 and ancient grey with a minimum of 270 meters, on request, without surcharge. For colours on request please contact our sales department.

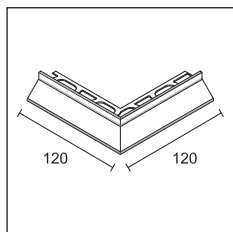

CPHA/ E  
CPHV/ E

90° OUTSIDE CORNER

dimension = 12x12 cm - pack 5 pcs

		H (H1)			
ART.	finishing	8 (23)	10 (25)	12,5 (27)	21 (36)
<b>ALUMINIUM</b>					
<b>CPHA/ E</b>	silver anodised	87564	87565	87597	87598
	<i>euro/pc</i>	<b>13,72</b>	<b>13,72</b>	<b>13,72</b>	<b>13,72</b>
<b>COLOUR-COATED ALUMINIUM</b>					
	ash grey RAL 7038	-	87603	87604	87609
<b>CPHV/ E</b>	ash grey RAL 7038 embossed	-	87641	87642	-
	ancient grey	-	87643	87644	-
	<i>euro/pc</i>	-	<b>13,72</b>	<b>13,72</b>	<b>13,72</b>



CPHA/ E silver anodised aluminium

Complete the article code with H measure (for example CPHA/ for H=10 becomes CPHA/10)

For a single piece, see sales conditions on page 288

Protec CPLV is a line of perimetral profiles in colour-coated aluminium, for the protection and finishing of the borders of outdoor raised floors, terraces or balconies. They are composed of a drilled base CPLB to be screwed to the supports, or, as an alternative, a cut base CPLB/2 for glued tiles, and a visible profile to be fixed with adhesive, available in 3 different heights according to the floor thickness. There are also special accessories for the creation of external corners and junctions.



CPLB + CPLV/60 ash grey RAL 7038 colour-coated aluminium

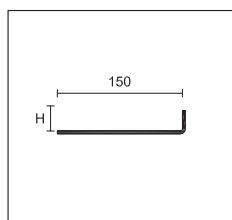
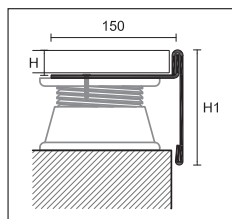

CPLB  
base for raised  
floors

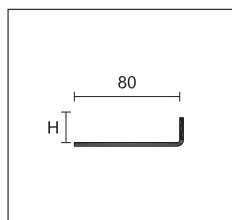

CPLB/2  
punched base  
for tiled floors

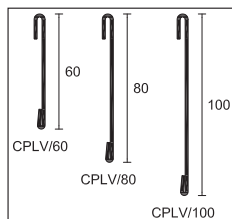

CPLV/

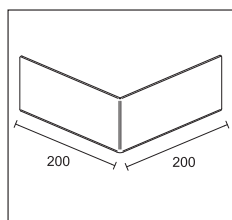

CPLV/ E

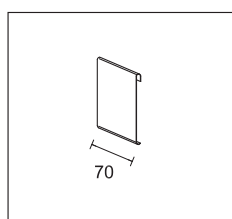

CPLV/ G

**PROTEC**

length = 270 cm - pack 10 pcs

**H**

**BASE**

**ART. finishing**

**20**

**ALUMINIUM**

<b>CPLB</b>	natural aluminium		86900
	euro/m		<b>21,40</b>
<b>NEW CPLB/2</b>	natural aluminium		86901
	euro/m		<b>11,64</b>

CPLB with draining holes available on request, extra euro/m 2,71  
CPLB and CPLB/2 in 15 and 25 mm height available on request  
possibility to choose noise-proof rubber PPL/GM, see page 253

**PROTEC**

length = 270 cm - pack 10 pcs

**H1**

**FRONT**

**ART. finishing**

**60**

**80**

**100**

**NEW COLOUR-COATED ALUMINIUM**

	ash grey RAL 7038		86902	86904	86906
	ancient grey		86903	86905	86907
<b>CPLV/</b>	stone		86908	86909	86910
	greige		86911	86912	86913
	sand		86914	86915	86916
	beige		86917	86918	86919
	euro/m		<b>15,86</b>	<b>18,38</b>	<b>20,75</b>

white RAL 9003, dark brown RAL 8019, metal grey RAL 9006, aluminium grey RAL 9007, ash grey RAL 7038 embossed and rust with a minimum of 270 meters, on request, without surcharge. For other colours please contact our sales department.

**90° OUTSIDE CORNER**

pack 5 pcs

**H1**

**ART. finishing**

**60**

**80**

**100**

**NEW COLOUR-COATED ALUMINIUM**

	ash grey RAL 7038		86920	86922	86924
	ancient grey		86921	86923	86925
<b>CPLV/ E</b>	stone		86926	86927	86928
	greige		86929	86931	86933
	sand		86935	86936	86937
	beige		86938	86939	86940
	euro/pc		<b>26,95</b>	<b>26,95</b>	<b>26,95</b>

**NEW JUNCTION**

width = 70 mm - pack 5 pcs

**H1**

**ART. finishing**

**60**

**80**

**100**

**COLOUR-COATED ALUMINIUM**

	ash grey RAL 7038		86930	86932	86934
	ancient grey		86941	86942	86943
<b>CPLV/ G</b>	stone		86944	86945	86946
	greige		86947	86948	86949
	sand		86950	86951	86952
	beige		86953	86954	86955
	euro/pc		<b>5,46</b>	<b>5,46</b>	<b>5,46</b>

no partial packaging

For a single piece, see sales conditions on page 288





## stair nosing profiles

Protection, finishing and safety. Protect and Prostep are two ranges of stair nosing profiles for stairs for public and private use.

# stair nosing profiles

## cerfix® prostep

Prostep SGA, SGI, SGN and SGK are profiles for the realization and protection of ceramic, marble and stone steps. Thanks to the rounded section, they give elegance to the steps. The models in chromium-plated brass and anodized aluminium are not recommended in case of intense foot traffic, while those in stainless steel are particularly suitable for heavy foot traffic.



SGI/11 polished stainless steel AISI 304 DIN 1.4301

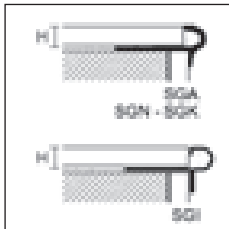

### PROSTEP

length = 270 cm - pack 10 pcs

		H			
ART.	finishing	7	9	11	13
<b>ALUMINIUM</b>					
<b>SGA/</b>	silver anodised	94965	94966	94967	94968
	<i>euro/m</i>	<b>7,98</b>	<b>8,45</b>	<b>8,91</b>	<b>9,37</b>
<b>STAINLESS STEEL</b>					
<b>SGI/</b>	polished stainless steel AISI 304 DIN 1.4301	-	94922	94924	-
	<i>euro/m</i>	-	<b>12,93</b>	<b>14,01</b>	-
<b>BRASS</b>					
<b>SGN/</b>	natural brass	94970	94971	94972	-
	<i>euro/m</i>	<b>23,58</b>	<b>24,38</b>	<b>25,98</b>	-
<b>CHROMIUM-PLATED BRASS</b>					
<b>SGK/</b>	chromium-plated brass	94980	94981	94982	-
	<i>euro/m</i>	<b>30,64</b>	<b>31,40</b>	<b>32,87</b>	-

individually packed - art. SGK/9 and SGK/11 pack 5 pcs

PPDESIGN

Prostep SMA and SM are aluminium and brass profiles for realization and protection of ceramic, marble and stone steps. Thanks to the grooved top part, they are consistent with DIN 51131 law concerning non-slip stair nosing.



SMA/4,5 natural aluminium

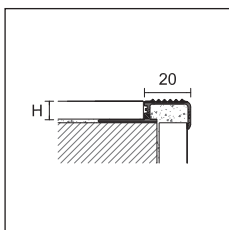

SMA/  
SM/

### PROSTEP

length= 270 cm - pack 10 pcs

		H				
ART.	finishing	4,5	8	10	11	12,5
<b>ALUMINIUM</b>						
	natural aluminium	93967	93969	93970	93979	93971
<b>SMA/</b>	<i>euro/m</i>	<b>6,26</b>	<b>7,00</b>	<b>7,34</b>	<b>7,57</b>	<b>7,74</b>
	silver anodised	93975	93976	93977	93980	93978
	<i>euro/m</i>	<b>7,52</b>	<b>8,24</b>	<b>8,56</b>	<b>8,79</b>	<b>9,00</b>
<b>BRASS</b>						
<b>SM/</b>	natural brass	-	-	93972	-	93973
	<i>euro/m</i>	-	-	<b>28,99</b>	-	<b>30,65</b>

individually packed

Complete the article code with H measure (for example for SGA/ for H=11 becomes SGA/11)

For a single piece, see sales conditions on page 288



Protrim IPI/ are minimal profiles in aluminium or stainless steel suitable for the edging of external corners that need the 45 degrees cut. These profiles allow a perfect laying both on coverings and on stairs or platforms in ceramic or wood.



IPA/11 silver anodised aluminium

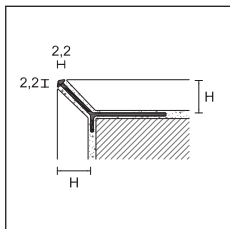

IPA/  
IPB/

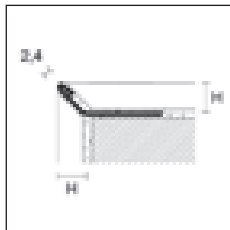

IPI/

Prostep SNG and SN are aluminium and brass profiles for realization and protection of ceramic, marble and stone steps.



SNG/10 silver anodised aluminium

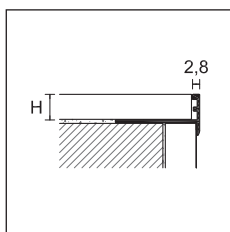

SNG/  
SN/

**PROTRIM IP**

length = 270 cm - pack 20 pcs

		H			
ART.	finishing	4,5	8	11	15
<b>ALUMINIUM</b>					
IPA/	silver anodised	95006	95178	95181	95185
	euro/m	4,17	4,28	4,28	4,50
IPB/	bright polished silver	95008	-	-	-
	euro/m	7,02	-	-	-

individually packed

**PROTRIM IP**

length = 270 cm - pack 20 pcs

		H			
ART.	finishing	7	8	11	12,5
<b>STAINLESS STEEL</b>					
IPI/	stainless steel AISI 304 - DIN 1.4301	95169	95170	95173	95174
	euro/m	8,45	8,73	9,24	9,63

individually packed

**PROSTEP**

length = 270 cm - pack 20 pcs

		H			
ART.	finishing	8	10	12,5	15
<b>ALUMINIUM</b>					
	natural aluminium	90040	90042	90044	90046
SNG/	euro/m	3,12	3,20	3,38	3,68
	silver anodised	90041	90043	90045	90047
	euro/m	4,24	4,34	4,46	4,94
SN/	natural brass	93991	93992	93993	-
	euro/m	14,21	14,66	15,18	-

individually packed - SN/ pack 10 pcs

Complete the article code with H measure (for example IPA/ for H=11 becomes IPA/11)

For a single piece, see sales conditions on page 288

# stair nosing profiles

## cerfix® prostep

Prostep SAR and SIR are stair nosing profiles in aluminium and stainless steel, suitable for the protections of steps or pavements. Thanks to the reversible shapes, these two models can be used for tiles of four different thicknesses.



SAR/10/12 silver anodised aluminium



SIR/10/12 stainless steel AISI 304 DIN 1.4301

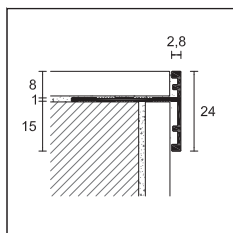

SAR/8

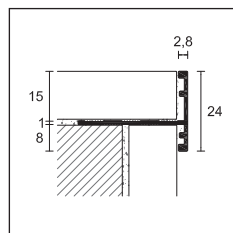

SAR/15

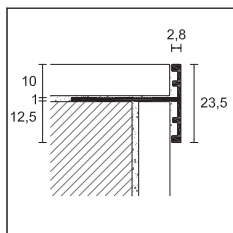

SAR/10

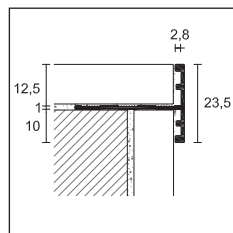

SAR/12

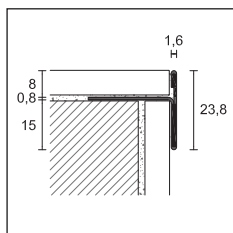

SIR/8  
SIRS/8

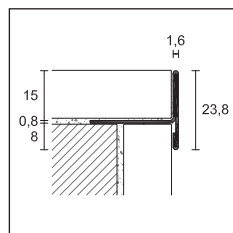

SIR/15  
SIRS/15

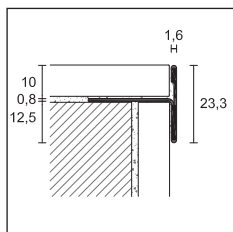

SIR/10  
SIRS/10

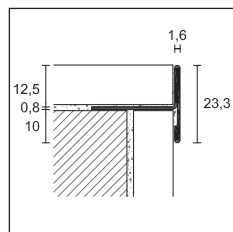

SIR/12  
SIRS/12

### PROSTEP

length = 270 cm - pack 10 pcs

ART. finishing

#### ALUMINIUM

<b>SAR/8/15</b>	silver anodised		93956
	<i>euro/m</i>		<b>6,99</b>
<b>SAR/10/12</b>	silver anodised		93958
	<i>euro/m</i>		<b>6,99</b>

individually packed

### PROSTEP

length = 270 cm - pack 10 pcs

ART. finishing

#### STAINLESS STEEL

<b>SIR/8/15</b>	polished stainless steel AISI 304 DIN 1.4301		93952
	<i>euro/m</i>		<b>15,04</b>
<b>SIR/10/12</b>	polished stainless steel AISI 304 DIN 1.4301		93954
	<i>euro/m</i>		<b>15,04</b>
<b>SIRS/8/15</b>	satin stainless steel AISI 304 DIN 1.4301		93953
	<i>euro/m</i>		<b>16,89</b>
<b>SIRS/10/12</b>	satin stainless steel AISI 304 DIN 1.4301		93955
	<i>euro/m</i>		<b>16,89</b>

individually packed

Prostep SIS is a stainless steel profile for the realization and protection of ceramic, marble and stone steps. Thanks to the satin and knurled tread, it is compliant with non-slip stair regulation DIN 51131. Prostep SIS is particularly suitable for the protection of steps subject to heavy pedestrian traffic.



SIS/10 satin stainless steel AISI 304 - DIN 1.4301

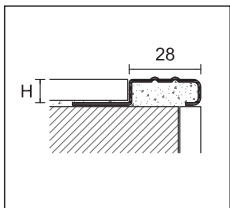

SIS/

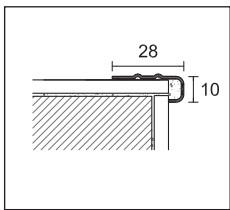

SIS/10/SF

**PROSTEP**

		length = 270 cm - pack 10 pcs		
		H		
ART.	finishing	10	11	12,5
<b>STAINLESS STEEL</b>				
SIS/	satin stainless steel AISI 304 DIN 1.4301	93987	93989	93988
	euro/m	19,05	19,22	19,35
SIS/10/SF	satin stainless steel AISI 304 DIN 1.4301	93997	-	-
	euro/m	12,78	-	-

individually packed

Prostep SIX is a stainless steel profile for realization and protection of ceramic, marble and stone steps. They are in accordance with DIN 51131 regulation of non-slip stair nosing thanks to the application of non-slip strips: Safety-Step. It is particularly suitable to protect the stairs in case of high pedestrian traffic.

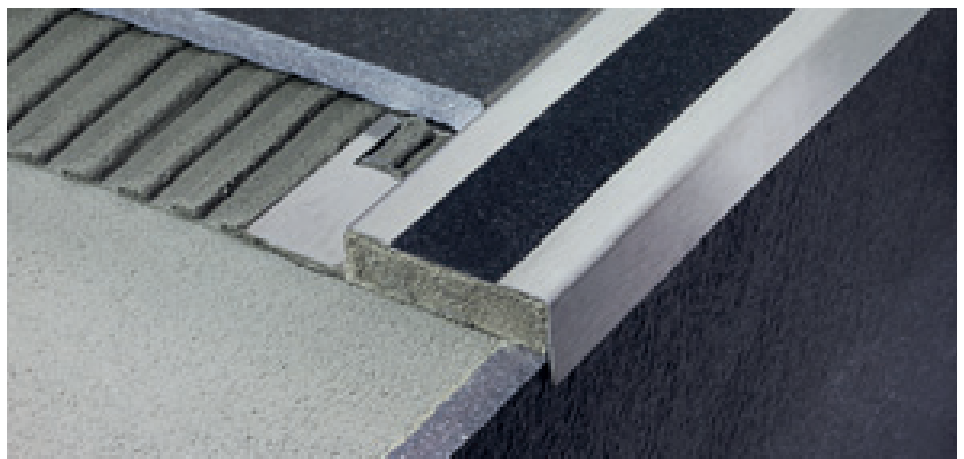

SIX/10 satin stainless steel AISI 304 - DIN 1.4301 + black slip-resistant 25 mm

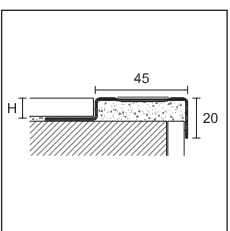

SIX/

**PROSTEP**

		length = 270 cm - pack 10 pcs		
		H		
ART.	finishing	8	10	12,5
<b>STAINLESS STEEL</b>				
SIX/	satin stainless steel AISI 304 DIN 1.4301 + black slip-resistant 25 mm	93981	93982	93983
	euro/m	25,27	27,14	29,00

individually packed

Complete the article code with H measure (for example SIS/ for H=10 becomes SIS/10)

For a single piece, see sales conditions on page 288

# stair nosing profiles

## cerfix® prostep

Prostep Wood is a line of profiles in solid wood and aluminium base for the realization and protection of ceramic, wood or cotto tile steps. Available in different heights, we recommend to paint it immediately after installation for the best finishing and durability results.



SWA/10 oak

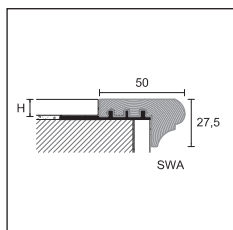

SWA/

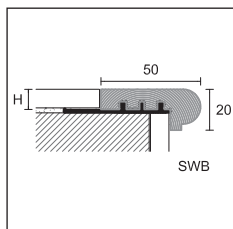

SWB/

### PROSTEP WOOD

length = 270 cm - pack 5 pcs

		H		
ART.	finishing	10	12,5	15
SWA/	oak	90480	90484	90488
	euro/m	47,02	48,43	50,01
SWB/	oak	90512	90516	-
	euro/m	37,57	39,00	-

art. SWA and SWB available in length 90-135 cm with a minimum order of 12 pcs and a surcharge euro/pc 3,00.

Prostep SP is a line of profiles in PVC with aluminium base for realization and protection of ceramic, stone or brick floors. The grooved PVC insert is in accordance with DIN 51131 regulation of non-slip stair nosing.



SP/10 + Black PVC

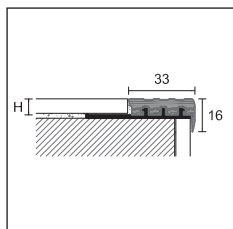

SP/

### PROSTEP

length = 270 cm - pack 10 pcs

		H		
ART.	finishing	8	10	12,5
SP/	aluminium + black PVC	95200	95210	95220
	euro/m	14,66	15,70	16,97

Complete the article code with H measure  
(for example SWA/ for H=10 becomes SWA/10)

For a single piece, see sales conditions on page 288

Prostep SA and SB is a line of profiles in PVC with aluminium base for realization and protection of ceramic, stone or brick floors. The grooved PVC insert is in accordance with DIN 51131 regulation of non-slip stair nosing.

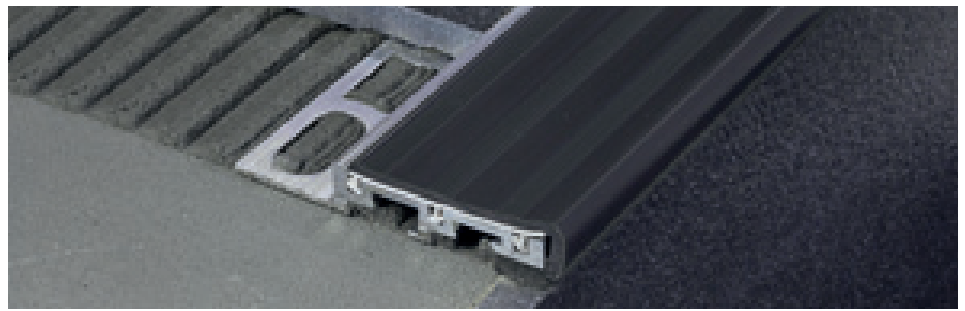

SB/10 aluminium + dark grey PVC

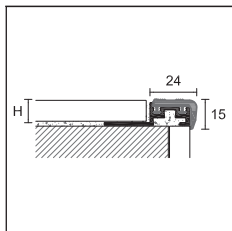

SA/

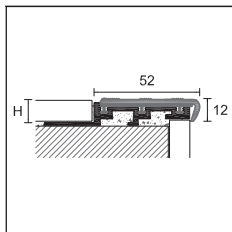

SB/

Prostep 111 and 75 are anodised aluminium profiles for realization and protection of stairs with floors with small thickness. They are suitable also for LVT floorings.



111/4/F silver anodised aluminium



75/F silver anodised aluminium

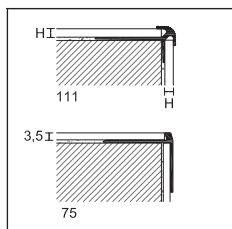

**PROSTEP**

length = 270 cm - pack 10 pcs

ART.	finishing	8	10	12,5	15
SA/	aluminium + dark grey PVC	94041	94101	94161	-
	euro/m	12,39	13,31	13,73	-

**SPARE PVC - pack 10 pcs**

SA/G	dark grey PVC			94913	
	euro/m			3,99	

length = 270 cm - pack 10 pcs

ART.	finishing	8	10	12,5	15
SB/	aluminium + dark grey PVC	94441	94501	94561	94621
	euro/m	19,54	20,31	20,93	21,97

**SPARE PVC - pack 10 pcs**

SB/G	dark grey PVC			94963	
	euro/m			6,72	

no partial packaging with SA/G and SB/G

**PROTECT**

length = 270 cm - pack 20 pcs

ART.	finishing	2,5	4,5	5	6
111/ /F	silver anodised	75782	75784	75785	75786
	euro/m	6,77	7,13	7,38	7,67

**PROTECT**

length = 340 cm - pack 20 pcs

ART.	finishing	3,5
75/F	silver anodised	75388
	euro/m	6,45

Complete the article code with H measure (for example SA/ for H=8 becomes SA/8)

For a single piece, see sales conditions on page 288

# stair nosing profiles

## protect

Protect 73, 74 and 58 are profiles for protection of step edge in wood, ceramic or marble already laid.

Protec 87, 370 and 373 are in accordance with DIN 51131 regulation of non-slip stair nosing. They are available in version with the holes and self-adhesive.



74/SF silver anodised aluminium

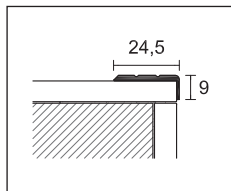

73/

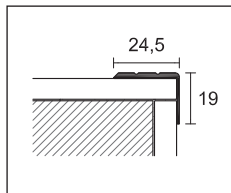

74/

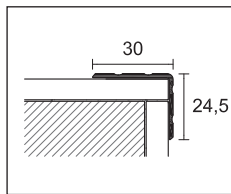

58/

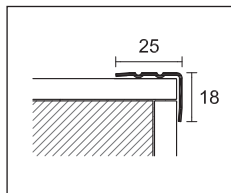

74/IF

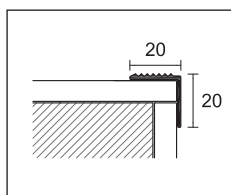

87/  
370/

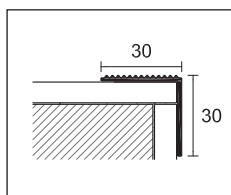

373/

Complete the article code with F=drilled, A/AD=adhesive, SF=undrilled, CV=screws (eg. 73/F)



 packaging in blister no partial packaging

For a single piece, see sales conditions on page 288

### PROTECT



pack	30 pcs			10 pcs / blister 			
length cm	270			90	100		-
ART.	73/			473/			-
finishing	F	SF	A	CV	AD	CV	-

### ALUMINIUM

silver anodised		75208	75209	75238	21422	21434	00337	-
gold anodised		75218	-	75248	21423	21435	00338	-
bronze anodised		-	-	75258	-	-	-	-
euro/m		3,84	3,69	5,06	-	-	-	-
euro/pc		-	-	-	4,58	5,45	4,97	-

pack	20 pcs.	30 pcs			10 pcs / blister 			20 pcs	
ART.	58/	74/			474/			74/I	
finishing	A	-	F	SF	A	CV	AD	CV	F

### ALUMINIUM

silver anodised		75900	-	75268	75269	75298	21512	21524	00390	-
gold anodised		-	-	75278	-	75308	21513	21525	00392	-
bronze anodised		-	-	-	-	75318	-	-	-	-
euro/m		6,25	-	4,41	4,26	5,63	-	-	-	-
euro/pc		-	-	-	-	-	5,07	5,92	5,50	-

titanium anodised		-	-	-	-	75299	-	-	-	-
euro/m		-	-	-	-	7,15	-	-	-	-

length cm										270
-----------	--	--	--	--	--	--	--	--	--	-----

### STAINLESS STEEL

satin stainless steel AISI 304 DIN 1.4301		-	-	-	-	-	-	-	-	75275
euro/m		-	-	-	-	-	-	-	-	17,16

art. 73/, 58/ and 74/ individually packed

### PROTECT

pack	30 pcs			10 pcs / blister 		
length cm	340			113		
ART.	87/			487/		
finishing	F	SF	A	CV	AD	

### ALUMINIUM

silver anodised		75108	75109	75138	22615	22641
euro/m		5,12	4,97	6,76	-	-
euro/pc		-	-	-	7,12	8,70

pack	10 pcs			5 pcs		
length cm	270			270		
ART.	370/			373/		

finishing	F	SF	A	F	A
-----------	---	----	---	---	---

### BRASS

polished		-	75169	75178	75188	75198
euro/m		-	22,10	25,11	29,73	32,45

art. 87/ and 370/ individually packed

Prostep Flex is a line of bendable profiles for the protection of steps or platforms. These profiles can be curved through our Proflex Machine.

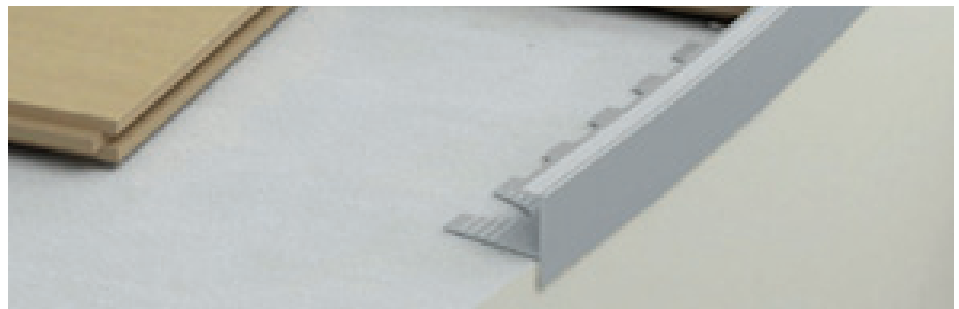

GF/710 silver anodised aluminium

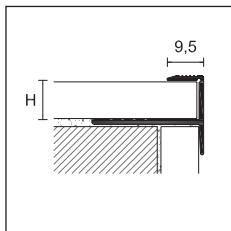

GF/

**PRO FLEX LINE**

**PROSTEP FLEX**

length = 270 cm - pack 10 pcs

		H	
ART.	finishing	10	15
<b>ALUMINIUM</b>		<b>710</b>	<b>715</b>
<b>GF/</b>	silver anodised	67569	67350
	gold anodised	-	-
<b>euro/m</b>		<b>7,13</b>	<b>7,54</b>

individually packed

Protect 70, 71 and 130 are profiles for protection of step edge in wood, ceramic or marble already laid. They are in accordance with DIN51131 regulation concerning non-slip stair nosing. They are available in the version with holes and self-adhesive and they are particularly suitable for public environments in adaptation to standards.

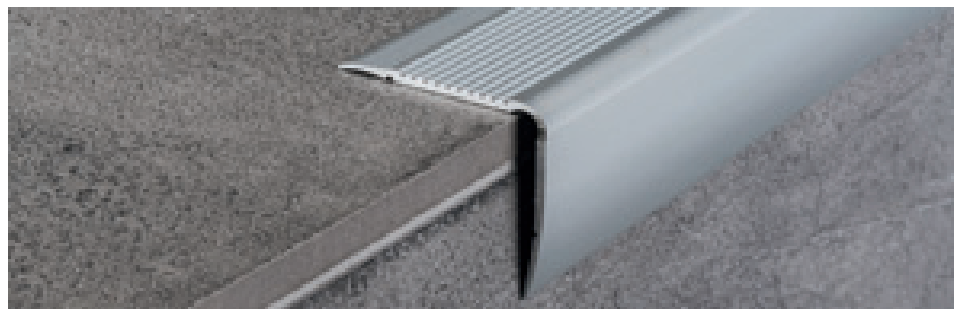

71/SF silver anodised aluminium

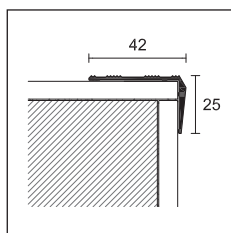

70/

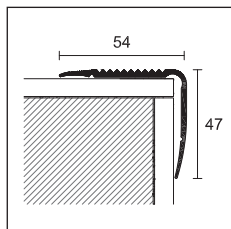

71/

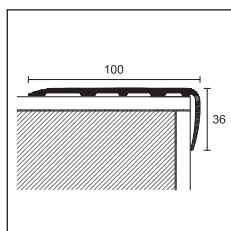

130/

**PROTECT**

pack	20	10 pcs / blister	
length cm	340	113	166
<b>ART.</b>	<b>70/</b>	<b>470/</b>	
<b>finishing</b>	<b>F</b>	<b>SF</b>	<b>A</b>
<b>ALUMINIUM</b>			
silver anodised	75328	75329	75358
gold anodised	75338	-	75368
<b>euro/m</b>	<b>8,30</b>	<b>8,12</b>	<b>10,08</b>
<b>euro/pc</b>	-	-	-
		<b>11,01</b>	<b>15,87</b>

art. 70/ individually packed

**PROTECT**

pack	10 pcs	8 pcs	
length cm	340	270	
<b>ART.</b>	<b>71/</b>	<b>130/</b>	
<b>finishing</b>	<b>F</b>	<b>SF</b>	<b>F</b>
<b>ALUMINIUM</b>			
silver anodised	64067	64066	75804
<b>euro/m</b>	<b>14,51</b>	<b>13,89</b>	<b>24,76</b>
			<b>75805</b>
			<b>23,84</b>

Complete the article code with F=drilled, A/AD=adhesive, SF=undrilled, CV=with screws (eg. 87/ drilled becomes 87/F) - packaging in blister no partial packaging - For a single piece, see sales conditions on page 288

# stair nosing profiles

## protect

Protect 76, 124, 110, 80 and 126 are anodised aluminium profiles with non-slip Safety-Step inserts or rubber for the protection of already-laid ceramic, wood or carpet steps. Compliant with DIN 51131 regulation regarding non-slip steps, they are available in drilled version and are particularly suitable for public spaces for the adaptation to standards.

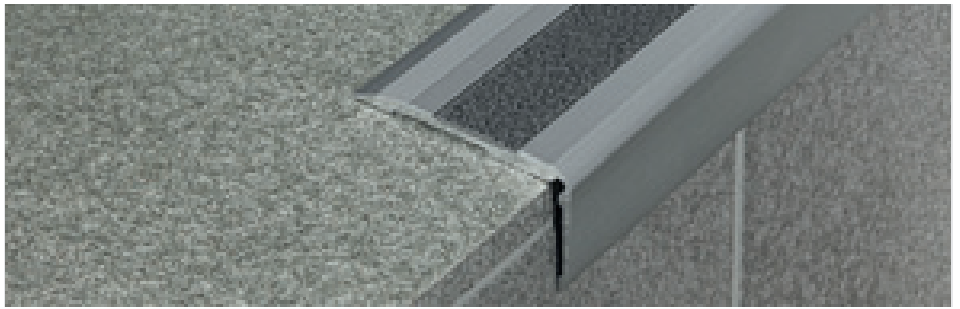

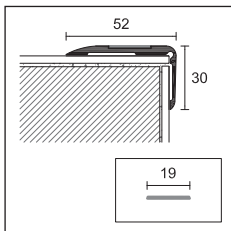

76/F silver anodised aluminium + black slip-resistant insert



76/

### PROTECT

pack	10 pcs	5 pcs / blister 	
length cm	340	113	
ART.	76/	476/	
finishing	F	CV	AD
<b>ALUMINIUM</b>			
silver anodised	 75448	21680	21696
euro/m	12,10	-	-
euro/pc	-	17,75	19,74

### SLIP-RESISTANT ROLL

length = 1820 cm - width mm	19		
4 rolls pack -			
black		23002	
euro/m		1,84	

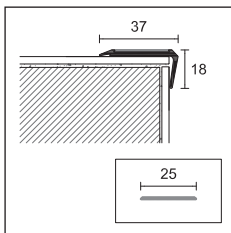

124/

### PROTECT

length = 270 cm - pack 24 pcs			
ART.	124/		
finishing	F		
<b>ALUMINIUM</b>			
silver anodised		75794	
euro/m		10,16	

### SLIP-RESISTANT ROLL

length = 1820 cm - width mm	25		
4 rolls pack -			
black		23004	
euro/m		2,43	

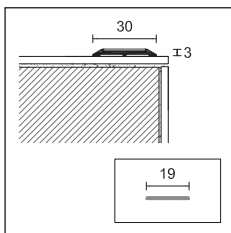

110/

### PROTECT

length = 270 cm - pack 24 pcs			
ART.	110/		
finishing	F		
<b>ALUMINIUM</b>			
silver anodised		75780	
euro/m		9,27	

### SLIP-RESISTANT ROLL

length = 1820 cm - width mm	19		
4 rolls pack -			
black		23002	
euro/m		1,84	

The price per meter of 76/, 124/ and 110/ does not include the non-slip insert that must be ordered separately.

Complete the article code with F=drilled, AD=adhesive, CV=screws (eg. 110/ drilled becomes 110/F)

 packaging in blister no partial packaging

For a single piece, see sales conditions on page 288



124/F silver anodised aluminium + black slip-resistant insert

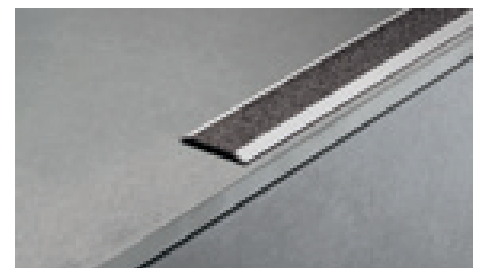

110/F silver anodised aluminium + black slip-resistant insert



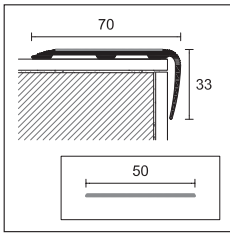

80/

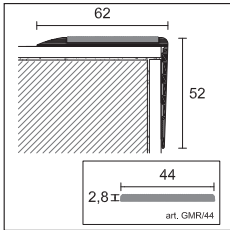

126/

**PROTECT**

length = 340 cm - pack 10 pcs

**ART.** 80/

**finishing** F

**ALUMINIUM**

silver anodised  64077

**euro/m** 15,57

**SLIP-RESISTANT ROLL**

length = 1820 cm - width mm 50

2 rolls pack - black  23006

**euro/m** 4,82

**PROTECT**

length = 270 cm - pack 6 pcs

**ART.** 126/

**finishing** F

**ALUMINIUM**

silver anodised  75798

**euro/m** 15,10

**GROOVED RUBBER**

length = 1700 cm - 1 rolls pack

**ART.** GMR/44

black  75706

**euro/m** 6,30



80/F silver anodised aluminium

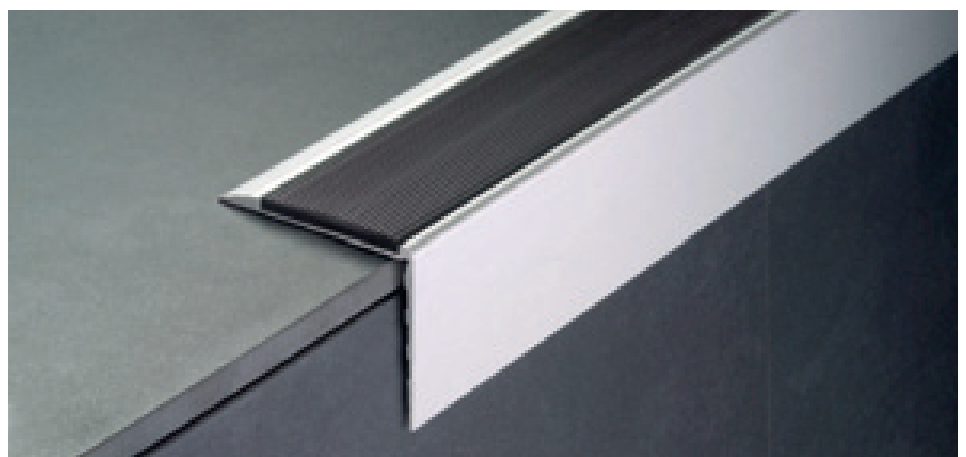

126/F silver anodised aluminium

The price per meter of 80/ does not include the non-slip insert that must be ordered separately.

The price per meter of 126/ does not include the grooved rubber that must be ordered separately.

Complete the article code with F=drilled (for example 80/ drilled becomes 80/F)

For a single piece, see sales conditions on page 288

# stair nosing profiles

## protect

Protect 72, 79, 125 and 78 are anodised aluminium profiles with rubber insert replaceable for the protection fo step edge in ceramic, wood, marble and carpet already laid. They are in accordance with DIN 51131 regulation of non-slip stair nosing. They are available in the version with holes and they are particularly suitable for public environments in adaptation to standards.

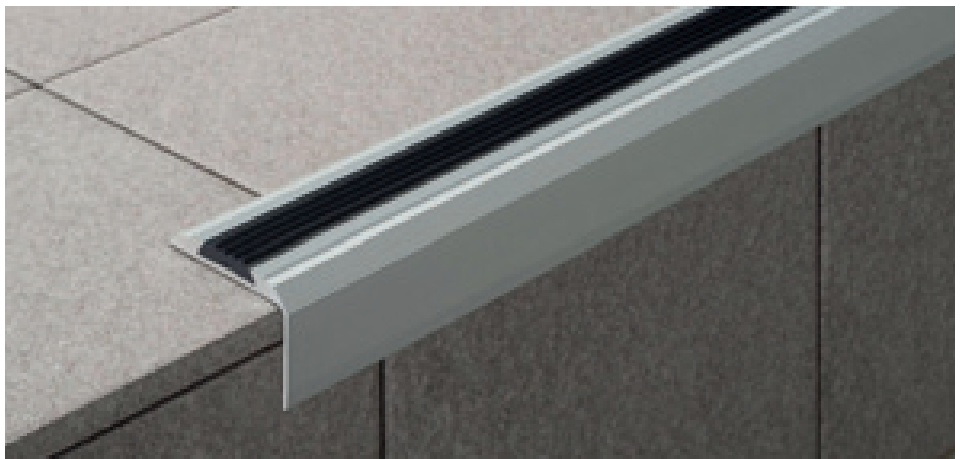

72/F silver anodised aluminium + GM/72 black

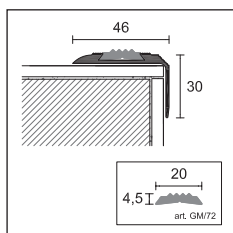

72/

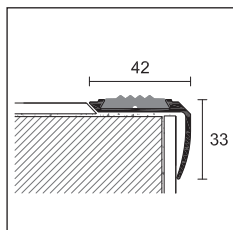

79/F + GM/R

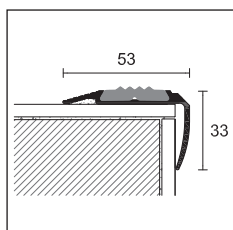

125/F + GM/R

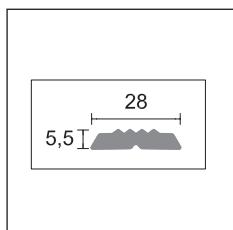

GM/R



The price per meter of 72/, 79/ and 125/ does not include the grooved rubber that must be ordered separately.

Complete the article code with F=drilled (for example 72/ drilled becomes 72/F)

For a single piece, see sales conditions on page 288

### PROTECT

length = 340 cm - pack 10 pcs



<b>ART.</b>		<b>72/</b>
<b>finishing</b>		<b>F</b>
<b>ALUMINIUM</b>		
silver anodised		75508
gold anodised		75518
<b>euro/m</b>		<b>10,30</b>

### GROOVED RUBBER

length = 3400 cm - 2 rolls pack

<b>ART.</b>		<b>GM/72</b>
black		75565
<b>euro/m</b>		<b>1,91</b>

### PROTECT

pack	10	10
length cm	340	270
<b>ART.</b>	<b>79/</b>	<b>125/</b>
<b>finishing</b>	<b>F</b>	<b>F</b>
<b>ALUMINIUM</b>		
silver anodised		75728
bronze anodised		-
<b>euro/m</b>	<b>8,28</b>	<b>12,55</b>

### GROOVED RUBBER

length = 3400 cm - 2 rolls pack

<b>ART.</b>		<b>GM/R</b>
black		75705
<b>euro/m</b>		<b>2,40</b>

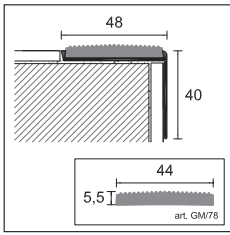

78/

**PROTECT**

length = 340 cm - pack 20 pcs

**ART.** **78/**

**finishing** **F**

**ALUMINIUM**

silver anodised  75578

**euro/m** **9,83**

**GROOVED RUBBER**

length = 1700 cm - 2 rolls pack

**ART.** **GM/78**

black  75635

**euro/m** **4,58**



125/F silver anodised aluminium + GM/R black

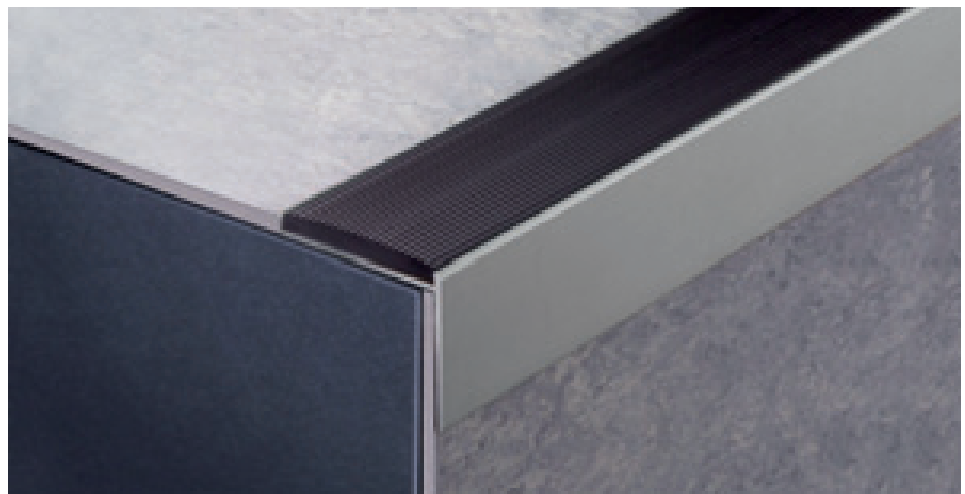

78/F silver anodised aluminium

The price per meter of 78/ does not include the grooved rubber that must be ordered separately.

Complete the article code with F=drilled (for example 78/ drilled becomes 78/F)

For a single piece, see sales conditions on page 288

# stair nosing profiles

## protect

Protect 150, 151, 152, 154, 155 and 156 are PVC profiles for the protection of the step edge in ceramic, marble, wood, PVC, linoleum, carpet or LVT to be laid or already laid.

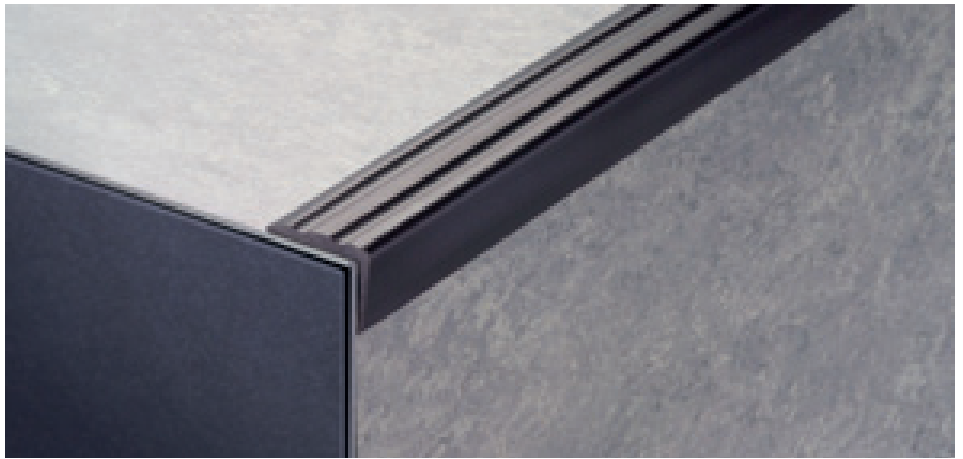

150 Black PVC

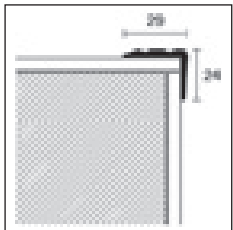

150

### PROTECT

length = 300 cm - pack 15 pcs

#### ART. finishing

#### PVC

	black		19100
<b>150</b>	grey		19101
	brown		19102
	<b>euro/m</b>		<b>2,58</b>

no partial packaging

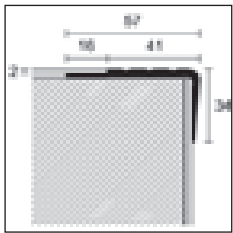

151

### PROTECT

length = 300 cm - pack 15 pcs

#### ART. finishing

#### PVC

	black		19110
<b>151</b>	grey		19111
	brown		19112
	<b>euro/m</b>		<b>3,90</b>

no partial packaging

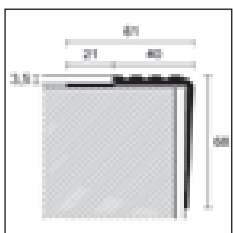

152

### PROTECT

length = 300 cm - pack 15 pcs

#### ART. finishing

#### PVC

	black		19120
<b>152</b>	grey		19121
	brown		-
	<b>euro/m</b>		<b>5,24</b>

no partial packaging



151 Black PVC

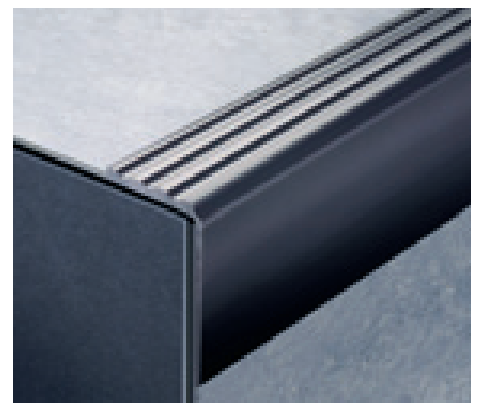

152 Grey PVC

All articles Protect in PVC should be stored horizontally

For a single piece, see sales conditions on page 288

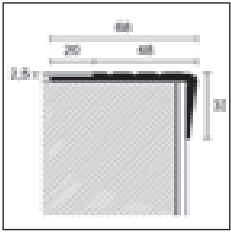

154

**PROTECT**

length = 300 cm - pack 15 pcs

**ART. finishing**

**PVC**

	black		19140
<b>154</b>	grey		19141
	brown		-
	<b>euro/m</b>		<b>4,78</b>

no partial packaging

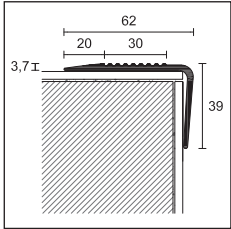



155

**PROTECT**

length = 300 cm - pack 15 pcs

**ART. finishing**

**PVC**

	black		19150
<b>155</b>	grey		19151
	brown		19152
	<b>euro/m</b>		<b>4,49</b>

no partial packaging

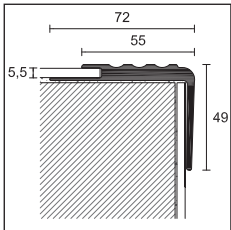

156

**PROTECT**

length = 300 cm - pack 10 pcs

**ART. finishing**

**PVC**

	black		19160
<b>156</b>	grey		19161
	brown		19162
	<b>euro/m</b>		<b>7,96</b>

no partial packaging

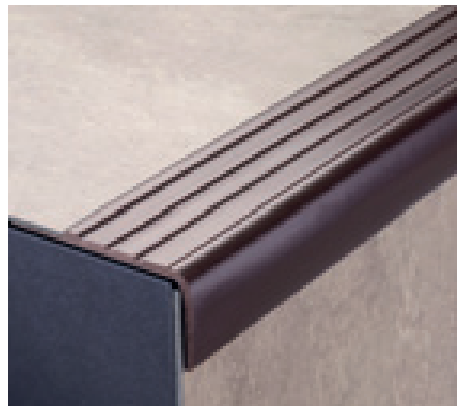

154 Brown PVC



155 Black PVC

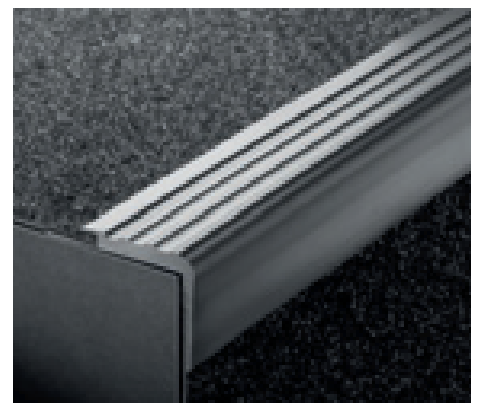

156 Grey PVC

All articles Protect in PVC should be stored horizontally

For a single piece, see sales conditions on page 288

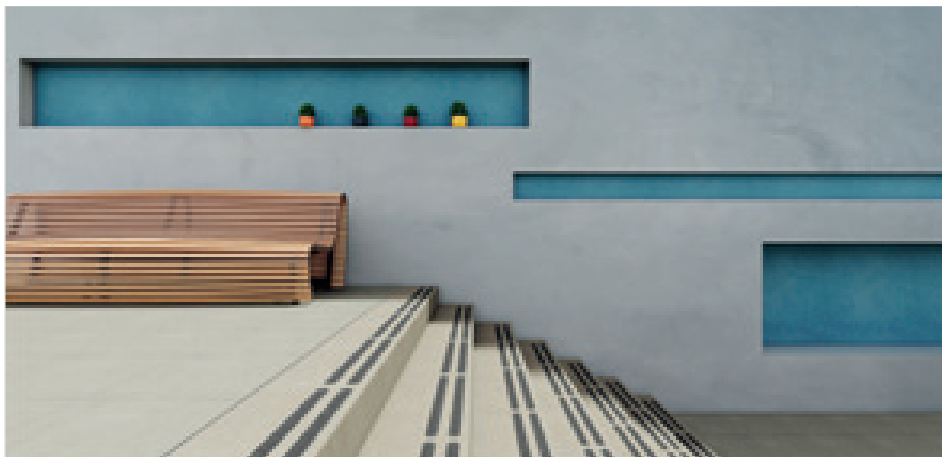

## safety-step

Slip -resistant strips Safety-Step: it is a line of anti-slip adhesive coverings consisting of abrasive particles aggregated by synthetic resins on dimensionally stable support. Suitable for all surfaces subjected to heavy traffic, both pedestrian and vehicular, such as stairs, hall of office and apartment buildings, ramps, walkways, elevators, platforms machinery, emergency exits etc..



Safety-Step - slip-resistant strip

### SAFETY-STEP - SLIP-RESISTANT STRIP

colour	width (mm)	length (cm)	code	euro/pc	pack
black	19	61	23000	1,73	50
black	25	61	23001	2,05	50
black	19	61	23100	9,03	10 pcs/ blister 
black	25	61	23101	10,29	10 pcs/ blister 
transparent	19	61	23016	1,73	50

no partial packaging - one blister contains 4 strips

### ADHESIVE FOR BORDERS

ml 140 - pack 12 pcs

output: 1 cartridge every 35 meters

#### ART.

H3502

23181

euro/pc

40,27

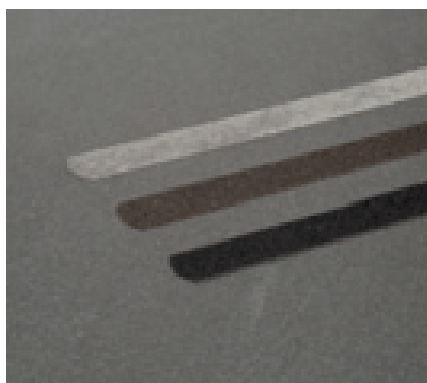

Safety-Step - slip-resistant strip



Safety-Step - slip-resistant roll

 packaging in blister no partial packaging

For a single piece, see sales conditions on page 288

Slip-resistant rolls Safety-Step: it is a line of anti-slip adhesive coverings consisting of abrasive particles aggregated by synthetic resins on dimensionally stable support. Suitable for all surfaces subjected to heavy traffic, both pedestrian and vehicular, such as stairs, hall of office and apartment buildings, ramps, walkways, elevators, platforms machinery, emergency exits etc.. The grey versions (Resilient Medium / Fine) consist of a rubber surface, and are perfect for areas of the walkway also barefoot such as showers, locker rooms, saunas, boats, sports equipment and etc...

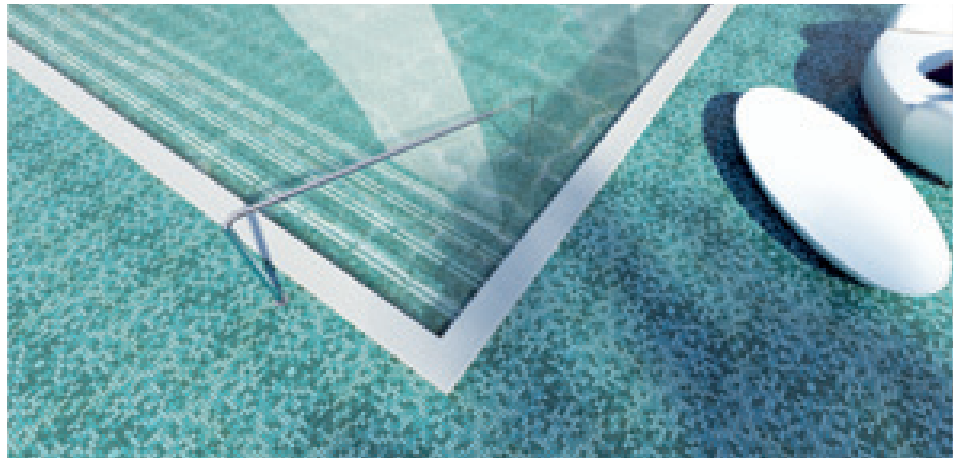

Safety-Step - slip-resistant roll

**SAFETY-STEP - SLIP-RESISTANT ROLL**

colour	width (mm)	length (cm)	code	euro/pc	pack
black	19	1820	23002	22,58	4
black	25	1820	23004	29,82	4
black	50	1820	23006	59,64	2
black	19	360	23103	6,62	10 pcs/blister
black	25	360	23105	8,09	10 pcs/blister
transparent	19	1820	23018	27,09	4
transparent	25	1820	23020	35,81	4
transparent	50	1820	23022	71,61	2
grey	25	1820	23044	91,46	4
grey	50	1820	23046	182,91	2

 packaging in blister no partial packaging

For a single piece, see sales conditions on page 288

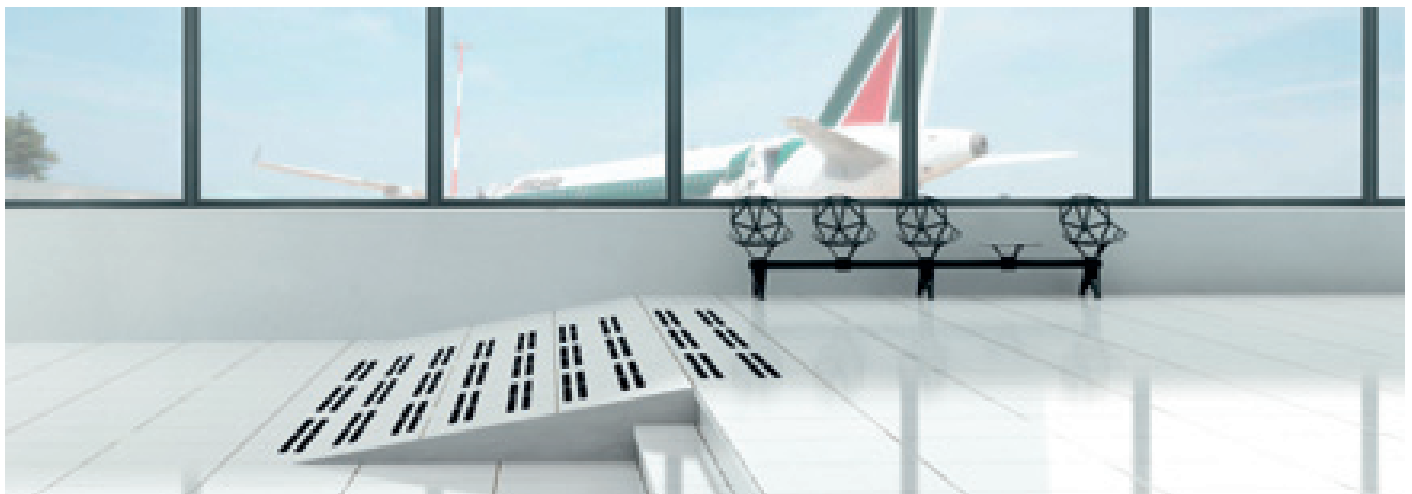

slip-resistant strip Safety-Step

## prostair

Prostair is a system composed of a profile and its relative accessories for the anchorage of stair rods on steps. The fixing accessories permit a quick removal of the stair rods for cleaning or replacement.

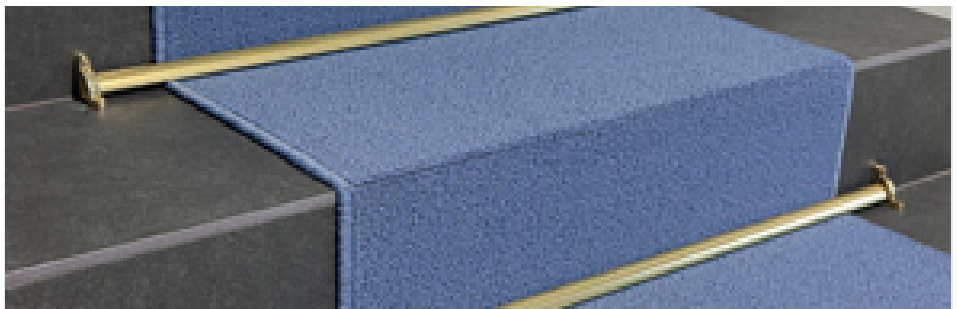

155/16 bright polished gold aluminium + 177/16

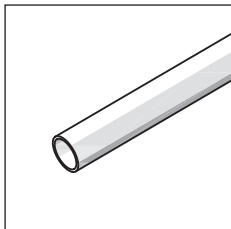

151/11

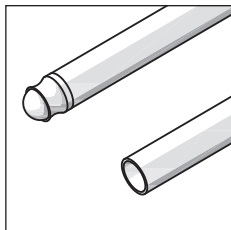

150/

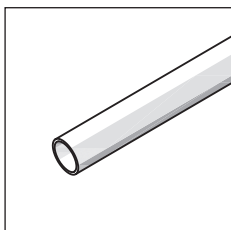

163/

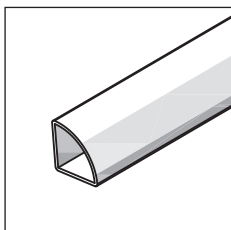

155/16

art. 163/ available in different lengths on request, extra €/pc 1,29

Complete the article code with the diameter measure (for example 150/ for diameter=11 becomes 150/11)

For a single piece, see sales conditions on page 288

### PROSTAIR

length = 380 cm - diameter 11 - pack 20 pcs

#### ART. finishing

#### ALUMINIUM

<b>151/11</b>	bright polished silver		78430
	<i>euro/m</i>		<b>6,56</b>

### PROSTAIR

pack 20 pcs

length cm **80** **90** **100** **120** **380**

#### ART. finishing

#### ALUMINIUM

		diameter					
		11	13	16	19	25	
	bright polished silver	78311	78312	78313	78314	78319	
		<i>euro/pc</i>	<b>8,80</b>	<b>9,47</b>	<b>10,12</b>	<b>11,42</b>	-
		<i>euro/m</i>	-	-	-	-	<b>6,56</b>
<b>150/</b>	bright polished gold	78321	-	78323	-	78329	
		<i>euro/pc</i>	<b>9,50</b>	-	<b>10,87</b>	-	-
		<i>euro/m</i>	-	-	-	-	<b>6,80</b>
		16			78339		
		<i>euro/m</i>	-	-	-	<b>7,61</b>	

pack 10 pcs / blister

<b>4150/11/S</b>	bright polished gold	11	21810	21811	21812	-	-
		<i>euro/blister</i>	<b>19,02</b>	<b>20,33</b>	<b>21,62</b>	-	-

articles 150/11, 150/13 and 150/16 of 380 cm partial packaging available and without knobs, for other articles no partial packaging - article 150/13 of 380 cm pack 40 pcs - article 150/16 of 380 cm pack 25 pcs

### PROSTAIR

		10 pcs	10 pcs	10 pcs
pack		10 pcs	10 pcs	10 pcs
length = 380 cm				
finishing				
BRASS		diameter		
		11	13	16
<b>163/</b>	polished	78801	78802	78803
		<i>euro/m</i>	<b>15,57</b>	<b>17,77</b>

### OTHER PROFILES

length = 300 cm - pack 20 pcs

#### ART. finishing

**16x16**

#### ALUMINIUM

<b>155/16</b>	bright polished gold		78379
	<i>euro/m</i>		<b>10,72</b>



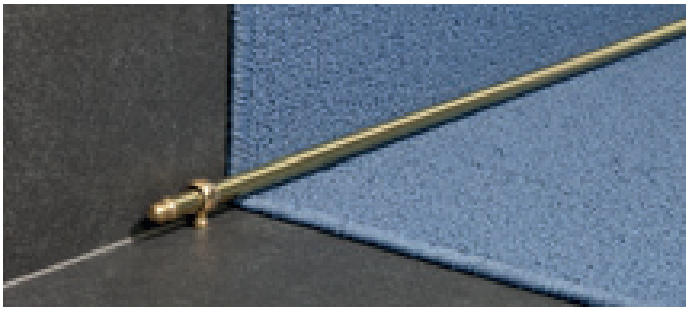

163/13 polished brass + 170/13



155/16 bright polished gold aluminium + 168/16 + 178/16

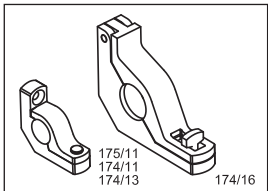

175/11 + 174/

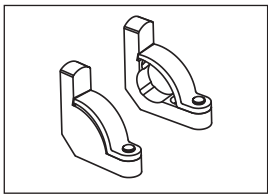

177/16

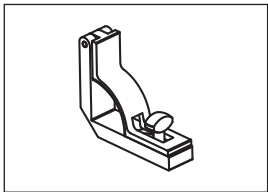

178/16

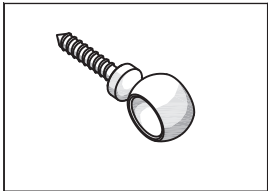

171/ + 170/

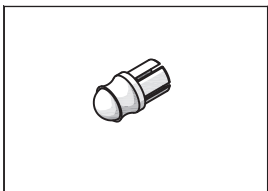

161/11 + 169/

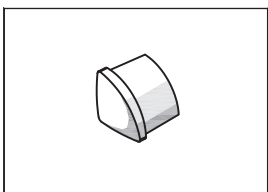

168/16

Complete the article code with diameter measure (eg. 174/ for diameter=11 becomes 174/11)

For a single piece, see sales conditions on page 288

**ACCESSORIES - BRACKETS**

pack 20 pcs		diameter		
ART.	finishing	11	13	16
<b>BRASS</b>				
175/11	chromium plated	78445	-	-
	<i>euro/pc</i>	11,64	-	-
pack 20 pcs				
174/	polished	78410	-	78412
	<i>euro/pc</i>	8,04	-	11,78
pack 10 couples 2 pcs dx/sx				
177/16	polished	-	-	78415
	<i>euro/couple</i>	-	-	27,45
pack 20 pcs		measures		
		16x16		
178/16	polished	78420		
	<i>euro/pc</i>	9,28		

**ACCESSORIES - RINGS**

pack 20 pcs		diameter		
ART.	finishing	11	13	16
<b>BRASS</b>				
171/11	chromium plated	78440	-	-
	<i>euro/pc</i>	4,27	-	-
pack 20 pcs				
170/	polished	78400	78401	78402
	<i>euro/pc</i>	2,50	2,75	4,29
10 blister packs/ 4 pcs/blister				
4170/ JS	polished	21852	-	-
	<i>euro/blister</i>	10,82	-	-
no partial packaging				

**ACCESSORIES - KNOBS**

pack 20 pcs		diameter		
ART.	finishing	11	13	16
<b>BRASS</b>				
161/11	chromium plated	78435	-	-
	<i>euro/pc</i>	2,64	-	-
pack 20 pcs				
169/	brass (for aluminium and brass profiles)	78395	78396	78397
	<i>euro/pc</i>	1,94	2,22	2,64
pack 20 pcs		16x16		
168/16	polished	78418		
	<i>euro/pc</i>	3,33		
no partial packaging				





## profiles for wooden, laminated and LVT floors

A full range of profiles for wooden, laminate and LVT floors. A series of systems and professional solutions proposed in different colours of anodised aluminium and in the exclusive finishes Alcrom® Plus, with the possibility of further customization thanks to PDS technology.

# profiles for wooden and laminate floors

## unisystem plus



Unisystem Plus is a system for the floating installation of wooden and laminate floors from 6,5 to 22,6 mm thickness. Composed of connection profiles for same and different level floors, perimetral profiles and stair nosing profiles, Unisystem Plus is easy to lay and simple to remove. The system is composed of a top profile, an aluminium base and a fixing clip: after inserting the fixing clip in the top profile, just push the top profile to fix it to the aluminium base.

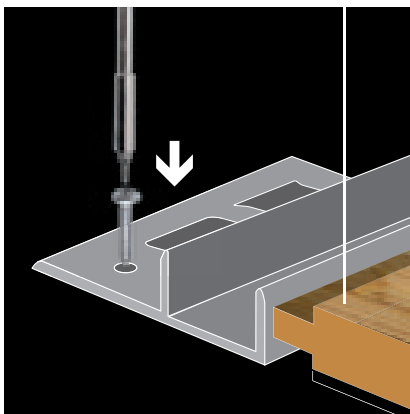

*fix the aluminium base to the subfloor with screws or glue*

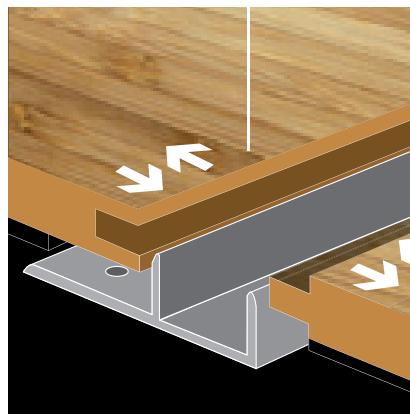

*bring the floor planks closer*

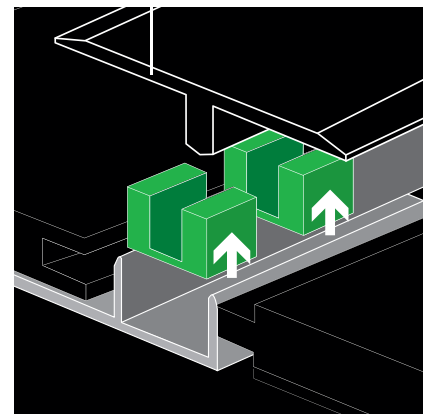

*insert the clips in the top profile*

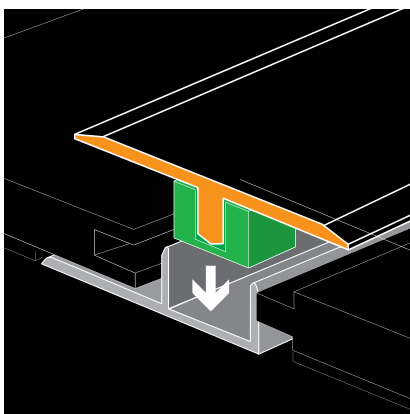

*put the top profile in the base*

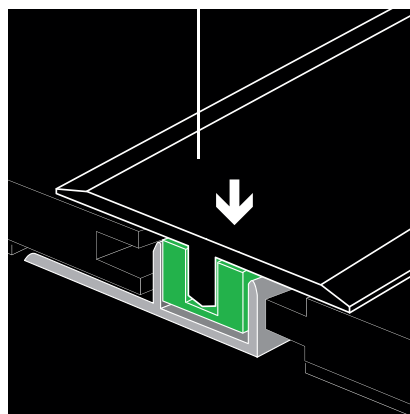

*push the top profile in the base*

Unisystem Plus line

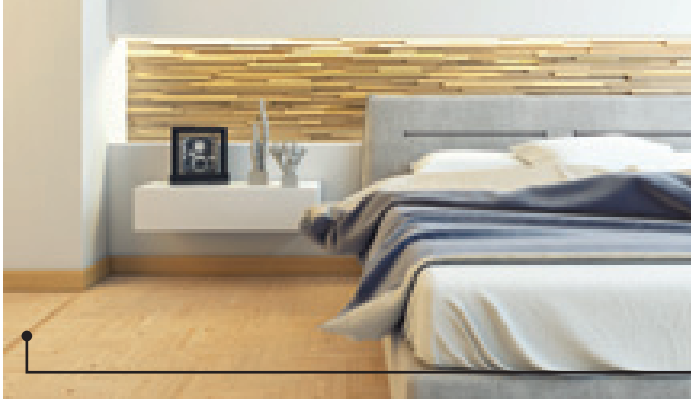

Connection profiles for floors of same level

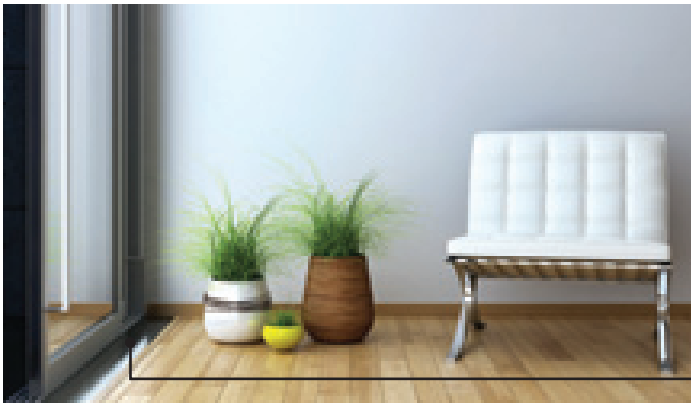

Connection profiles for floors of different level



Perimetral profiles

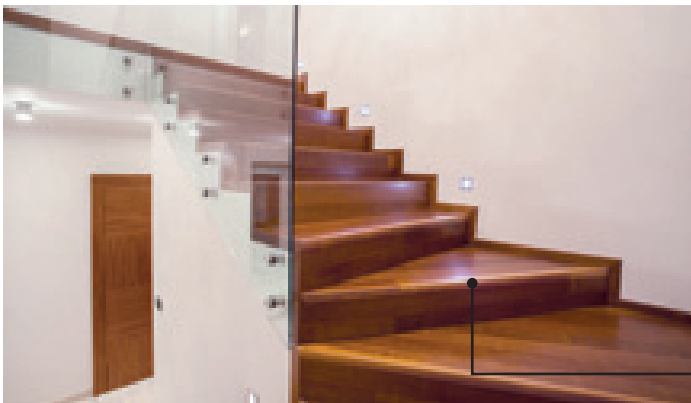

Stair nosing profiles



# unisystem - unisystem plus

Unisystem Plus is a system for the floating installation of wooden and laminate floors from 6,5 to 22,6 mm thickness, composed of junction profiles for same level floors (Z/ series), connection profiles for different level floors (C/ series) and perimetral profiles (S/ series). The system is composed of a natural aluminium base and a top profile to be fixed on the base through a specific clip. The top profile is available in different finishes of anodised aluminium or covered with wood-effect Alcrom® Plus film for matching the floor perfectly.



Unisystem Plus Z/1/SF, C/7/SF e S/9/SF

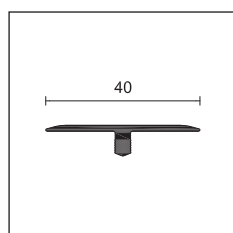

Z/1/SF

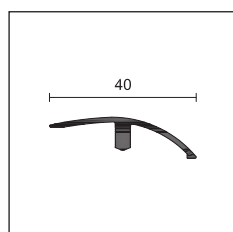

C/7/SF

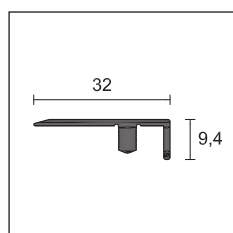

S/9/SF

## UNISYSTEM/ UNISYSTEM PLUS

length = 270 cm - pack 10 pcs

ART.	finishing	Z/1/SF	C/7/SF	S/9/SF
floor thickness from / to mm				
		6,5/22,6	6,5/10	6,5/22,6
<b>ALUMINIUM covered with ALCROM® PLUS film</b>				
02		66301	66001	65701
05		66306	66006	65706
08		66304	66004	65704
10		66307	66007	65707
11		66308	66008	65708
12		66309	66009	65709
13		66310	66010	65710
14		66311	66011	65711
18		66316	66016	65716
19		66318	66018	65718
20		66317	66017	65717
26		66321	66021	65721
31		66328	66028	65728
32		66329	66029	65729
34		66331	66031	65731
35		66332	66032	65732
36		66333	66033	65733
37		66334	66034	65734
38		66335	66035	65735
39		66336	66036	65736
40		66337	66037	65737
41		66338	66038	65738
42		66339	66039	65739
43		66340	66040	65740
44		66341	66041	65741
47		66344	66044	65744
65		66365	66065	65765
71		66368	66068	65768
72		66369	66069	65769
73		66370	66070	65770
74		66371	66071	65771
76		66374	66074	65774
77		66372	66072	65772
78		66376	66076	65776
79		66373	66073	65773
80		66377	66077	65777
81		66378	66078	65778
89		66386	66086	65784

euro/m

11,43

individually packed

## UNISYSTEM/ UNISYSTEM PLUS

length = 270 cm - pack 10 pcs

ART.	finishing	Z/1/SF	C/7/SF	S/9/SF
floor thickness from / to mm				
		6,5/22,6	6,5/10	6,5/22,6
<b>ALUMINIUM covered with ALCROM® PLUS film</b>				
91		66388	66088	65786
92		66389	66089	65789
93		66390	66090	65790
94		66391	66091	65791
95		66392	66092	65792
351		66393	66093	-
363		66394	66094	-
372		66395	66095	-
490		66397	66097	-
560		66398	66098	-
580		66399	66099	65793
590		66400	66100	-
665		66401	66101	65794
670		66402	66102	65795
951		66408	66108	65797
975		66409	66109	65798
1024		66410	66110	65799
1033		66411	66111	65800
1042		66412	66112	65801
1090		66414	66114	65803
1202		66416	66116	65805
1203		66417	66117	65806
1204		66418	66118	65807
1205		66419	66119	65808
1206		66420	66120	65809
1207		66421	66121	65810
1208		66422	66122	65811
1209		66423	66123	65812
1210		66424	66124	65813
1211		66425	66125	65814
1212		66426	66126	65815
1213		66427	66127	65816
1214		66428	66128	65817
1215		66429	66129	65818
1216		66430	66130	65819
1217		66431	66131	65820
100		66432	66132	-
NEW	black 97	66433	66133	65821

euro/m

11,43

individually packed

For a single piece, see sales conditions on page 288





Profiles of 270 cm length: please order the base separately.

Customized PDS decors on request, see page 195

unisystem - unisystem plus

**UNISYSTEM/ UNISYSTEM PLUS**

length = 270 cm - pack 20 pcs

ART.	finishing	Z/1/SF	C/7/SF	S/9/SF
floor thickness from / to mm		6,5/22,6	6,5/10	6,5/22,6
<b>ANODISED ALUMINIUM</b>				
silver		67217	67007	65680
gold		67227	67017	65685
gold sand		67234	67024	65688
bronze		67237	67027	65690
<i>euro/m</i>		<b>6,86</b>	<b>6,86</b>	<b>6,86</b>
titanium		67238	67000	65691
<i>euro/m</i>		<b>7,49</b>	<b>7,49</b>	<b>7,49</b>

Other models for thicker floors available on page 176 individually packed

**UNISYSTEM PLUS - BASES**

floor thickness from / to mm		6,5/10	9,6/12,5	12,6/15,5	15/19	19,6/22,6	
length = 270 cm pack 20 pcs (15 clips TU/6 included)		<b>H</b>					
ART.	finishing	<b>6</b>	<b>10</b>	<b>13</b>	<b>15</b>	<b>22</b>	
<b>ALUMINIUM</b>							
<b>TPU/</b>	natural aluminium		67437	67447	67457	67460	67467
	<i>euro/m</i>		<b>4,71</b>	<b>5,26</b>	<b>5,74</b>	<b>6,41</b>	<b>8,37</b>

individually packed (art. TPU/22 pack 10 pcs)

**SPARE CLIPS**

pack of 150 pcs

		<b>H</b>				
		<b>6</b>				
<b>TU/6</b>		68812/150				
<i>euro/pack</i>		<b>22,42</b>				

no partial packaging

**UNISYSTEM - BASES**

floor thickness from / to mm		6,5/10	10,12	6,5/10	13/15	11/15	
length = 270 cm - pack 20 pcs		<b>H</b>					
ART.	finishing	<b>7</b>	<b>10</b>	<b>11</b>	<b>13</b>	<b>15</b>	
<b>ALUMINIUM</b>							
<b>T/</b>	natural aluminium		67287	67297	67317	67307	67327
	<i>euro/m</i>		<b>4,71</b>	<b>5,26</b>	<b>4,67</b>	<b>5,74</b>	<b>5,30</b>

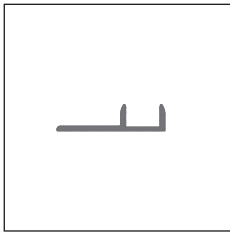

TPU/

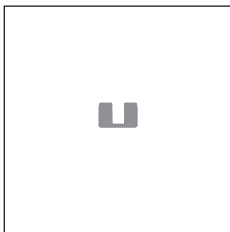

TU/6

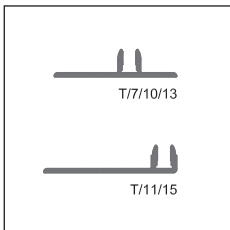

T/



Z/1/SF aluminium covered with Alcrom® Plus film



C/7/SF aluminium covered with Alcrom® Plus film



S/9/SF aluminium covered with Alcrom® Plus film

# unisystem - unisystem plus

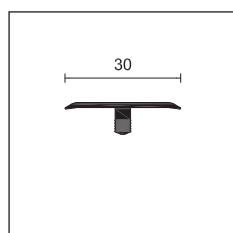

Z3/30/SF

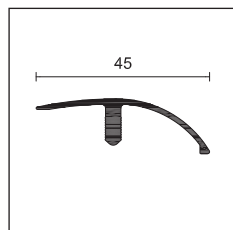

C/10/SF

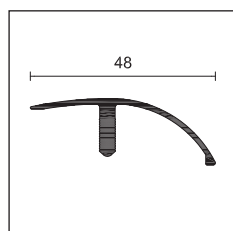

C/13/SF

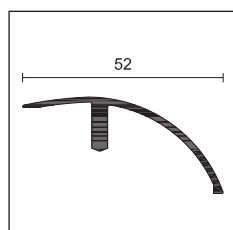

C/22/SF

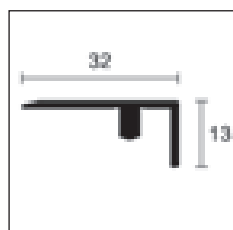

S/15/SF

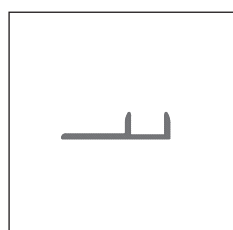

TPU/

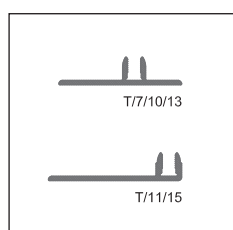

T/

## UNISYSTEM - UNISYSTEM PLUS

length = 270 cm	pack 20 pcs	pack 20 pcs	pack 10 pcs	pack 10 pcs	pack 10 pcs	
<b>ART.</b>	<b>finishing</b>	<b>Z3/30/SF</b>	<b>C/10/SF</b>	<b>C/13/SF</b>	<b>C/22/SF</b>	<b>S/15/SF</b>
floor thickness from / to mm		6,5/22,6	9,6/12,5	12,6/15,5	15/22,6	9,6/22,6
<b>ANODISED ALUMINIUM</b>						
silver		63700	67077	67147	66907	65480
gold		63702	67087	67157	-	-
gold sand		63704	-	-	-	65488
<b>euro/m</b>		<b>6,42</b>	<b>7,76</b>	<b>9,04</b>	<b>14,83</b>	<b>7,18</b>

individually packed

## UNISYSTEM PLUS - BASES

floor thickness from / to mm	6,5/10	9,6/12,5	12,6/15,5	15/19	19,6/22,6	
length = 270 cm pack 20 pcs (15 clips TU/6 included)	<b>H</b>					
<b>ART.</b>	<b>6</b>	<b>10</b>	<b>13</b>	<b>15</b>	<b>22</b>	
<b>ALUMINIUM</b>						
<b>TPU/</b> natural aluminium		67437	67447	67457	67460	67467
<b>euro/m</b>		<b>4,71</b>	<b>5,26</b>	<b>5,74</b>	<b>6,41</b>	<b>8,37</b>

individually packed (art. TPU/22 pack 10 pcs)

## SPARE CLIPS

pack da 150 pcs	H
	<b>6</b>
<b>TU/6</b>	68812/150
<b>euro/pack</b>	<b>22,42</b>

no partial packaging

## UNISYSTEM - BASES

floor thickness from / to mm	6,5/10	10/12	6,5/10	13/15	11/15	
length = 270 cm - pack 20 pcs	<b>H</b>					
<b>ART.</b>	<b>7</b>	<b>10</b>	<b>11</b>	<b>13</b>	<b>15</b>	
<b>ALUMINIUM</b>						
<b>T/</b> natural aluminium		67287	67297	67317	67307	67327
<b>euro/m</b>		<b>4,71</b>	<b>5,26</b>	<b>4,67</b>	<b>5,74</b>	<b>5,30</b>



Customized PDS decors on request, see page 195

For a single piece, see sales conditions on page 288

Z3/30/SF silver anodised aluminium



unisystem - unisystem plus

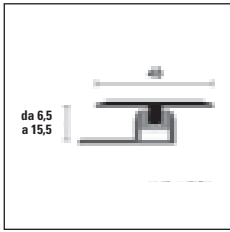

TPZ/

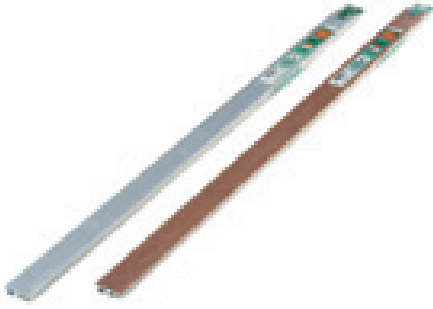

TPZ/47/CV silver anodised aluminium and aluminium covered with Alcrom® Plus film

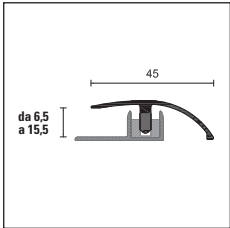

TPC/

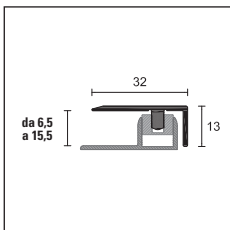

TPS/

The blister pack contains base, clips and profile.

**UNISYSTEM PLUS**

length = 90 cm - pack 10 pcs / blister - for floor thicknesses from 6,5 to 10 mm

**ART. finishing**

**ALUMINIUM covered with ALCROM® PLUS film**

	05	43005		77	43011		1208	43027
	10	43020		78	43066		1209	43029
	14	43006		80	43068		1210	43030
	19	43007		89	43012		1211	43031
	20	43028		91	43013		1212	43033
<b>TPZ/47/CV</b>	26	43008		580	43014		1213	43035
	31	43009		1202	43016		1214	43037
	38	43034		1203	43017		1215	43039
	39	43010		1204	43018		1216	43041
	40	43036		1205	43019		1217	43043
	42	43038		1206	43025			
	65	43056		1207	43026			
<b>euro/pc</b>								<b>15,96</b>

individually packed

**UNISYSTEM PLUS**

length = 90 cm - pack 10 pcs / blister

**ART. finishing**

	<b>TPZ/47/CV</b>	<b>TPZ/410/CV</b>	<b>TPZ/413/CV</b>
floor thickness from / to mm	6,5 / 10	9,6 / 12,5	12,6 / 15,5
<b>ANODISED ALUMINIUM</b>			
silver	43000	43072	43144
gold	43004	43076	43148
<b>euro/pc</b>	<b>11,85</b>	<b>12,36</b>	<b>12,81</b>

individually packed

**UNISYSTEM PLUS**

length = 90 cm - pack 10 pcs / blister - for floor thicknesses from 6,5 to 10 mm

**ART. finishing**

**ALUMINIUM covered with ALCROM® PLUS film**

	05	43219		77	43225		1208	43239
	10	43234		78	43280		1209	43240
	14	43220		80	43282		1210	43241
	19	43221		89	43226		1211	43243
	20	43242		91	43227		1212	43244
<b>TPC/47/CV</b>	26	43222		580	43228		1213	43245
	31	43223		1202	43231		1214	43247
	38	43248		1203	43232		1215	43249
	39	43224		1204	43233		1216	43251
	40	43250		1205	43235		1217	43253
	42	43252		1206	43236			
	65	43270		1207	43237			
<b>euro/pc</b>								<b>15,96</b>

individually packed

**UNISYSTEM PLUS**

length = 90 cm - pack 10 pcs / blister

**ART. finishing**

	<b>TPC/47/CV</b>	<b>TPC/410/CV</b>	<b>TPC/413/CV</b>
floor thickness from / to mm	6,5 / 10	9,6 / 12,5	12,6 / 15,5
<b>ANODISED ALUMINIUM</b>			
silver	43214	43286	43358
gold	43218	43290	43362
<b>euro/pc</b>	<b>11,85</b>	<b>12,59</b>	<b>13,83</b>

individually packed

**UNISYSTEM PLUS**

length = 90 cm - pack 10 pcs / blister

**ART. finishing**

	<b>TPS/47/CV</b>	<b>TPS/410/CV</b>	<b>TPS/413/CV</b>
floor thickness from / to mm	6,5 / 10	9,6 / 12,5	12,6 / 15,5
<b>ANODISED ALUMINIUM</b>			
silver	43430	43502	43574
<b>euro/pc</b>	<b>11,85</b>	<b>12,88</b>	<b>13,32</b>

individually packed

# unisystem plus

G/2/SF is a stair nosing profile of Unisystem Plus line. Composed of a base and a top profile, it is suitable for the installation of floating wooden and laminate with thicknesses from 6,5 to 12,5 mm.

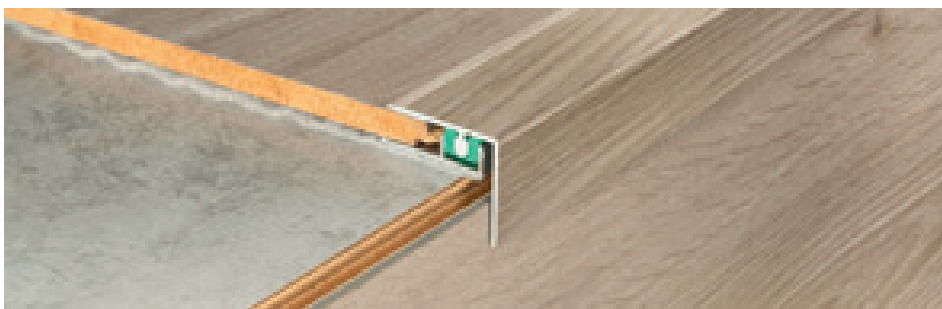

G/2/SF aluminium covered with Alcrom® Plus film

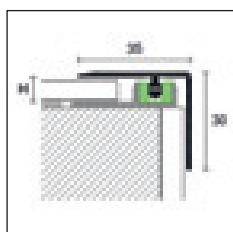

G/2/SF + TPU/

### UNISYSTEM PLUS

length = 270 cm - pack 10 pcs - for floor thicknesses from 6,5 to 12,5 mm

#### ART. finishing

#### ALUMINIUM covered with ALCROM® PLUS film

	05	43645		41	43656		1207	43668
	08	43646		77	43657		1208	43669
	12	43647		89	43658		1209	43670
	13	43648		91	43659		1210	43671
	14	43649		93	43660		1211	43672
<b>G/2/SF</b>	19	43650		580	43661		1212	43673
	26	43651		1202	43663		1213	43674
	32	43652		1203	43664		1214	43675
	36	43653		1204	43665		1215	43676
	39	43654		1205	43666		1216	43677
	40	43655		1206	43667		1217	43678
	<b>euro/m</b>				<b>12,11</b>			

individually packed

### UNISYSTEM PLUS

length = 270 cm - pack 10 pcs - for floor thicknesses from 6,5 to 12,5 mm

#### ART. finishing

#### ANODISED ALUMINIUM

	silver		43690
<b>G/2/SF</b>	<b>euro/m</b>		<b>7,22</b>
	titanium		43691
	<b>euro/m</b>		<b>7,85</b>

individually packed

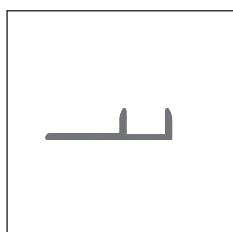

TPU/

### UNISYSTEM PLUS - BASES

floor thickness from / to mm 6,5/10 9,6/12,5

length = 270 cm - pack 20 pcs (15 clips TU/6 included)

#### ART. finishing

#### ALUMINIUM

		6	10
<b>TPU/</b>	natural aluminium	67437	67447
	<b>euro/m</b>	<b>4,71</b>	<b>5,26</b>

individually packed

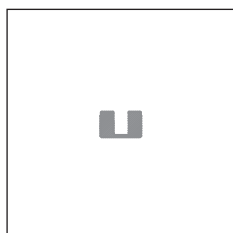

TU/6

### SPARE CLIPS

pack 150 pcs

	H
	6
<b>TU/6</b>	68812/150
<b>euro/pack</b>	<b>22,42</b>

no partial packaging

For a single piece, see sales conditions on page 288

Customized PDS decors on request, see page 195

Profiles of 270 cm length: please order the base separately.

G/4/SF is a stair nosing profile of Unisystem Plus range, composed of a base and a top profile, for the floating installation of wooden and laminate floors with thicknesses from 6,5 to 15,5 mm.



G/4/SF aluminium covered with Alcrom® Plus film

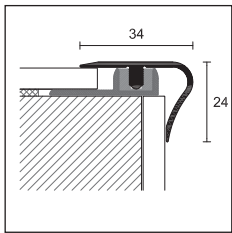

G/4/SF + TPU/

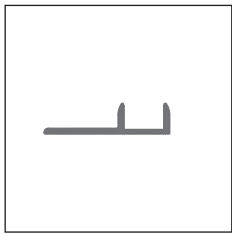

TPU/

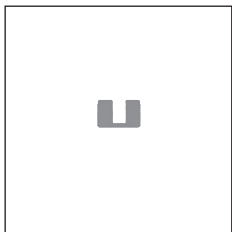

TU/6

**UNISYSTEM PLUS**

length = 270 cm - pack 10 pcs - for floor thicknesses from 6,5 to 15,5 mm

**ART. finishing**

**ALUMINIUM covered with ALCROM® PLUS film**

	02	63905		37	63943		76	63956
	08	63907		38	63919		77	63937
	10	63910		40	63920		78	63934
	11	63911		41	63926		79	63938
	12	63913		42	63921		80	63935
<b>G/4/SF</b>	13	63916		43	63927		81	63939
	18	63914		44	63929		92	63941
	20	63915		65	63931		93	63944
	32	63917		71	63951		94	63945
	34	63923		72	63952		95	63946
	35	63924		73	63953			
	36	63942		74	63954			
	<b>euro/m</b>				<b>12,10</b>			

individually packed

**UNISYSTEM PLUS**

length = 270 cm - pack 10 pcs - for floor thicknesses from 6,5 to 15,5 mm

**ART. finishing**

**ANODISED ALUMINIUM**

<b>G/4/SF</b>	silver		63900
	gold sand		63904
	<b>euro/m</b>		<b>7,18</b>

individually packed

**UNISYSTEM PLUS - BASES**

floor thickness from / to mm	6,5/10	9,6/12,5	12,6/15,5	
length = 270 cm pack 20 pcs (15 clips TU/6 included)		<b>H</b>		
<b>ART. finishing</b>	<b>6</b>	<b>10</b>	<b>13</b>	
<b>ALUMINIUM</b>				
<b>TPU/</b>	natural aluminium	67437	67447	67457
	<b>euro/m</b>	<b>4,71</b>	<b>5,26</b>	<b>5,74</b>

individually packed

**SPARE CLIPS**

pack da 150 pcs	<b>H</b>
	<b>6</b>
<b>TU/6</b>	68812/150
<b>euro/pack</b>	<b>22,42</b>

no partial packaging

For a single piece, see sales conditions on page 288

Profiles of 270 cm length: please order the base separately.

Customized PDS decors on request, see page 195

# profix thin

Profix Thin is a system for the floating installation of LVT floors from 4 to 8 mm thickness, composed of junction profiles for same level floors (Z/4), connection profiles for different level floors (C/4) and perimetral profiles (S/4). The system is composed of a PVC base and a top profile available in different finishes of anodised aluminium or covered with wood-, stone- or concrete-effect Alcrom® Plus film for matching the floor perfectly.

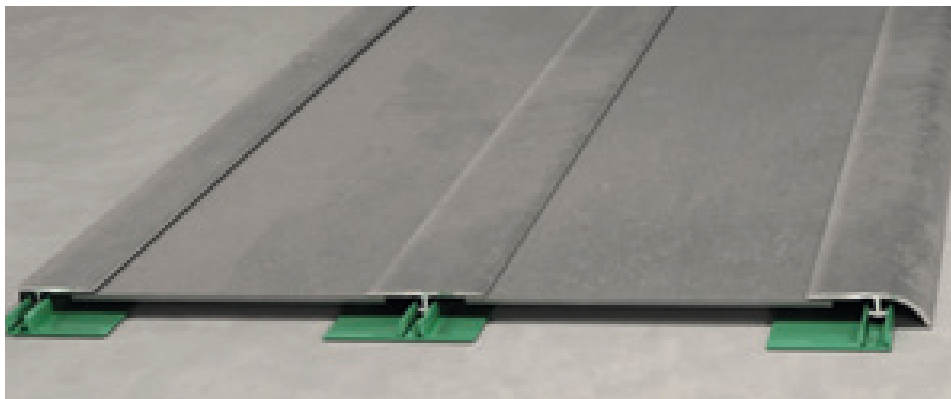

Profix Thin Z/4, C/4 e S/4

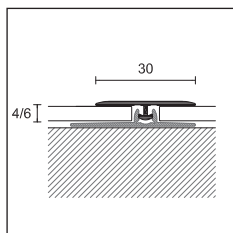

Z/4 + PT/4

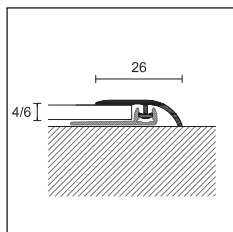

C/4 + PT/4/SA

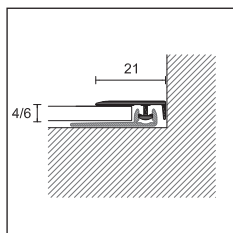

S/4 + PT/4/SA

### PROFIX THIN

length = 270 cm - pack 20 pcs

for floor thickness (from 4 to 8 mm)

#### ALUMINIUM covered with ALCROM® PLUS film

	Z/4	C/4	S/4
1003	85101	85201	85301
1006	85102	85202	85302
1009	85103	85203	85303
1012	85104	85204	85304
1021	85107	85207	85307
1024	85108	85208	85308
1030	85110	85210	85310
1033	85111	85211	85311
1036	85112	85212	85312
1042	85114	85214	85314
1045	85115	85215	85315
1051	85117	85217	85317
1054	85118	85218	85318
1057	85119	85219	85319
1060	85120	85220	85320
1063	85121	85221	85321
1066	85122	85222	85322
1069	85123	85223	85323
1081	85127	85227	85327
1084	85128	85228	85328
1090	85130	85230	85330
1105	85135	85235	85335
1108	85136	85236	85336
1111	85137	85237	85337
<b>euro/m</b>	<b>5,41</b>	<b>5,41</b>	<b>5,41</b>

individually packed

### PROFIX THIN

length = 270 cm - pack 20 pcs

for floor thickness (from 4 to 8 mm)

ART.	Z/4	C/4	S/4
<b>finishing</b>			
<b>ANODISED ALUMINIUM</b>			
silver	85050	85060	85070
<b>euro/m</b>	<b>3,23</b>	<b>3,23</b>	<b>3,23</b>
gold sand	85052	85062	85072
titanium	85054	85064	85074
<b>euro/m</b>	<b>3,59</b>	<b>3,59</b>	<b>3,59</b>
bronze elox	85056	85066	85076
<b>euro/m</b>	<b>3,86</b>	<b>3,86</b>	<b>3,86</b>

Customized PDS decors on request, see page 195

For a single piece, see sales conditions on page 288

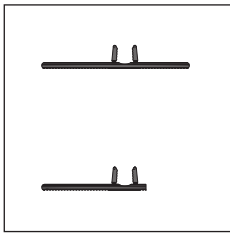

PT/4  
PT/4/SA

**PROFIX THIN - BASES**

length = 270 cm - pack 20 pcs

for floor thickness (from 4 to 6 mm)

ART.	PT/4	PT/4/SA
finishing		
PVC		
green	85081	85083
euro/m	1,54	1,53

To order PT/4 and PT/4/SA in pack of 100 pcs mark /100 after the article code (for example code 85081 becomes 85081/100). Pack of 100 pcs of PT/4 and PT/4/SA €/m 1,27

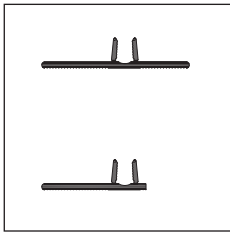

PT/6  
PT/6/SA

**PROFIX THIN - BASES**

length = 270 cm - pack 20 pcs

for floor thickness (from 6 to 8 mm)

ART.	NEW PT/6	NEW PT/6/SA
finishing		
PVC		
green	85086	85088
euro/m	1,54	1,53

To order PT/6 and PT/6/SA in pack of 100 pcs mark /100 after the article code (for example code 85086 becomes 85086/100). Pack of 100 pcs of PT/6 and PT/6/SA €/m 1,27

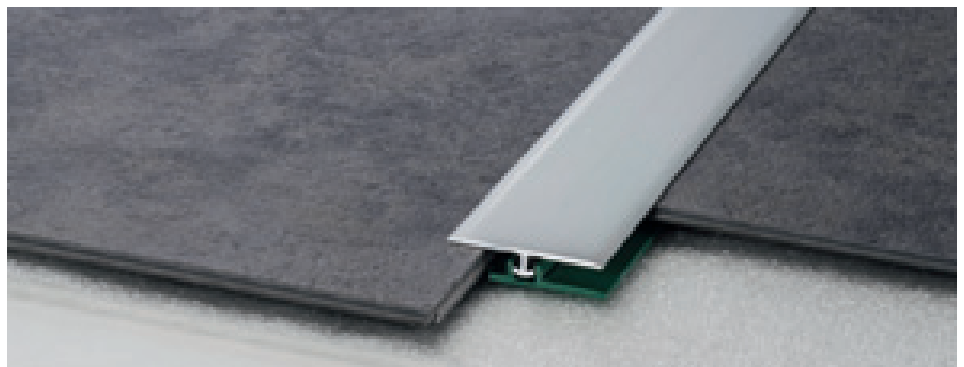

Z/4 + PT/4

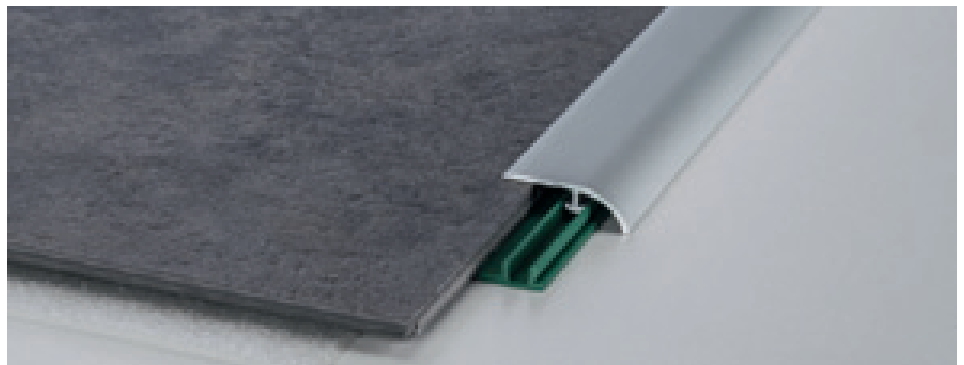

C/4 + PT/4/SA

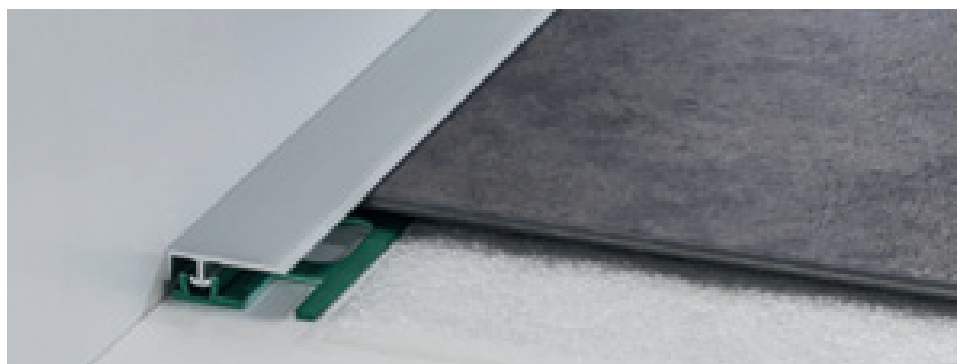

S/4 + PT/4/SA

# prestowood

Prestowood 22/A, 50/A and 63/A are adhesive profiles for wooden floors of same level, different level and stairs that have been already installed. In anodised aluminium, or covered with Alcrom® Plus film, they are particularly easy and quick to install, thus becoming suitable also for the DIY.



22/A aluminium covered with Alcrom® Plus film

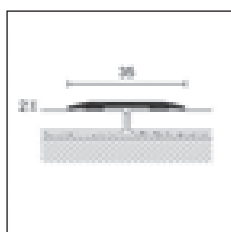

422/AD  
22/A

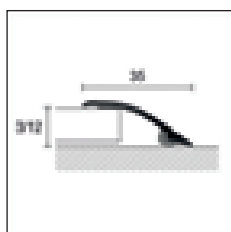



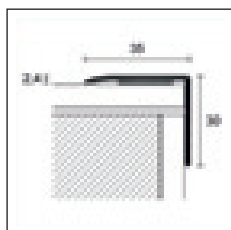





































450/AD  
50/A



63/A

## PRESTOWOOD

pack	10 pcs / blister 	10 pcs	10 pcs / blister 	10 pcs	10 pcs	
length cm	90	270	90	270	270	
ART.	422/AD	22/A	450/AD	50/A	63/A	
<b>ALUMINIUM covered with ALCROM® PLUS film</b>						
	05	43700	43932	44949	45031	45140
	08	43701	43933	44950	45032	45141
	12	43702	43934	44951	45033	45142
	13	43703	43935	44952	45034	45143
	14	43704	43936	44953	45035	45144
	19	43705	43937	44954	45036	45145
	26	43706	43938	44955	45037	45146
	31	43707	43939	44956	45038	-
	32	43708	43940	44957	45039	45147
	34	43709	43941	44958	45040	-
	36	43710	43942	44959	45041	45148
	39	43711	43943	44960	45042	45149
	40	43712	43944	44961	45043	45150
	41	43713	43945	44962	45044	45151
	73	43714	43946	44963	45045	-
	74	43715	43947	44964	45046	-
	77	43716	43948	44965	45047	45152
	79	43717	43949	44966	45048	-
	81	43718	43950	44967	45049	-
	89	43719	43951	44968	45050	45153
	91	43720	43952	44969	45051	45154
	92	43721	43953	44970	45052	-
	93	43762	43995	45013	45094	45155
	94	43722	43954	44971	45053	-
	351	43723	43955	44972	45054	-
	363	43724	43956	44973	45055	-
	372	43725	43957	44974	45056	-
	490	43727	43959	44976	45058	-
	560	43728	43960	44977	45059	-
	580	43729	43961	44978	45060	45156
	590	43730	43962	44979	45061	-
	665	43731	43963	44980	45062	-
	670	43732	43964	44981	45063	-
	951	43738	43970	44987	45069	-
	975	43739	43971	44988	45070	-
	1024	43740	43972	44989	45071	-
	1033	43741	43973	44990	45072	-
	1042	43742	43974	44991	45073	-
	1090	43744	43976	44993	45075	-

 packaging in blister no partial packaging

422/AD, 450/AD and 63/A are available just for Spain and Portugal

Customized PDS decors on request, see page 195

For a single piece, see sales conditions on page 288

pack	10 pcs / blister	10 pcs	10 pcs / blister	10 pcs	10 pcs
length cm	90	270	90	270	270
ART.	422/AD	22/A	450/AD	50/A	63/A
<b>ALUMINIUM covered with ALCROM® PLUS film</b>					
	1202	43746	43978	44995	45077
	1203	43747	43979	44996	45078
	1204	43748	43980	44997	45079
	1205	43749	43981	44998	45080
	1206	43750	43982	44999	45081
	1207	43751	43983	45000	45082
	1208	43752	43984	45001	45083
	1209	43753	43985	45002	45084
	1210	43754	43986	45003	45085
	1211	43755	43987	45004	45086
	1212	43756	43988	45005	45087
	1213	43757	43989	45007	45088
	1214	43758	43990	45008	45089
	1215	43759	43991	45009	45090
	1216	43760	43992	45010	45091
	1217	43761	43993	45011	45092
	100	-	43994	-	45093
	black 97	-	43996	-	45095
<b>euro/pc</b>	<b>8,74</b>	-	<b>8,74</b>	-	-
<b>euro/m</b>	-	<b>8,13</b>	-	<b>8,13</b>	<b>10,43</b>

NEW

individually packed

**PROCLASSIC F / PROLEVEL HIGH / PROTECT**

pack	10 pcs / blister	10 pcs	10 pcs / blister	10 pcs	10 pcs
length cm	90	270	90	270	270
ART.	422/AD	22/A	450/AD	50/A	63/A
<b>ANODISED ALUMINIUM</b>					
	silver	43790	44000	45019	45100
<b>euro/pc</b>	<b>6,43</b>	-	<b>6,43</b>	-	-
<b>euro/m</b>	-	<b>5,58</b>	-	<b>5,58</b>	<b>7,64</b>
	titanium	43791	44001	45020	45101
<b>euro/pc</b>	<b>7,28</b>	-	<b>7,28</b>	-	-
<b>euro/m</b>	-	<b>6,55</b>	-	<b>6,55</b>	<b>8,61</b>

individually packed



50/A titanium anodised aluminium



63/A silver anodised aluminium

# prestowood

Prestowood 74/A is a line of stair nosing profiles covered with wood-effect Alcrom® Plus film, for the protection of already-laid wooden step edges. Available in adhesive version, they are particularly recommended for DIY installations.

74/ is also available in different finishes of anodised aluminium, as the stair nosing profiles 73/ and 58/.



74/A aluminium covered with Alcrom® Plus film

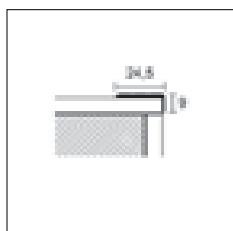

73/

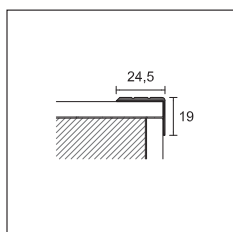

74/

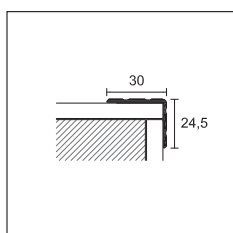

58/A

## PRESTOWOOD

pack			10 pcs
length cm			270
<b>ART.</b>			<b>74/A</b>
<b>finishing</b>			
<b>ALUMINIUM covered with ALCROM® PLUS film</b>			
	10	75319	
	12	75297	
	13	75301	
	20	75320	
	32	75303	
	36	75304	
	37	75305	
	38	75306	
	40	75322	
	47	75307	
	65	75294	
	71	75309	
	76	75334	
	78	75311	
	80	75326	
	92	75312	
	94	75313	
	95	75314	
<b>euro/m</b>		<b>10,29</b>	

individually packed

## PROTECT

pack	30 pcs						20 pcs	
length cm	270							
<b>ART.</b>	<b>73/</b>			<b>74/</b>			<b>58/</b>	
<b>finishing</b>	<b>F</b>	<b>SF</b>	<b>A</b>	<b>F</b>	<b>SF</b>	<b>A</b>	<b>A</b>	
<b>ALUMINIUM</b>								
silver anodised		75208	75209	75238	75268	75269	75298	75900
gold anodised		75218	-	75248	75278	-	75308	-
bronze anodised		-	-	75258	-	-	75318	-
<b>euro/m</b>		<b>3,84</b>	<b>3,69</b>	<b>5,06</b>	<b>4,41</b>	<b>4,26</b>	<b>5,63</b>	<b>6,25</b>
titanium anodised							75299	
<b>euro/m</b>							<b>7,15</b>	

Customized PDS decors on request, see page 195

For a single piece, see sales conditions on page 288



RC is a line of edge profiles for the floating installation of wooden and laminate floors, available in different finishes of anodised aluminium or covered with wood-effect Alcrom® Plus film. This profile is also available in the bendable version RCF that can be curved with the specific Proflex Machine.

Prolevel High 732/ is a line of profiles for the protection of the perimetral border of wooden and laminate floors.



RC/9/F silver anodised aluminium

**RC**

length = 270 cm - pack 20 pcs

ART.	finishing	7	9	11	13	15
<b>ALUMINIUM</b>						
	silver anodised	67407	67477	67547	67617	67687
<b>RC/ /F</b>	gold anodised	-	67487	-	-	-
	bronze anodised	-	67497	-	-	-
<b>euro/m</b>		<b>4,91</b>	<b>4,98</b>	<b>5,17</b>	<b>5,45</b>	<b>5,63</b>

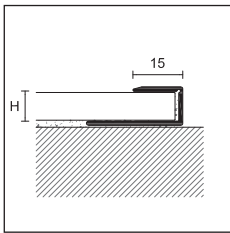

RC/ /F  
RCF/

length = 270 cm - pack 10 pcs

ART.	finishing	7	9	11	13	15
<b>ALUMINIUM covered with ALCROM® PLUS film</b>						
	10	-	66731	-	-	-
	20	-	66734	-	-	-
	38	-	66739	-	-	-
<b>RC/ /F</b>	40	-	66740	-	-	-
	42	-	66758	-	-	-
	65	-	66747	-	-	-
	78	-	66751	-	-	-
	80	-	66752	-	-	-
<b>euro/m</b>		-	<b>6,98</b>	-	-	-



RCF/ silver anodised aluminium

**RC**

length = 90 cm - pack 10 pcs / blister

ART.	finishing	7	9	11	15
<b>ALUMINIUM</b>					
	silver anodised	42782	41832	41877	42822
	gold anodised	-	41839	-	-
<b>euro/pc</b>		<b>5,81</b>	<b>5,87</b>	<b>6,07</b>	<b>6,47</b>

**PRO FLEX LINE**

**TERMINAL FLEX**

length = 270 cm - pack 10 pcs

ART.	finishing	7	9	11	15	22,5
<b>ALUMINIUM</b>						
<b>RCF/</b>	silver anodised	67710	67712	67714	67718	67722
	<b>euro/m</b>	<b>6,99</b>	<b>7,11</b>	<b>7,22</b>	<b>7,71</b>	<b>8,85</b>

individually packed

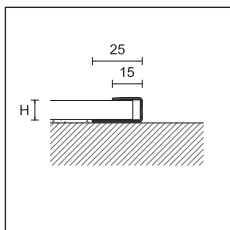

732/SF/

**PROLEVEL HIGH**

length = 270 cm - pack 15 pcs

ART.	finishing	10	12,5	15
<b>STAINLESS STEEL</b>				
<b>732/SF/</b>	polished stainless steel AISI 430 DIN 1.4016	74217	74227	74237
	<b>euro/m</b>	<b>11,19</b>	<b>12,20</b>	<b>12,20</b>

individually packed

Complete the article code with H measure (for example RC/ /F for H = 9 becomes RC/9/F)

Customized PDS decors on request, see page 195

For a single piece, see sales conditions on page 288

# alfix 616

Alfix 616 is a professional system for the laying of wooden and laminate floors with thickness from 6 to 16 mm. The system is composed of a top profile in anodised aluminium fixed with screws on a natural aluminium base. The screws, included in the packaging, have the same colour of the top profile in order to perfectly match it.



FIX/L/55 silver anodised aluminium

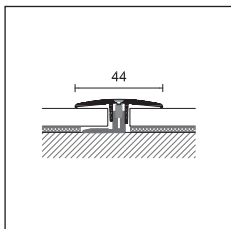

FIX/J/44

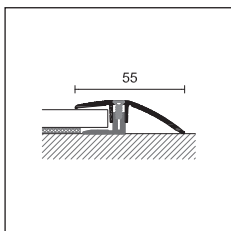

FIX/L/55

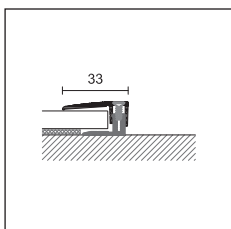

FIX/T/33

### ALFIX 616





pack	10 pcs	10 pcs / blister 	
length cm	270	90	100

ART. **FIX/J/44**

for floor thicknesses from 6 to 16 mm

#### finishing

#### ALUMINIUM

silver anodised		37010	37012	37014
sand gold anodised		37210	37212	-
<b>euro/m</b>		<b>15,27</b>	-	-
<b>euro/pc</b>		-	<b>14,71</b>	<b>16,26</b>
titanium anodised		37410	-	37414
elox bronze anodised		37310	37312	37314
<b>euro/m</b>		<b>15,98</b>	-	-
<b>euro/pc</b>		-	<b>15,37</b>	<b>16,95</b>

individually packed

### ALFIX 616





pack	10 pcs	10 pcs / blister 	
length cm	270	90	100

ART. **FIX/L/55**

for floor thicknesses from 6 to 16 mm

#### finishing

#### ALUMINIUM

silver anodised		37040	37042	37044
sand gold anodised		37240	37242	37244
<b>euro/m</b>		<b>16,64</b>	-	-
<b>euro/pc</b>		-	<b>15,93</b>	<b>17,63</b>
titanium anodised		37440	37442	37444
elox bronze anodised		37340	-	-
<b>euro/m</b>		<b>17,37</b>	-	-
<b>euro/pc</b>		-	<b>16,49</b>	<b>18,33</b>

individually packed

### ALFIX 616





pack	10 pcs	10 pcs / blister 	
length cm	270	90	100

ART. **FIX/T/33**

for floor thicknesses from 6 to 16 mm

#### finishing

#### ALUMINIUM

silver anodised		37070	-	37074
sand gold anodised		37270	37272	-
<b>euro/m</b>		<b>15,27</b>	-	-
<b>euro/pc</b>		-	<b>14,71</b>	<b>16,26</b>
titanium anodised		37470	-	37474
elox bronze anodised		-	-	37374
<b>euro/m</b>		<b>15,98</b>	-	-
<b>euro/pc</b>		-	<b>15,37</b>	<b>16,95</b>

individually packed

For a single piece, see sales conditions on page 288

 packaging in blister no partial packaging

Alfix 46 is a professional system for the laying of LVT floors from 4 to 6 mm. This system is characterized by top profiles in anodised aluminium, fixed with a screw system on a natural aluminium base. Screws, included in the package, have the same colour of the anodisation and, once fixed, integrate with the top profile.



FIX/J/30 silver anodised aluminium



FIX/L/32 silver anodised aluminium



FIX/T/19 silver anodised aluminium

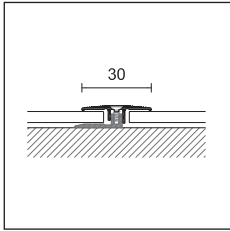

FIX/J/30

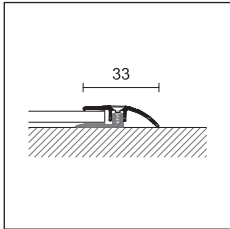

FIX/L/32

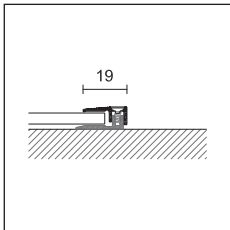

FIX/T/19

**ALFIX 46**

pack	10 pcs
length cm	270

**ART.** **FIX/J/30**

for floor thicknesses from 4 to 6 mm

**finishing**

**ALUMINIUM**

silver anodised		35500
<b>euro/m</b>		<b>15,33</b>

individually packed

**ALFIX 46**

pack	10 pcs
length cm	270

**ART.** **FIX/L/32**

for floor thicknesses from 4 to 6 mm

**finishing**

**ALUMINIUM**

silver anodised		35510
<b>euro/m</b>		<b>15,33</b>

individually packed

**ALFIX 46**

pack	10 pcs
length cm	270

**ART.** **FIX/T/19**

for floor thicknesses from 4 to 6 mm

**finishing**

**ALUMINIUM**

silver anodised		35520
<b>euro/m</b>		<b>15,33</b>

individually packed

# cerfix® projoint - pronivel

NZA/ is an expansion joint in aluminium composed of two interlocking and sliding profiles.

Suitable for LVT floors and tiles of small gaps, it guarantees a good resistance to loads and intense foot traffic. This item can be 3 mm high and, therefore, suitable for the application on substrate joints in glued LVT; it can also be 5 mm high and, in this case, thanks to the exclusive solution with the adhesive integrated with the internal anchor flange, it can be fixed directly to the board and it is the perfect joint for LVT floating floors with a uninterrupted surface and perfectly flat.



NZA/5A silver anodised aluminium

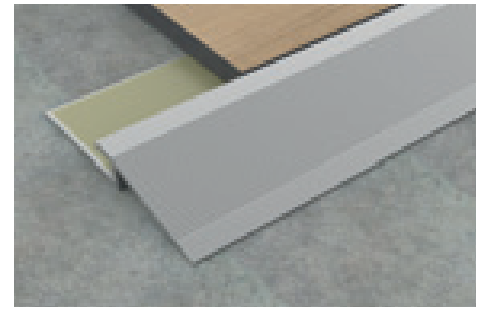

PBA/5A silver anodised aluminium

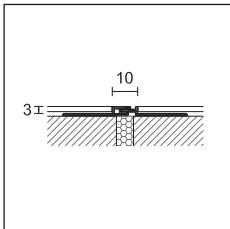

NZA/3

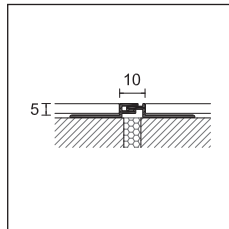

NZA/5

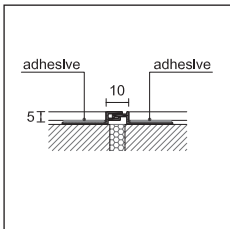

NZA/5A

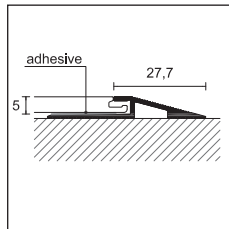

PBA/5/A

### PROJOINT

length = 270 cm - pack 20 pcs		H		
ART.	finishing	3	5	5A
<b>ALUMINIUM</b>				
	silver anodised	99300	99320	99310
	sand gold anodised	-	-	99312
<b>NZA/</b>	<b>euro/m</b>	<b>15,33</b>	<b>15,72</b>	<b>17,75</b>
	titanium anodised	-	-	99314
	elox bronze anodised	-	-	99316
	<b>euro/m</b>	-	-	<b>18,55</b>

individually packed

### PRONIVEL

length = 270 cm - pack 10 pcs		H	
ART.	finishing	5	
<b>ALUMINIUM</b>			
<b>PBA/5/A</b>	silver anodised		93205
	<b>euro/m</b>		<b>8,87</b>

individually packed

NTA/ and NTI/ are expansion joints that are also ideal for glued LVT floors and that should be installed in line with the substrate joints.



NTA/3 natural aluminium + EPDM grey

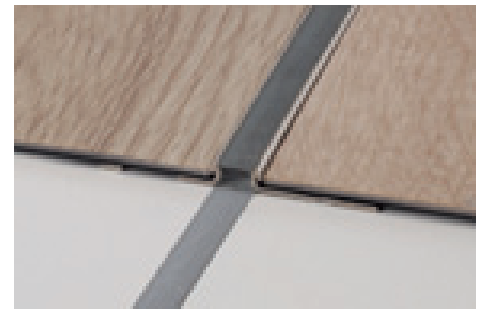

NTI/3 stainless steel + EPDM grey

### PROJOINT DIL

length = 270 cm - pack 10 pcs		H	
ART.	finishing	3	
<b>ALUMINIUM</b>			
	natural aluminium + EPDM grey polishable RAL 7046		99421
	natural aluminium + EPDM black polishable RAL 9005		99422
<b>NTA/</b>	natural aluminium + EPDM bahama polishable RAL 10070		99427
	natural aluminium + EPDM brown polishable RAL 10071		99429
	<b>euro/m</b>		<b>21,35</b>

### PROJOINT DIL

length = 270 cm - pack 10 pcs		H	
ART.	finishing	3	
<b>STAINLESS STEEL</b>			
	stainless steel AISI 304 DIN 1.4301 + EPDM grey RAL 7046		99471
	stainless steel AISI 304 DIN 1.4301 + EPDM black RAL 9005		99472
<b>NTI/</b>	stainless steel AISI 304 DIN 1.4301 + EPDM bahama RAL 10070		99431
	stainless steel AISI 304 DIN 1.4301 + EPDM brown RAL 10071		99433
	<b>euro/m</b>		<b>32,84</b>

cerfix® projoint - pronivel

H/5/F, PBAS/5/F, RC/5/F and 99/TR/26 are connection profiles in anodised aluminium, for floating LVT floors and suitable as profiles for same height, different height and for borders.

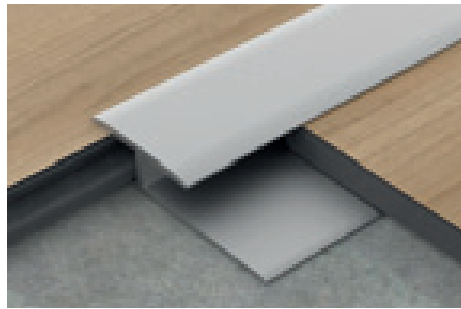

H/5/F silver anodised aluminium



PBAS/5/S silver anodised aluminium

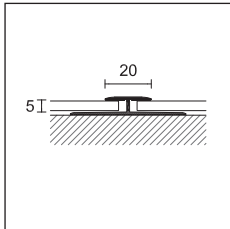

H/5/F

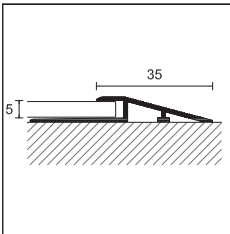

PBAS/5/F

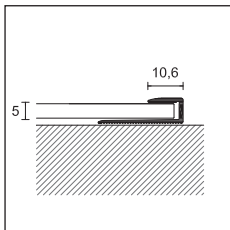

RC/5/F

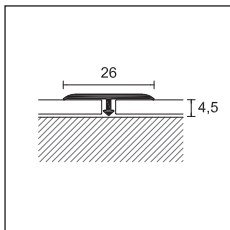

99/TR/26

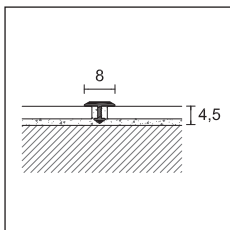

99/T/8

**PROJOINT T**

length = 270 cm - pack 20 pcs		<b>H</b>
<b>ART.</b>	<b>finishing</b>	<b>5</b>
<b>ALUMINIUM</b>		
H/5/F drilled	silver anodised	75000
	euro/m	7,13

individually packed

**PRONIVEL PB**

length = 270 cm - pack 20 pcs		<b>H</b>
<b>ART.</b>	<b>finishing</b>	<b>5</b>
<b>ALUMINIUM</b>		
PBAS/5/F drilled	silver anodised	95203
	euro/m	7,13

individually packed

**RC**

length = 270 cm - pack 20 pcs		<b>H</b>
<b>ART.</b>	<b>finishing</b>	<b>5</b>
<b>ALUMINIUM</b>		
RC/5/F drilled	silver anodised	67475
	euro/m	4,84

individually packed

**PROJOINT T**

length = 270 cm - pack 20 pcs		<b>LxH</b>
<b>ART.</b>	<b>finishing</b>	<b>26 x 4,5</b>
<b>ALUMINIUM</b>		
99/TR/26	silver anodised	75081
	euro/m	4,57

individually packed

**PROJOINT T - SEPARATION JOINTS**

length = 270 cm - pack		<b>50 pcs</b>
<b>width</b>		<b>8</b>
<b>ART.</b>	<b>finishing</b>	
<b>ALUMINIUM</b>		
	silver anodised	75075
99/T/	gold anodised	-
	euro/m	3,18
length = 270 cm - pack		<b>50 pcs</b>
<b>BRASS</b>		
399/T/	polished	75070
	euro/m	6,50
pack		<b>30 pcs</b>
399/TC/	chromium plated	75071
	euro/m	13,16

individually packed

# prostep - protect

SMA/, 75/F, 111/ /F and G/705/F are profiles in anodised aluminium suitable for stairs covered with glued LVT. ZGF/ is a profile in aluminium suitable for following the curvilinear course of stairs or floors in glued LVT.



SMA/4 silver anodised aluminium

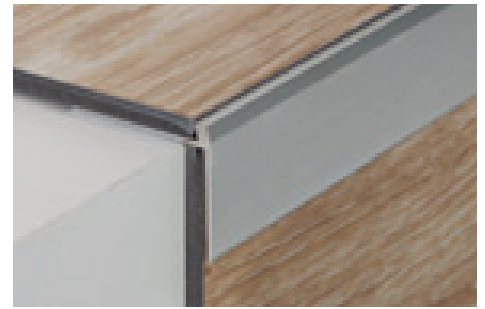

75/F silver anodised aluminium

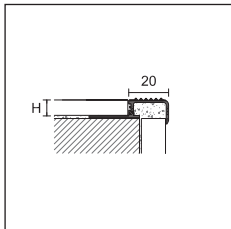

SMA/4

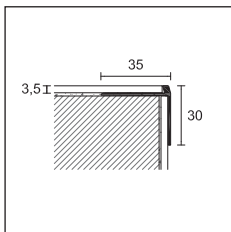

75/F

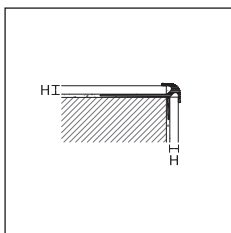

111/

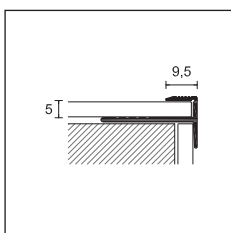

G/705/F

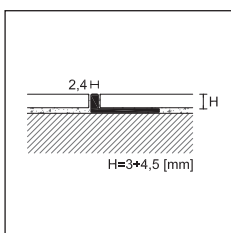

ZGF/

### PROSTEP

length = 270 cm - pack 10 pcs

H

ART. finishing

4,5

#### ALUMINIUM

SMA/	natural aluminium		93967
	euro/m		6,26
SMA/	silver anodised		93975
	euro/m		7,52

individually packed

### PROTECT

length = 340 cm - pack 20 pcs

H

ART. finishing

3,5

#### ALUMINIUM

75/F	drilled silver anodised		75388
	euro/m		6,45

### PROTECT

length = 270 cm - pack 20 pcs

H

ART. finishing

2,5

4,5

5

#### ALUMINIUM

111/ /F	silver anodised		75782	75784	75785
	euro/m		6,77	7,13	7,38

### PROSTEP

length = 270 cm - pack 10 pcs

H

ART. finishing

5

#### ALUMINIUM

G/705/F	silver anodised		67580
	euro/m		7,39

individually packed

### PRO FLEX LINE

### PROANGLE FLEX

length = 270 cm - pack 10 pcs

H

ART. finishing

4,5

#### ALUMINIUM

ZGF/	natural aluminium		88721
	euro/m		3,13



111/2,5/F silver anodised aluminium



G/705/F silver anodised aluminium

For a single piece, see sales conditions on page 288

cerfix® protrim - proangle

RA/ and RI/ are profiles that are ideal for LVT coverings and are recommended as border profiles for floors or stairs finishing.

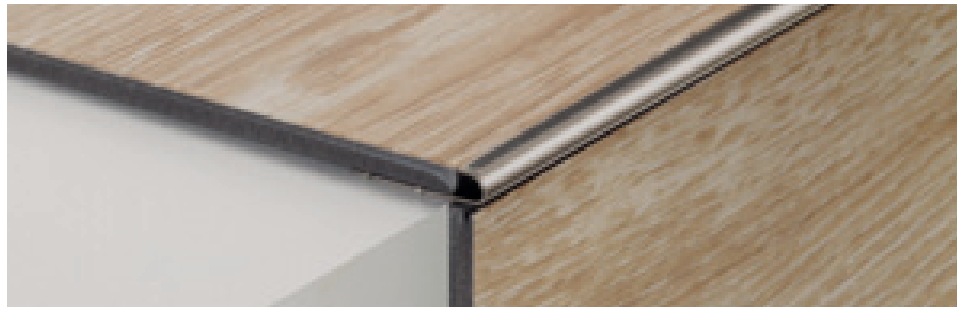

RI/4 stainless steel AISI 304 - DIN 1.4301

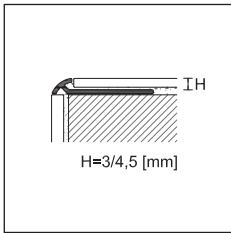

RA/

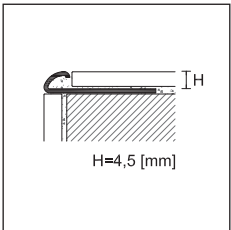

RI/

ZA/, AI/, ZQAN/, ZQKN/ and ZK/ are profiles suitable for LVT coverings and are recommended as connection and border profiles.

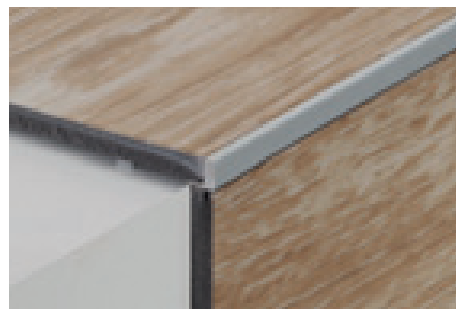

ZA/4 silver anodised aluminium

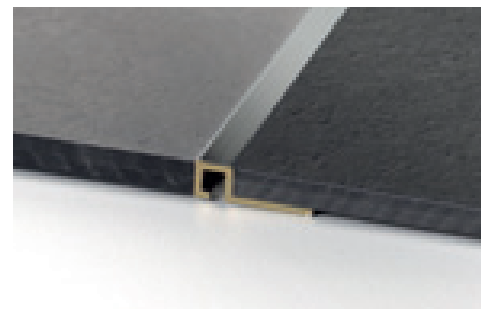

ZQKN/4 chromium-plated brass

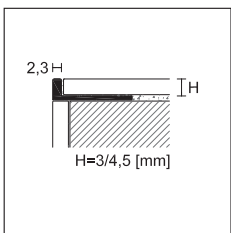

ZA/

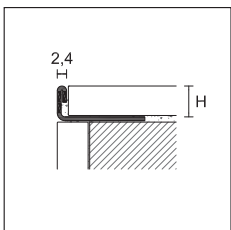

AI/

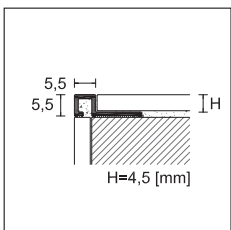

ZQAN/  
ZQKN/

**PROTRIM**

length = 270 cm - pack 20 pcs

ART.	finishing		H	
			3	4,5
<b>ALUMINIUM</b>				
	silver anodised		92055	92056
	gold anodised		92025	92026
RA/	euro/m		3,77	3,98
	titanium anodised		92085	92086
	euro/m		4,40	4,61

individually packed

**PROTRIM**

length = 270 cm - pack 20 pcs

ART.	finishing		H	
			4,5	
<b>STAINLESS STEEL</b>				
RI/	stainless steel AISI 304 DIN 1.4301			92413
	euro/m			8,27

individually packed

**PROANGLE**

length = 270 cm - pack 20 pcs

ART.	finishing		2,5	3	4,5
<b>ALUMINIUM</b>					
ZA/	silver anodised		90337	90338	90340
	euro/m		2,95	2,95	3,08
<b>STAINLESS STEEL</b>					
AI/	stainless steel AISI 304 DIN 1.4301		-	91636	91638
	euro/m		-	6,98	7,11

individually packed - version chromium - plated brass article ZK/3 and ZK/4,5 see page 29

**PROANGLE Q**

length = 270 cm - pack 20 pcs

ART.	finishing		H	
			4,5	
<b>ALUMINIUM</b>				
	silver anodised			88772
ZQAN/	euro/m			4,53
	titanium anodised			88902
	euro/m			5,16
<b>BRASS</b>				
ZQKN/	chromium plated			88870
	euro/m			16,33

individually packed

cerfix® proround

GA/, JGA/ and PIA/ are connection profiles for stairs in glued LVT. Easy to lay, they facilitate the hygienic maintenance of the connection between tread and riser.



GA/4 silver anodised aluminium



JGA/4 silver anodised aluminium

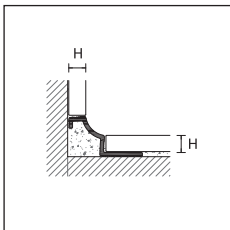

GA/

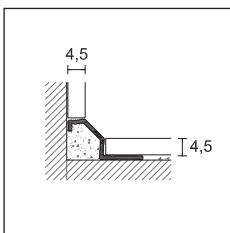

JGA/

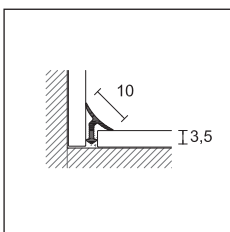

PIA/

**PROROUND M**

length = 270 cm - pack 20 pcs

<b>ART.</b>	<b>finishing</b>		<b>4,5</b>
<b>ALUMINIUM</b>			
<b>GA/</b>	silver anodised		95730
	<i>euro/m</i>		<b>7,36</b>
individually packed			

**PROROUND M**

length = 270 cm - pack 20 pcs

<b>ART.</b>	<b>finishing</b>		<b>H</b>
<b>ALUMINIUM</b>			
<b>JGA/</b>	silver anodised		95732
	<i>euro/m</i>		<b>7,36</b>
individually packed			

**PROINT**

length = 270 cm - pack 20 pcs

<b>ART.</b>	<b>finishing</b>		<b>3,5</b>
<b>ALUMINIUM</b>			
<b>PIA/</b>	silver anodised		95431
	<i>euro/m</i>		<b>4,99</b>
individually packed			



PIA/3 silver anodised aluminium

For a single piece, see sales conditions on page 288



### PVC Line skirting boards for wooden, laminate and LVT floors



PVC Line 8605 covered with Alcrom® Plus film, see page 216



PVC Line 8608 covered with Alcrom® Plus film, see page 217



PVC Line 8615 covered with Alcrom® Plus film, see page 218



PVC Line 8613 covered with Alcrom® Plus film, see page 219



PVC Line 8612 covered with Alcrom® Plus film, see page 220



PVC Line 8614 covered with Alcrom® Plus film, see page 220

## Profilpas Digital System no limits to imagination



Profilpas gives the possibility to choose between over 400 standard decors Alcrom® Plus to combine the chosen profile or skirting board with the floor perfectly: indeed, a wide selection of wood, stone or concrete decors is available in our database to meet every need.

Just consult our PDS bunch to discover the decor that best suits to your wish of combination.

But that's not all. The possibility of customization is really limitless with Profilpas. We just need to

receive a sample for creating any further decor, even a fantasy one!

This is possible thanks to Profilpas Digital System (PDS), the innovative digital printing technology of Profilpas to reproduce any decor on Alcrom Plus film and not to give limits to imagination! The whole production process is made inside our factory: from the scanner to the printing and the application of the film.

Please note: for customizations with decors that are not in our database, there is an extra of 165 € for decor.

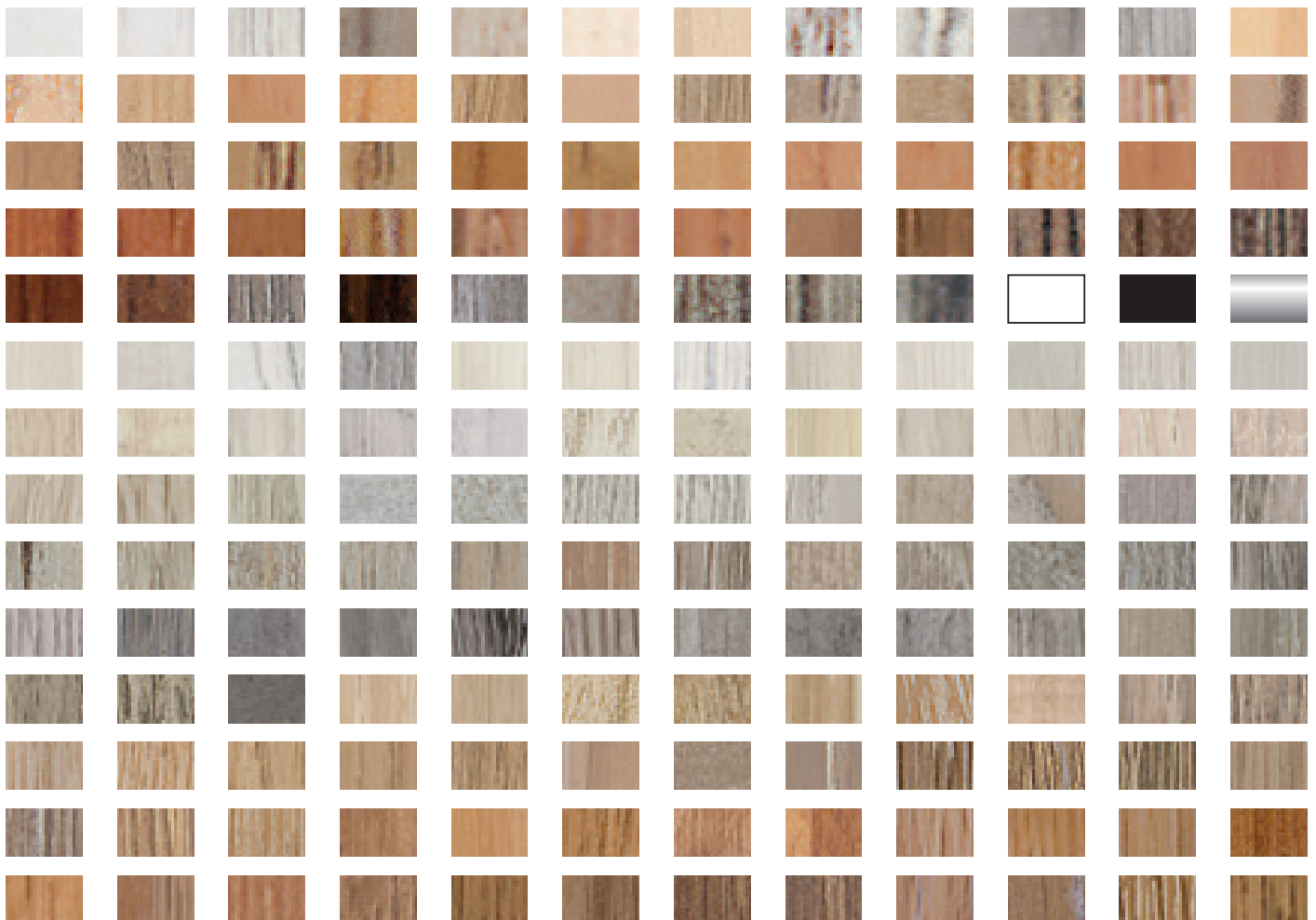



**UNISYSTEM PLUS Z/1, C/7, S/9  
PROFIX THIN Z/4, C/4 AND S/4**

Quantity 20 pcs / 54 m = + 4,93 €/m

Quantity 40 pcs / 108 m = + 4,44 €/m

Quantity 60 pcs / 162 m = + 3,96 €/m

Quantity 80 pcs / 216 m = + 3,45 €/m

Quantity 100 pcs / 270 m = + 2,95 €/m

min. 54 m

Quantity 120 pcs / 324 m = + 2,45 €/m

Quantity 140 pcs / 378 m = + 1,98 €/m

Quantity 160 pcs / 432 m = + 1,47 €/m

Quantity 180 pcs / 486 m = + 0,98 €/m

Quantity 200 pcs / 540 m = + 0,00 €/m

**Z3/30, C/10, C/13, C/22 E S/15**

min. 540 m divisible into 5 decors

**UNISYSTEM PLUS G/2 AND G/4**

min. 540 m divisible into 5 decors

**22/A, 50/A AND 63/A**

min. 540 m divisible into 5 decors

**74/A**

min. 540 m divisible into 5 decors

**RC/ /F**

min. 540 m divisible into 5 decors

**PVC LINE 8605, 8606, 8608, 8615, 8616, 8612, 8613 AND 8614** min. 540 m divisible into 2 decors

For the customization of other articles, please contact our Sales Department.  
Please note: for customizations with decors that are not in our database, there is an extra of 165 € for decor.



WOOD,  
LAMINATE, LVT





## metal line skirting board

To choose Metal Line means giving importance to details because they are the ones who make the difference. Metal Line is distinguished by its versatility and functionality, but also for its inspiration to contemporary design. It is an innovative line, rich of solutions with a wide variety of combinations and colours capable of satisfying every housing need, from small and large gathering places. Stainless steel and aluminium, materials that give shape, colour and size to the space, minimalist signs that follow the flow of everyday life. Metal Line can provide a continuum of profiles that integrate perfectly into environments and different styles, enhancing their aesthetic and architectural appeal. Metal Line becomes a trend line, thanks to Profilpas research on materials and shapes and to the attention of the company to the world of furniture and design.

# skirting board metal line

Metal Line 90 is an aluminium skirting board, available in different finishes, that creates an elegant junction between the wall and the floor. Thanks to the curved section, this skirting board perfectly hides the perimetral expansion gap of a floating floor. Metal Line 90 is also available in white and black Trend Color Stone, two matt colours that perfectly match the most modern ceramic coverings. All the models can be curved through the specific Proflex Machine.

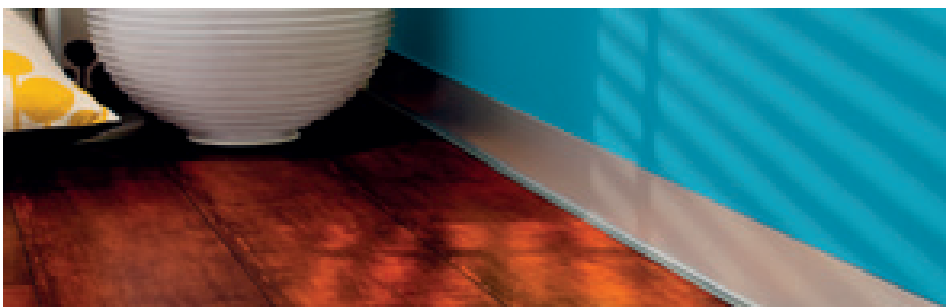

90/10 silver anodised aluminium

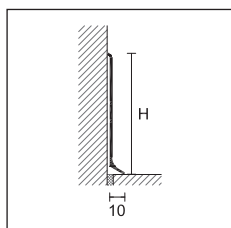

Metal Line 90 colour-coated aluminium white stone

TREND  
COLOR

## METAL LINE 90

length = 200 cm- pack 25 pcs

ART.	finishing	H cm					
		4	5	6	7	8	10
<b>ALUMINIUM</b>							
	silver anodised	78080	78084	78100	78138	78130	78137
	colour-coated polished white RAL 9010	-	-	78112	-	-	-
	colour-coated matt white RAL 9010	-	-	78110	-	-	-
	<b>euro/m</b>	<b>6,08</b>	<b>6,80</b>	<b>7,40</b>	<b>8,41</b>	<b>9,41</b>	<b>12,14</b>
<b>90/ SF</b>	titanium anodised	-	-	78103	-	-	-
	<b>euro/m</b>	-	-	<b>10,19</b>	-	-	-
	colour-coated anthracite grey	-	-	78118	-	-	-
	colour-coated ancient grey	-	-	78119	-	-	-
	<b>euro/m</b>	-	-	<b>10,78</b>	-	-	-
<b>90/ A</b>	self-adhesive silver anodised	-	-	78106	-	78136	-
	<b>euro/m</b>	-	-	<b>9,31</b>	-	<b>11,37</b>	-
<b>90/ TSF</b>	bright polished titanium	-	78087	78111	-	78141	-
<b>90/ SSF</b>	bright satin silver	78082	-	78105	-	78133	-
	bright satin gold	-	-	78107	-	78135	-
	<b>euro/m</b>	<b>9,65</b>	<b>10,68</b>	<b>11,14</b>	-	<b>14,24</b>	-
<b>90/ TMSF</b>	bright satin titanium	78088	-	78102	-	78134	-
	<b>euro/m</b>	<b>11,20</b>	-	<b>13,71</b>	-	<b>17,89</b>	-
<b>TREND COLOR STONE</b>							
<b>90/ SF</b>	colour-coated white stone	-	-	78094	-	-	-
	colour-coated black stone	-	-	78099	-	-	-
	<b>euro/m</b>	-	-	<b>10,78</b>	-	-	-
<b>ANTIBACTERIAL COLOUR-COATED ALUMINIUM</b>							
<b>NEW 90H/ SF</b>	colour-coated white RAL 9003 antibacterial	-	-	78104	-	-	-
	<b>euro/m</b>	-	-	<b>13,72</b>	-	-	-

individually packed

90/4SF, 90/5SF, 90/6SF and 90/8SF in silver anodised aluminium, available also in length 400 cm

## PROFLEX LINE

Metal Line 90 can be curved by using Proflex Machine + wheels kit for Metal Line 90 (vedi pag 267)

The self-adhesive version in height 4, 5, 7, and 10 is available on request, with a minimum order of 200 meters and a surcharge of 2,04 €/mt

RAL 9003, RAL 7038, RAL 8019, RAL 9006, RAL 9007 colour-coated aluminium skirting boards are available on request, with a minimum order of 300 meters. For other colours, please contact our sales department.

Complete the article code with H measure (for example 90/SF for H=4 becomes 90/4SF)

For a single piece, see sales conditions on page 288



inside corner, outside corner, junction and right-left end caps

**INSIDE CORNER**

pack 4 pcs		H cm						
ART.	finishing	4	5	6	7	8	10	
<b>METAL</b>								
90/ MI	silver		78630	78640	78650	78660	78670	78680
	<i>euro/pc</i>		5,41	5,41	5,41	5,41	5,41	5,41
	titanium		-	-	78654	-	-	-
	polished white RAL 9010		-	-	78664	-	-	-
	matt white RAL 9010		-	-	78674	-	-	-
	anthracite grey		-	-	78684	-	-	-
	ancient grey		-	-	78694	-	-	-
	polished titanium		-	78644	78704	-	78708	-
	satin silver		78718	-	78720	-	78722	-
	satin gold		-	-	78724	-	78744	-
satin titanium		78714	-	78734	-	78754	-	
<i>euro/pc</i>		5,90	5,90	5,90	-	5,90	-	
90/ MI	white stone		-	-	78172	-	-	-
	black stone		-	-	78173	-	-	-
<i>euro/pc</i>		-	-	6,55	-	-	-	
90H/ MI	white RAL 9003 antibacterial		-	-	78690	-	-	-
	<i>euro/pc</i>		-	-	6,99	-	-	-

**POLYPROPYLENE**

90/ I	silver anodised		78236	78231	78190	78370	78195	78091
	<i>euro/pc</i>		2,72	2,72	2,72	2,72	2,72	2,72

no partial packaging

**JUNCTION**

pack 4 pcs		H cm						
ART.	finishing	4	5	6	7	8	10	
<b>METAL</b>								
90/ MG	silver		78632	78642	78652	78662	78672	78682
	<i>euro/pc</i>		5,41	5,41	5,41	5,41	5,41	5,41
	titanium		-	-	78656	-	-	-
	polished white RAL 9010		-	-	78666	-	-	-
	matt white RAL 9010		-	-	78676	-	-	-
	anthracite grey		-	-	78686	-	-	-
	ancient grey		-	-	78696	-	-	-
	polished titanium		-	78646	78706	-	78710	-
	satin silver		78738	-	78740	-	78742	-
	satin gold		-	-	78726	-	78746	-
satin titanium		78716	-	78736	-	78756	-	
<i>euro/pc</i>		5,90	5,90	5,90	-	5,90	-	
90/ MG	white stone		-	-	78187	-	-	-
	black stone		-	-	78188	-	-	-
<i>euro/pc</i>		-	-	6,55	-	-	-	
90H/ MG	white RAL 9003 antibacterial		-	-	78692	-	-	-
	<i>euro/pc</i>		-	-	6,99	-	-	-

**POLYPROPYLENE**

90/ G	silver anodised		78237	78232	78192	78372	78197	78092
	<i>euro/pc</i>		2,72	2,72	2,72	2,72	2,72	2,72

no partial packaging

**OUTSIDE CORNER**

pack 4 pcs		H cm						
ART.	finishing	4	5	6	7	8	10	
<b>METAL</b>								
90/ ME	silver		78631	78641	78651	78661	78671	78681
	<i>euro/pc</i>		5,41	5,41	5,41	5,41	5,41	5,41
	titanium		-	-	78655	-	-	-
	polished white RAL 9010		-	-	78665	-	-	-
	matt white RAL 9010		-	-	78675	-	-	-
	anthracite grey		-	-	78685	-	-	-
	ancient grey		-	-	78695	-	-	-
	polished titanium		-	78645	78705	-	78709	-
	satin silver		78728	-	78730	-	78732	-
	satin gold		-	-	78725	-	78745	-
satin titanium		78715	-	78735	-	78755	-	
<i>euro/pc</i>		5,90	5,90	5,90	-	5,90	-	
90/ ME	white stone		-	-	78174	-	-	-
	black stone		-	-	78178	-	-	-
<i>euro/pc</i>		-	-	6,55	-	-	-	
90H/ ME	white RAL 9003 antibacterial		-	-	78691	-	-	-
	<i>euro/pc</i>		-	-	6,99	-	-	-

**POLYPROPYLENE**

90/ E	silver anodised		78235	78230	78191	78371	78196	78090
	<i>euro/pc</i>		2,72	2,72	2,72	2,72	2,72	2,72

no partial packaging

**RIGHT/LEFT END CAPS**

4 couples pack		H cm						
ART.	finishing	4	5	6	7	8	10	
<b>METAL</b>								
90/ MP	silver		78633	78643	78653	78663	78673	78683
	<i>euro/couple</i>		5,65	5,65	5,65	5,65	5,65	5,65
	titanium		-	-	78657	-	-	-
	polished white RAL 9010		-	-	78667	-	-	-
	matt white RAL 9010		-	-	78677	-	-	-
	anthracite grey		-	-	78687	-	-	-
	ancient grey		-	-	78697	-	-	-
	polished titanium		-	78647	78707	-	78711	-
	satin silver		78748	-	78750	-	78752	-
	satin gold		-	-	78727	-	78747	-
satin titanium		78717	-	78737	-	78757	-	
<i>euro/couple</i>		6,16	6,16	6,16	-	6,16	-	
90/ MP	white stone		-	-	78189	-	-	-
	black stone		-	-	78199	-	-	-
<i>euro/couple</i>		-	-	6,79	-	-	-	
90H/ MP	white RAL 9003 antibacterial		-	-	78693	-	-	-
	<i>euro/couple</i>		-	-	7,25	-	-	-

**POLYPROPYLENE**

90/ P	silver anodised		78238	78233	78193	78373	78198	78093
	<i>euro/couple</i>		2,72	2,72	2,72	2,72	2,72	2,72

no partial packaging

On request, corners in pack of 1 pc in blister + 1,47 € (in this case 90/6/MI code 78654 becomes 78654/B) - Complete the article code with the height H (for example 90/ MI with H=4 becomes 90/4MI)

For a single piece, see sales conditions on page 288

# skirting board metal line

Metal Line 790 is a skirting board in polished or satin stainless steel, available in different heights, that follows the minimalist trends of modern design. Thanks to the curved section, this skirting board perfectly hides the perimetral expansion gap of a floating floor. Metal Line 790 can be easily and quickly installed through specific adhesives.



790/6 polished stainless steel AISI 304 DIN 1.4301

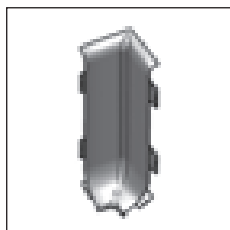
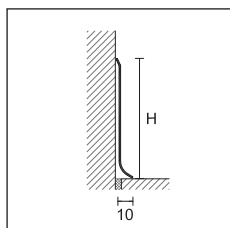

790/MI  
790/MIS

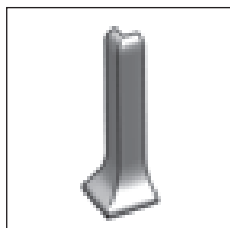

790/ME  
790/MES

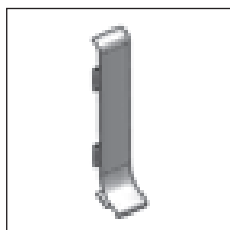

790/MG  
790/MGS

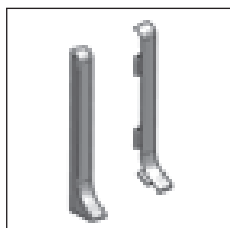

790/MP  
790/MPS

On request, corners in pack of 1 pc in blister + 1,47 € (in this case 790/6/MI code 78762 becomes 78762/B)

The self-adhesive version is available in every height on request, with a minimum order of 200 meters and a surcharge of 2,04 €/m

Complete the article code with H measure (for example 790/SF for H=4 becomes 790/4SF)

For a single piece, see sales conditions on page 288

## METAL LINE 790

length = 270 cm - pack 10 pcs

		H cm					
ART.	finishing	4	5	6	8	10	
<b>STAINLESS STEEL</b>							
790/ SF	polished stainless steel AISI 304 DIN 14301		78120	78108	78129	78132	78139
	<i>euro/m</i>		<b>7,07</b>	<b>8,75</b>	<b>10,49</b>	<b>13,70</b>	<b>17,02</b>
	satin stainless steel AISI 304 DIN 1.4301		78128	78109	78126	78127	78140
	<i>euro/m</i>		<b>9,49</b>	<b>11,21</b>	<b>13,47</b>	<b>17,89</b>	<b>21,87</b>

individually packed - art. 790/10 SF pack 5 pcs

## INSIDE CORNER IN METAL

pack 4 pcs

		H cm					
ART.	finishing	4	5	6	8	10	
790/ MI	finishing polished		78760	78761	78762	78763	78764
	<i>euro/pc</i>		<b>8,44</b>	<b>8,44</b>	<b>8,44</b>	<b>8,44</b>	<b>8,44</b>
790/ MIS	finishing satin		78780	78781	78782	78783	78784
	<i>euro/pc</i>		<b>11,97</b>	<b>11,97</b>	<b>11,97</b>	<b>11,97</b>	<b>11,97</b>

no partial packaging

## OUTSIDE CORNER IN METAL

pack 4 pcs

		H cm					
ART.	finishing	4	5	6	8	10	
790/ ME	finishing polished		78765	78766	78767	78768	78769
	<i>euro/pc</i>		<b>8,44</b>	<b>8,44</b>	<b>8,44</b>	<b>8,44</b>	<b>8,44</b>
790/ MES	finishing satin		78785	78786	78787	78788	78789
	<i>euro/pc</i>		<b>10,96</b>	<b>10,96</b>	<b>10,96</b>	<b>10,96</b>	<b>10,96</b>

no partial packaging

## JUNCTION IN METAL

pack 4 pcs

		H cm					
ART.	finishing	4	5	6	8	10	
790/ MG	finishing polished		78770	78771	78772	78773	78774
	<i>euro/pc</i>		<b>8,44</b>	<b>8,44</b>	<b>8,44</b>	<b>8,44</b>	<b>8,44</b>
790/ MGS	finishing satin		78790	78791	78792	78793	78794
	<i>euro/pc</i>		<b>10,96</b>	<b>10,96</b>	<b>10,96</b>	<b>10,96</b>	<b>10,96</b>

no partial packaging

## RIGHT/LEFT END CAPS IN METAL

4 couples pack

		H cm					
ART.	finishing	4	5	6	8	10	
790/ MP	finishing polished		78775	78776	78777	78778	78779
	<i>euro/couple</i>		<b>8,96</b>	<b>8,96</b>	<b>8,96</b>	<b>8,96</b>	<b>8,96</b>
790/ MPS	finishing satin		78795	78796	78797	78798	78799
	<i>euro/couple</i>		<b>11,48</b>	<b>11,48</b>	<b>11,48</b>	<b>11,48</b>	<b>11,48</b>

no partial packaging



Metal Line 92 and 93 are two skirting boards in aluminium, characterized by a simple design and a slightly-rounded shape, that create a perfect junction between the floor and the wall. These two elements are easy to install thanks to the interlocking system with supports, in natural aluminium or PVC, to be fixed to the wall with screws and dowels.



92/7 silver anodised aluminium + S/95 aluminium support

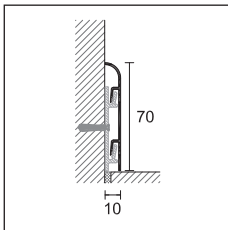

92/7

**METAL LINE 92**

length = 200 cm + 3 supports - pack 20 pcs

**H cm**

**ART. finishing**

**7**

**ALUMINIUM**

92/7 silver anodised  
euro/m



78490  
9,49

individually packed

**ALUMINIUM SUPPORT**

pack 100 pcs

S/95  
euro/pc

78295  
0,37

**METAL LINE 93**

length = 200 cm + 5 supports - pack 20 pcs

**H cm**

**ART. finishing**

**7**

**9**

**ALUMINIUM**

93/ silver anodised  
euro/m



78495  
10,65

78496  
14,35

individually packed

**FIXING CLIPS**

pack 100 pcs

8608/C  
euro/pack

29751  
11,01

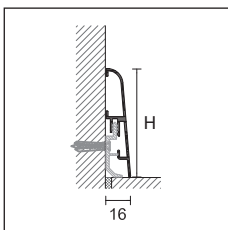

93/

Ancient grey, RAL 9003, RAL 7038, RAL 8019, RAL 9006, RAL 9007 colour-coated aluminium skirting boards are available on request, with a minimum order of 300 meters. For other colours, please contact our sales department.

For a single piece, see sales conditions on page 288



93/7 silver anodised aluminium + 8608/C fixing clips

# skirting board

## metal line

Metal Line 89 is a skirting board in aluminium, in different finishes, characterized by square and minimalist lines; available in different heights, it outlines the space with simplicity and elegance. Fixed on the wall through specific adhesives, it perfectly hides the perimetral expansion gap of a floating floor, as well as having a decorative role. Metal Line 89 is also available in white and black Trend Color Stone, two matt colours that perfectly combines with the most modern ceramic coverings.

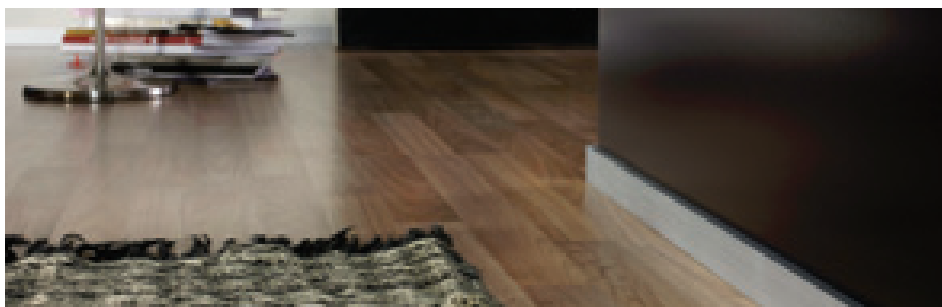

89/4 silver anodised aluminium

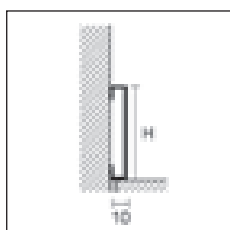

89/  
89/ TM  
89H/

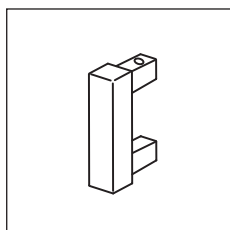

89/ EI  
89/ TMEI  
89H/ EI

TREND  
COLOR

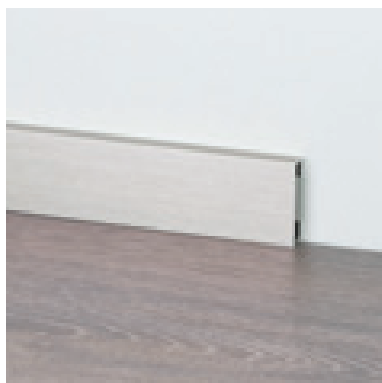

Metal Line 89 bright satin titanium



89/4 ancient grey colour-coated aluminium + 89/4EI

Complete the article code with H measure (for example 89/ for H=4 becomes 89/4).

For a single piece, see sales conditions on page 288

### METAL LINE 89

length = 200 cm - pack 25 pcs

ART. finishing 4 6 8 H cm

ALUMINIUM

	silver anodised		78378	78478	78487
	<i>euro/m</i>		<b>7,93</b>	<b>8,64</b>	<b>9,24</b>
	titanium anodised		78521	78522	-
	<i>euro/m</i>		<b>10,56</b>	<b>11,24</b>	-
89/	colour-coated matt white RAL 9010		78517	78518	-
	<i>euro/m</i>		<b>7,93</b>	<b>8,64</b>	-
	colour-coated ancient grey		78515	78485	-
	colour-coated rust		78516	-	-
	<i>euro/m</i>		<b>11,29</b>	<b>11,69</b>	-
89/ TM	bright satin titanium		78388	78480	-
	<i>euro/m</i>		<b>13,77</b>	<b>14,56</b>	-

### TREND COLOR STONE

89/	colour-coated white stone		78481	-	-
	colour-coated black stone		78482	-	-
	<i>euro/m</i>		<b>11,29</b>	-	-

### COLOUR-COATED ALUMINIUM ANTIBACTERIAL

<b>NEW 89H/</b>	colour-coated white RAL 9003 antibacterial		-	78531	-
	<i>euro/m</i>		-	<b>14,48</b>	-

individually packed

Ancient grey, RAL 9003, RAL 7038, RAL 8019, RAL 9006, RAL 9007 colour-coated aluminium skirting boards are available on request, with a minimum order of 300 meters. For other colours, please contact our sales department.

### INSIDE/OUTSIDE CORNER - RIGHT/LEFT END CAP

pack 4 pcs

ART. finishing 4 6 8 H cm

ALUMINIUM

	silver anodised		78505	78506	78527
	<i>euro/pc</i>		<b>9,00</b>	<b>9,00</b>	<b>9,49</b>
	titanium anodised		78523	78524	-
	<i>euro/pc</i>		<b>9,00</b>	<b>9,00</b>	-
89/ EI	colour-coated matt white RAL 9010		78519	78520	-
	<i>euro/pc</i>		<b>9,00</b>	<b>9,00</b>	-
	colour-coated ancient grey		78512	78513	-
	colour-coated rust		78514	-	-
	<i>euro/pc</i>		<b>9,00</b>	<b>9,00</b>	-
89/ TMEI	bright satin titanium		78509	78510	-
	<i>euro/pc</i>		<b>9,00</b>	<b>9,00</b>	-
89/ EI	colour-coated white stone		78507	-	-
	colour-coated black stone		78508	-	-
	<i>euro/pc</i>		<b>9,00</b>	-	-
89H/ EI	colour-coated white RAL 9003 antibacterial		-	78533	-
	<i>euro/pc</i>		-	<b>11,69</b>	-

no partial packaging

In anodised aluminium, Metal Line 89 I Design is characterized by a special scratched finish and original colours that allow different chromatic combinations, created for interior designers and architects by following the latest trends of modern design.

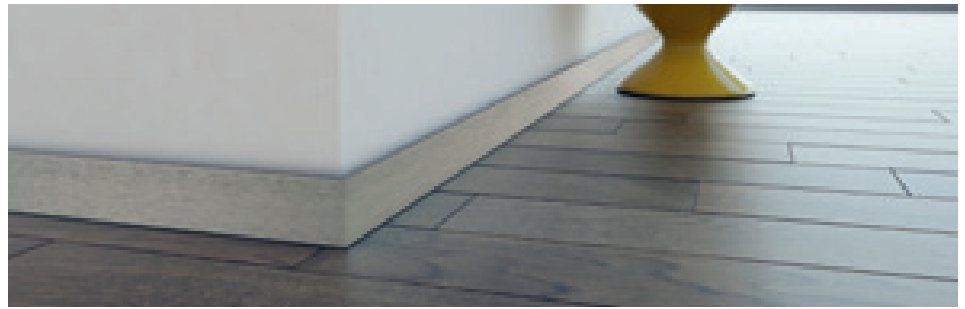

89/6 titanium anodised aluminium

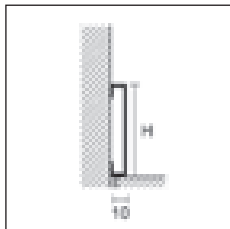

89/



89/ EI

Complete the article code with H measure (for example 89/ for H=4 becomes 89/4)

For a single piece, see sales conditions on page 288

Metal Line 89 is a skirting board in anodised aluminium with LED-strip lighting system. The light is distributed along the entire length of the profile through a diffuser element. It is possible to insert the dimmer in order to adjust the luminous intensity of the skirting board to decorate and light up the room.

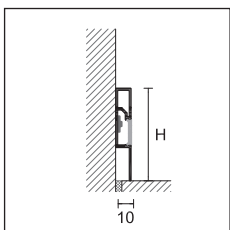

89/6L

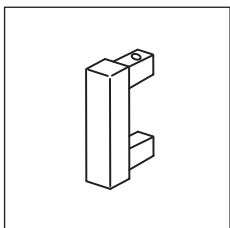

89/6EI

For the best aesthetic result and the validity of the warranty, we suggest the exclusive use of our electrical components. See page 240

For a single piece, see sales conditions on page 288

**METAL LINE - I DESIGN**

length = 200 cm - pack 25 pcs

		H	
ART.	finishing	4	6
<b>ANODISED ALUMINIUM</b>			
	platinum	31400	31402
	titanium	31410	31412
89/	brown	31420	31422
	dark brown	31430	31432
	carbon	31440	31442
	<b>euro/m</b>	<b>16,47</b>	<b>19,38</b>

individually packed

**OUTSIDE / INSIDE CORNERS / END CAPS**

pack 2 pcs

		H	
ART.	finishing	4	6
<b>ANODISED ALUMINIUM</b>			
	platinum	31450	31452
	titanium	31460	31462
89/ EI	brown	31470	31472
	dark brown	31480	31482
	carbon	31490	31492
	<b>euro/pc</b>	<b>20,76</b>	<b>20,76</b>

no partial packaging

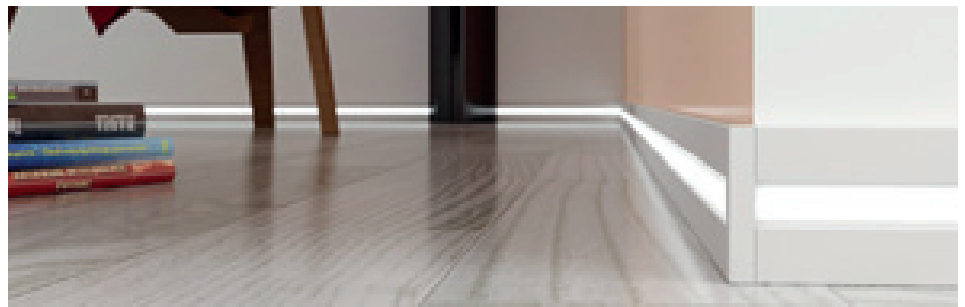

89/6L silver anodised aluminium

**PROLIGHT METAL LINE 89**

length = 200 cm - pack 25 pcs

		H cm	
ART.	finishing	6	
<b>ALUMINIUM</b>			
89/6L	silver anodised	86000	
	<b>euro/m</b>	<b>14,66</b>	

individually packed

**INSIDE/OUTSIDE CORNER - RIGHT/LEFT END CAP**

pack 4 pcs

		H cm	
ART.	finishing	6	
<b>ALUMINIUM</b>			
89/6EI	silver anodised	78506	
	<b>euro/pc</b>	<b>10,28</b>	

no partial packaging

# skirting board

## metal line

Metal Line 89/613 is a skirting board in aluminium characterized by square and minimalist lines. With a thickness of 13 mm, it perfectly hides the perimetral expansion gap of a floating floor.



89/613 silver anodised aluminium

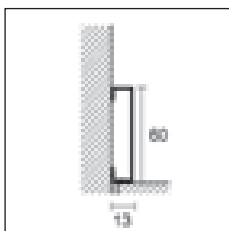

89/613

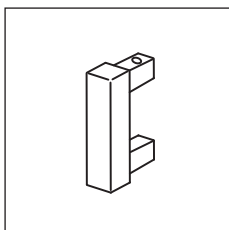

89/613 EI

### METAL LINE 89/613



length = 200 cm - pack 25 pcs

H cm

ART. finishing

6

#### ALUMINIUM

	silver anodised		78486
	<i>euro/m</i>		<b>9,24</b>
<b>89/613</b>	colour-coated matt white RAL 9010		78488
	<i>euro/m</i>		<b>10,78</b>

individually packed

### INSIDE/OUTSIDE CORNER - RIGHT/LEFT END CAP



pack 4 pcs

H cm

ART. finishing

6

#### ALUMINIUM

	silver anodised		78525
	<i>euro/pc</i>		<b>9,49</b>
<b>89/613 EI</b>	colour-coated matt white RAL 9010		78526
	<i>euro/pc</i>		<b>9,49</b>

no partial packaging

Metal Line 105 is a skirting board in aluminium, characterized by square and minimalist lines. This model stands out for a simple and quick interlocking installation system with a coextruded PVC base to be fixed to the wall through screws and dowels.



Metal Line 105 silver anodised aluminium

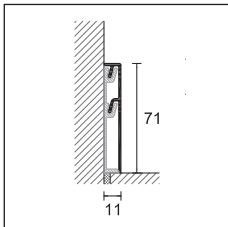

105/7  
105/CB



105/71



105/7E



105/7G

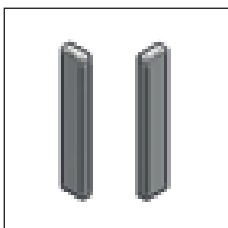

105/7P

**NEW METAL LINE**

pack 10 pcs				H cm
ART.	finishing	length	7	
<b>ALUMINIUM</b>				
105/7	silver anodised		200 cm	78900
	silver anodised		400 cm	78910
	<i>euro/m</i>			<b>17,70</b>

individually packed

**FIXING BASE**

pack 10 pcs				H cm
ART.	finishing	length	7	
<b>CO-EXTRUDED PVC</b>				
105/CB	white		200 cm	78920
	<i>euro/m</i>			<b>2,50</b>

no partial packaging

**INSIDE CORNER**

pack 4 pcs				H cm
ART.	finishing	length	7	
<b>METAL</b>				
105/7I	silver			78932
	<i>euro/pc</i>			<b>6,86</b>

no partial packaging

**OUTSIDE CORNER**

pack 4 pcs				H cm
ART.	finishing	length	7	
<b>METAL</b>				
105/7E	silver			78934
	<i>euro/pc</i>			<b>6,86</b>

no partial packaging

**JUNCTION**

pack 4 pcs				H cm
ART.	finishing	length	7	
<b>METAL</b>				
105/7G	silver			78936
	<i>euro/pc</i>			<b>6,86</b>

no partial packaging

**RIGHT/LEFT END CAP**

4 couples pack				H cm
ART.	finishing	length	7	
<b>METAL</b>				
105/7P	silver			78938
	<i>euro/couple</i>			<b>6,86</b>

no partial packaging

## metal line

Metal Line 87/6 and 88/6 are two flush recessed skirting boards for plaster and plasterboards. Both are composed of two separate elements: a base in natural aluminium and an insert in silver anodised or matt white colour-coated aluminium. Once installed, the skirting board integrates perfectly into the wall surface, outlining the perimeter of the space without limiting it. There are two different phases of installation: the base element must be installed when the room is still in its rough state, while the chosen insert must be put after the laying of the floor.



87/6 e 88/6 natural aluminium + 88/16L/A aluminium insert for LED light

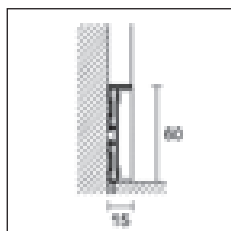

87/6 + 88/16SF  
aluminium insert

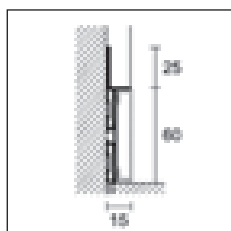

88/6 + 88/16SF  
aluminium insert

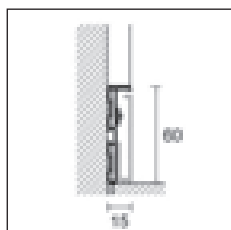

87/6 + 88/16L/A  
aluminium insert for  
LED light

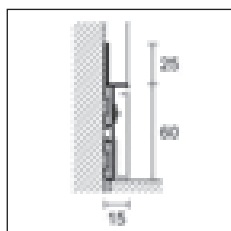

88/6 + 88/16L/A  
aluminium insert for  
LED light

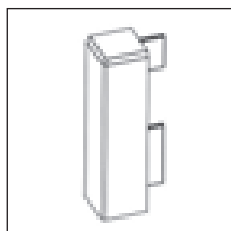

88/6E

For the best aesthetic result and the validity of the warranty, we suggest the exclusive use of our electrical components. See page 240

For a single piece, see sales conditions on page 288

### METAL LINE 87 E 88

length = 200 cm - pack 20 pcs		H cm
<b>ART.</b>	<b>finishing</b>	<b>6</b>
<b>ALUMINIUM</b>		
<b>87/6</b>	natural aluminium (drilled) <i>euro/m</i>	78338 <b>11,41</b>
<b>88/6</b>	natural aluminium (drilled) <i>euro/m</i>	78310 <b>13,59</b>

individually packed

### ALUMINIUM INSERT

length = 200 cm - pack 20 pcs		H cm
<b>ART.</b>	<b>finishing</b>	<b>6</b>
<b>88/16SF</b>	silver anodised matt white RAL 9010 colour-coated <i>euro/m</i>	78563 78558 <b>8,80</b>

individually packed

### ALUMINIUM INSERT FOR LED LIGHT

length = 200 cm - pack 20 pcs		H cm
<b>88/16L/A</b>	silver anodised matt white RAL 9010 colour-coated <i>euro/m</i>	78559 78560 <b>10,83</b>

adhesive - individually packed  
foa electrical components, see page 59

### METAL OUTSIDE CORNER

pack 4 pcs		H cm
<b>ART.</b>	<b>finishing</b>	<b>6</b>
<b>88/6E</b>	silver matt white RAL 9010 colour-coated <i>euro/pc</i>	78561 78562 <b>10,12</b>

no partial packaging



88/6 natural aluminium + 88/16SF matt white aluminium insert

Prolight Metal Line SKL/2 is a skirting board in aluminium with indirect LED light. Its special section allows to create an original play of light along the wall, thus adding value to the whole surface. In addition to the silver anodised and the white stone versions, SKL/2 is available in a wide range of colours including five original cement effects, two special metal tonalities and a white characterized by an extremely solid and full colour.



SKL/2 concrete white colour-coated aluminium

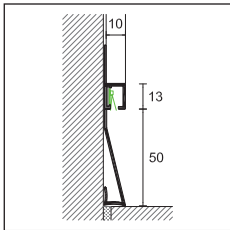

SKL/2

**PROLIGHT METAL LINE S**

length = 270 cm - pack 5 pcs

**H**

**ART. finishing**

**10**

**ALUMINIUM**

SKL/2 silver anodised  
euro/m

78579

14,74

**COLOUR-COATED ALUMINIUM**

SKL/2 white stone  
concrete white  
concrete graphite  
concrete smoke  
concrete mud  
concrete sand  
metal dark  
metal light  
solid white  
euro/m

78591

78592

78593

78594

78595

78596

78597

78598

78599

25,28

individually packed

**ELECTRICAL COMPONENTS AND ACCESSORIES FOR LIGHTING**

**ART.**

**description**

L5/NW/65 L

spool 5 m LED strips, lateral light, neutral colour 4000 °K, 9,6W/m IP65

84136

euro/mt (euro/pack)

33,13 (165,63)

For other electrical components see page 240

Metal Line AF M Design is a skirting board in aluminium characterized by modern and minimalist lines that mark the connection between floors and coverings of same or different materials. The empty space creates an elegant shadow that highlights the two surfaces distinctly.



AF/1 silver anodised aluminium

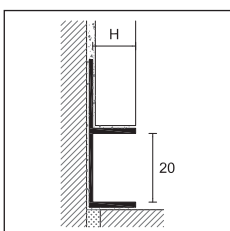

AF/1

**METAL LINE AF - M DESIGN**

length = 270 cm - pack 10 pcs

**H**

**ART. finishing**

**6**

**10**

**12,5**

**ALUMINIUM**

silver anodised  
euro/m

13198

13199

13200

8,34

8,34

8,34

AF/1 titanium anodised  
colour-coated polished white RAL 9010  
euro/m

13201

13203

13202

13196

13197

13204

12,16

12,16

12,16

individually packed

For a single piece, see sales conditions on page 288

# skirting board

## metal line

Metal Line 100 is an anodized aluminium baseboard available in two heights and suitable for application of plasterboard, directly into the wall. The profile is easy to apply through the use of appropriate adhesives.



100/70 silver anodised aluminium

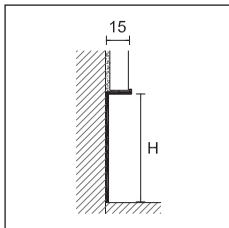

100/

### METAL LINE 100

length = 200 cm - pack 20 pcs

H mm

ART.	finishing	40	70
------	-----------	----	----

### ALUMINIUM

100/	silver anodised	78277	78279
	<i>euro/m</i>	<b>7,93</b>	<b>11,19</b>

individually packed

Metal Line 101, ideal for plaster and made of anodized aluminium, is suitable for application directly on the rough wall. The profile is applied using special adhesives, before making the plastering of the wall.



101/74 silver anodised aluminium

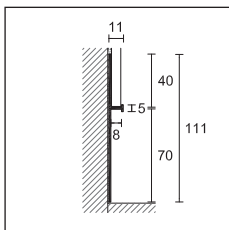

101/74

### METAL LINE 101

length = 200 cm - pack 20 pcs

H mm

ART.	finishing	70
------	-----------	----

### ALUMINIUM

101/74	silver anodised	78281
	<i>euro/m</i>	<b>15,17</b>

individually packed

### MS POLYMER-BASED ADHESIVE FOR SKIRTING BOARDS

pack 24 pcs - quantity 290 ml

### ART.

PP/96	78301
-------	-------

<i>euro/pc</i>	<b>18,81</b>
----------------	--------------

output 10/15 m for cartridge

Ancient grey, RAL 9003, RAL 7038, RAL 8019, RAL 9006, RAL 9007 colour-coated aluminium skirting boards are available on request, with a minimum order of 300 meters.

For other colours, please contact our sales department.

For a single piece, see sales conditions on page 288



Metal Line 95 is a skirting board in aluminium, available in two different heights, that allows to hide service cables (telephone, computers, TV etc.). This model is characterized by a simple and quick interlocking installation system with natural aluminium supports that, fixed to the wall with screws and dowels, facilitate the removal for the maintenance of the service cables.



95/7 silver anodised aluminium

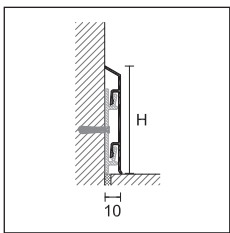

95/

**METAL LINE 95**

pack 25 pcs		length	H cm	
ART.	finishing		7	10
<b>ALUMINIUM</b>				
95/ SF	silver anodised	200 cm + 3 supports	78160	78175
		400 cm + 6 supports	78161	78176
		<i>euro/m</i>	<b>9,31</b>	<b>13,06</b>

individually packed - length 400 cm pack 10 pcs

**ALUMINIUM SUPPORT**

pack 100 pcs			H cm	
ART.	finishing		7	10
S/95			78295	
		<i>euro/pc</i>	<b>0,37</b>	

no partial packaging

**INSIDE CORNER IN POLYPROPYLENE**

pack 4 pcs			H cm	
ART.	finishing		7	10
95/ I	silver anodised		78201	78206
		<i>euro/pc</i>	<b>3,31</b>	<b>3,31</b>

no partial packaging

**OUTSIDE CORNER IN POLYPROPYLENE**

pack 4 pcs			H cm	
ART.	finishing		7	10
95/ E	silver anodised		78200	78205
		<i>euro/pc</i>	<b>3,31</b>	<b>3,31</b>

no partial packaging

**JUNCTION IN POLYPROPYLENE**

pack 4 pcs			H cm	
ART.	finishing		7	10
95/ G	silver anodised		78202	78207
		<i>euro/pc</i>	<b>3,31</b>	<b>3,31</b>

no partial packaging

**RIGHT/LEFT END CAPS IN POLYPROPYLENE**

4 couples pack			H cm	
ART.	finishing		7	10
95/ P	silver anodised		78203	78208
		<i>euro/couple</i>	<b>3,31</b>	<b>3,31</b>

no partial packaging



95/7 silver anodised aluminium + S/95 aluminium support

Ancient grey, RAL 9003, RAL 7038, RAL 8019, RAL 9006, RAL 9007 colour-coated aluminium skirting boards are available on request, with a minimum order of 300 meters. For other colours, please contact our sales department.

Complete the article code with H measure (for example 95/SF for H=7 becomes 95/7SF)

For a single piece, see sales conditions on page 288

## metal line

Metal Line 98 is a skirting board in aluminium characterized by round and soft lines and a thickness that allows the housing of service cables (telephone, computer, TV, etc.). A simple and functional interlocking installation system with natural aluminium supports to be fixed to the wall provides easy access to the cables for their maintenance.

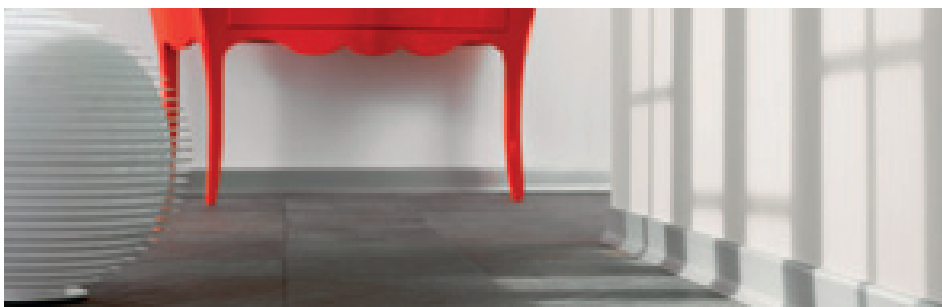

98/7SF silver anodised aluminium

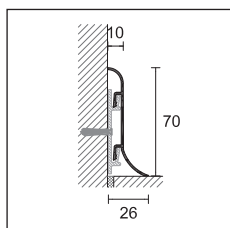

98/7SF



98/7SF silver anodised aluminium + S/95 aluminium support

### METAL LINE 98

pack 20 pcs

H cm

ART. finishing length 7

#### ALUMINIUM

98/7SF	silver anodised	200 cm + 3 supports	78040
		400 cm + 6 supports	78041
<i>euro/m</i>			<b>12,54</b>

individually packed - length 400 cm pack 10 pcs

### ALUMINIUM SUPPORT

pack 100 pcs

S/95	78295
<i>euro/pc</i>	<b>0,37</b>

no partial packaging

### INSIDE CORNER IN POLYPROPYLENE

pack 4 pcs

H cm

ART. finishing	7
98/7I silver anodised	78221
<i>euro/pc</i>	<b>3,31</b>

no partial packaging

### OUTSIDE CORNER IN POLYPROPYLENE

pack 4 pcs

H cm

ART. finishing	7
98/7E silver anodised	78220
<i>euro/pc</i>	<b>3,31</b>

no partial packaging

### JUNCTION IN POLYPROPYLENE

pack 4 pcs

H cm

ART. finishing	7
98/7G silver anodised	78222
<i>euro/pc</i>	<b>3,31</b>

no partial packaging

### RIGHT/LEFT END CAPS IN POLYPROPYLENE

4 couples pack

H cm

ART. finishing	7
98/7P silver anodised	78223
<i>euro/couple</i>	<b>3,31</b>

no partial packaging

Ancient grey, RAL 9003, RAL 7038, RAL 8019, RAL 9006, RAL 9007 colour-coated aluminium skirting boards are available on request, with a minimum order of 300 meters. For other colours, please contact our sales department.

For a single piece, see sales conditions on page 288

Metal Line 97/4 is a 4 cm high aluminium skirting board that allows the housing of service cables (telephone, computer, TV, etc.). Thanks to a simple interlocking installation system with harmonic stainless steel clips to be fixed to the wall with screws and dowels, it combines ease and speed of installation with easy access to the cables for their maintenance.

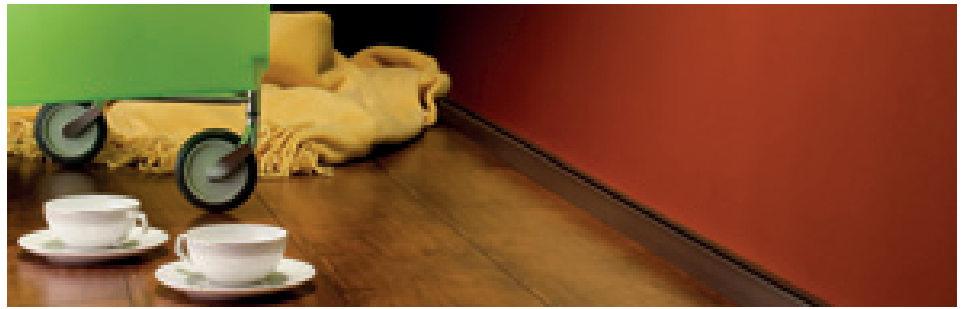

97/4TMSF silver anodised aluminium

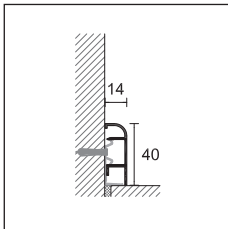

97/



97/4SF silver anodised aluminium  
+ 8602/C fixing clip

#### METAL LINE 97

length = 200 cm - pack 25 pcs

H cm

ART.	finishing		4
<b>ALUMINIUM</b>			
97/4SF + 5 clips	silver anodised		78000
	euro/m		7,95

individually packed

#### FIXING CLIPS

10 blister packs / 20 pcs/blister

8602/C		29750
euro/blister		5,93

no partial packaging

#### INSIDE CORNER IN POLYPROPYLENE

pack 4 pcs

H cm

ART.	finishing		4
97/4I	silver anodised		78002
	euro/pc		4,31

no partial packaging

#### OUTSIDE CORNER IN POLYPROPYLENE

pack 4 pcs

H cm

ART.	finishing		4
97/4E	silver anodised		78001
	euro/pc		4,31

no partial packaging

#### JUNCTION IN POLYPROPYLENE

pack 4 pcs

H cm

ART.	finishing		4
97/4G	silver anodised		78003
	euro/pc		4,31

no partial packaging

#### RIGHT/LEFT END CAPS IN POLYPROPYLENE

4 couples pack

H cm

ART.	finishing		4
97/4P	silver anodised		78004
	euro/couple		4,31

no partial packaging

Ancient grey, RAL 9003, RAL 7038, RAL 8019, RAL 9006, RAL 9007 colour-coated aluminium skirting boards are available on request, with a minimum order of 300 meters. For other colours, please contact our sales department.

For a single piece, see sales conditions on page 288

# skirting board

## metal line

Metal Line 97/7 is a 7 cm high aluminium skirting board with a simple and linear design. Easy and quick to install thanks to an interlocking installation system with natural aluminium supports to be fixed to the wall with screws and dowels, it provides easy access to the cables for their maintenance.

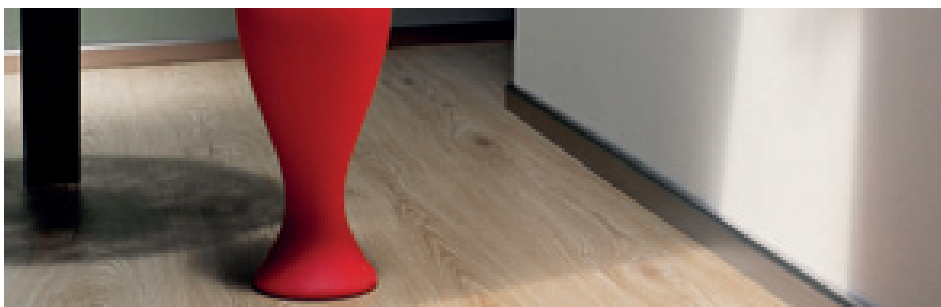

97/7SF silver anodised aluminium

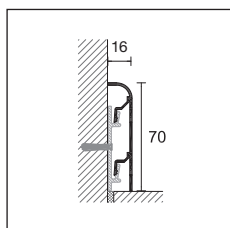

97/7SF

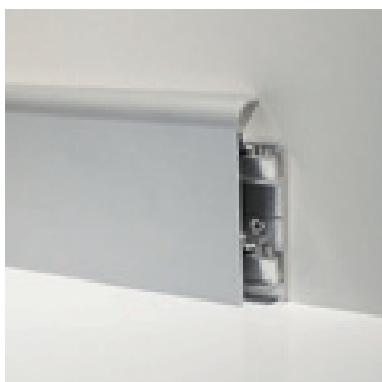

97/7SF silver anodised aluminium + S/95 aluminium support

### METAL LINE 97

length = 200 cm - pack 20 pcs

H cm

ART. finishing

7

### ALUMINIUM

97/7SF +  
3 supports  
silver anodised  
euro/m

78005

13,43

individually packed

### ALUMINIUM SUPPORT

pack 100 pcs

S/95

78295

euro/pc

0,37

no partial packaging

### INSIDE CORNER IN POLYPROPYLENE

pack 4 pcs

H cm

ART. finishing

7

97/7I silver anodised  
euro/pc

78157

3,31

no partial packaging

### OUTSIDE CORNER IN POLYPROPYLENE

pack 4 pcs

H cm

ART. finishing

7

97/7E silver anodised  
euro/pc

78156

3,31

no partial packaging

### JUNCTION IN POLYPROPYLENE

pack 4 pcs

H cm

ART. finishing

7

97/7G silver anodised  
euro/pc

78158

3,31

no partial packaging

### RIGHT/LEFT END CAPS IN POLYPROPYLENE

4 couples pack

H cm

ART. finishing

7

97/7P silver anodised  
euro/couple

78159

3,31

no partial packaging

Ancient grey, RAL 9003, RAL 7038, RAL 8019, RAL 9006, RAL 9007 colour-coated aluminium skirting boards are available on request, with a minimum order of 300 meters.

For other colours, please contact our sales department.

For a single piece, see sales conditions on page 288

Metal Line 97/8 is a 8 cm high aluminium skirting board specially designed for housing cables thanks to the specific PVC cable trunking that, fixed to the wall with screws and dowels, also acts as support of the skirting board. It is particularly suitable for renovations as it avoids making new tracks for the passage of cables. It is also easy and quick to install only using natural aluminium supports that, fixed to the wall with screws and dowels, make the access to service cables easy.

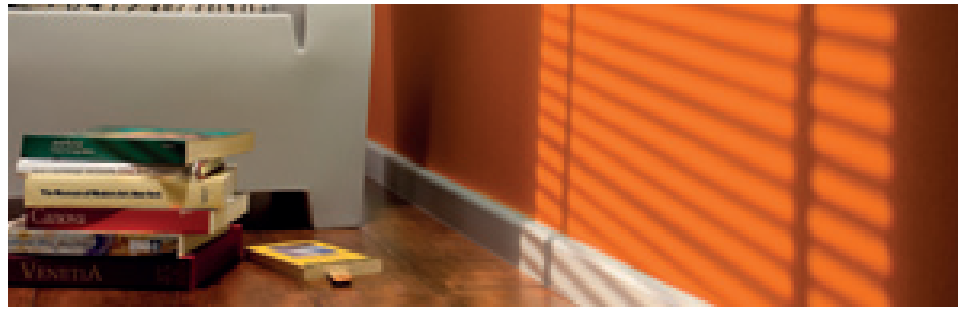

97/8SF silver anodised aluminium

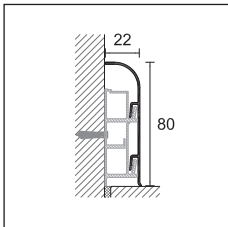

97/8SF



97/8SF silver anodised aluminium  
+ 97/8CB white pvc trunking

#### METAL LINE 97

pack 20 pcs			H cm
ART.	finishing	length	8
<b>ALUMINIUM</b>			
97/8SF	silver anodised	200 cm + 3 supports	78010
		400 cm + 6 supports	78011
	<i>euro/m</i>		<b>13,99</b>

individually packed - length 400 cm pack 10 pcs

#### WHITE PVC TRUNKING

length 200 cm - pack 20 pcs		
97/8CB	<input type="checkbox"/>	78290
<i>euro/m</i>		<b>4,96</b>

no partial packaging

#### ALUMINIUM SUPPORT

pack 100 pcs		
S/97		78299
<i>euro/pc</i>		<b>0,66</b>

no partial packaging

#### INSIDE CORNER IN POLYPROPYLENE

pack 4 pcs			H cm
ART.	finishing		8
97/8I	silver anodised		78211
	<i>euro/pc</i>		<b>3,31</b>

no partial packaging

#### OUTSIDE CORNER IN POLYPROPYLENE

pack 4 pcs			H cm
ART.	finishing		8
97/8E	silver anodised		78210
	<i>euro/pc</i>		<b>3,31</b>

no partial packaging

#### JUNCTION IN POLYPROPYLENE

pack 4 pcs			H cm
ART.	finishing		8
97/8G	silver anodised		78212
	<i>euro/pc</i>		<b>3,31</b>

no partial packaging

#### RIGHT/LEFT END CAPS IN POLYPROPYLENE

4 couples pack			H cm
ART.	finishing		8
97/8P	silver anodised		78213
	<i>euro/couple</i>		<b>3,31</b>

no partial packaging

Ancient grey, RAL 9003, RAL 7038, RAL 8019, RAL 9006, RAL 9007 colour-coated aluminium skirting boards are available on request, with a minimum order of 300 meters. For other colours, please contact our sales department.

For a single piece, see sales conditions on page 288





## PVC line skirting board

A range of PVC skirting boards to meet all technical and aesthetical needs. Suitable for both professional and DIY use, some models can be customised using digital printing technology PDS.

# skirting board

## pvc line

PVC Line 8605 and 8606 are two skirting boards in co-extruded PVC, characterized by a rounded shape and a 70-mm height. Both are composed of a core in foam PVC and a visible surface in coloured rigid PVC to guarantee the best aesthetic result and colour uniformity. 8605 can also be covered with Alcrom® Plus film and can be further customized thanks to the digital printing technology Profilpas Digital System. 8605 and 8606 can be fixed to the wall with adhesive (PP/96) or nails. Moreover, they do not absorb water and are resistant to impact, wear and tear, UV rays and the products normally used for cleaning floors and wall coverings.



8606 white RAL 9003 co-extruded PVC

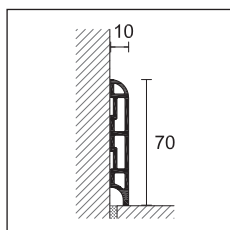

8605

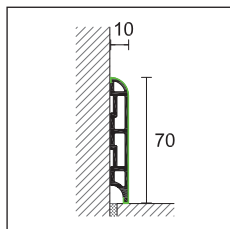

8605 covered with Alcrom® Plus film



8605 foam PVC covered with Alcrom® Plus film

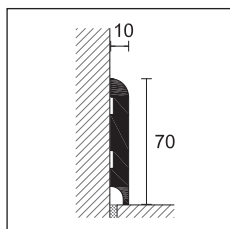

8606

MS polymer-based adhesive for skirting boards see page 266

For customizations with decors that are not in our database, there is an extra of 165 € for decor.

For a single piece, see sales conditions on page 288

### NEW PVC LINE

length 250 cm - pack 20 pcs - H = 70 mm

#### CO-EXTRUDED PVC (FOAM PVC + RIGID PVC)

##### ART.

8605	<input type="checkbox"/>	white RAL 9003	29175	<input type="checkbox"/>	black RAL 9004	29176
	<input type="checkbox"/>	white RAL 9010	29177			
<b>euro/m</b>						<b>2,94</b>
8605	<input type="checkbox"/>	silver	29178			

##### euro/m

no partial packaging

#### PVC LINE

length 250 cm - pack 20 pcs - H = 70 mm

#### CO-EXTRUDED PVC (FOAM PVC + RIGID PVC) COVERED WITH ALCROM® PLUS FILM

##### ART.

##### decors

8605	<input type="checkbox"/>	96 white RAL 9010 embossed	29030
	<input type="checkbox"/>	97 black RAL 9005 embossed	29031
<b>euro/m</b>			<b>3,72</b>
8605	<input type="checkbox"/>	99 satin silver	29035
	<input type="checkbox"/>	100 satin steel	29036

##### euro/m

**5,23**

no partial packaging

#### PVC LINE

length = 250 cm - pack 20 pcs - H = 70 mm

#### CO-EXTRUDED PVC (FOAM PVC + RIGID PVC) COVERED WITH ALCROM® PLUS FILM

##### ART.

##### decors

##### decors

##### decors

##### decors

8605	<input type="checkbox"/>	02 29000	<input type="checkbox"/>	41 29012	<input type="checkbox"/>	1006 29102	<input type="checkbox"/>	1060 29120
	<input type="checkbox"/>	08 29001	<input type="checkbox"/>	44 29013	<input type="checkbox"/>	1009 29103	<input type="checkbox"/>	1063 29121
	<input type="checkbox"/>	09 29002	<input type="checkbox"/>	47 29033	<input type="checkbox"/>	1012 29104	<input type="checkbox"/>	1066 29122
	<input type="checkbox"/>	10 29003	<input type="checkbox"/>	48 29015	<input type="checkbox"/>	1021 29107	<input type="checkbox"/>	1069 29123
	<input type="checkbox"/>	11 29004	<input type="checkbox"/>	65 29018	<input type="checkbox"/>	1024 29108	<input type="checkbox"/>	1081 29127
	<input type="checkbox"/>	12 29005	<input type="checkbox"/>	76 29020	<input type="checkbox"/>	1030 29110	<input type="checkbox"/>	1084 29128
	<input type="checkbox"/>	20 29006	<input type="checkbox"/>	77 29021	<input type="checkbox"/>	1033 29111	<input type="checkbox"/>	1087 29129
	<input type="checkbox"/>	25 29032	<input type="checkbox"/>	78 29022	<input type="checkbox"/>	1036 29112	<input type="checkbox"/>	1090 29130
	<input type="checkbox"/>	32 29007	<input type="checkbox"/>	80 29023	<input type="checkbox"/>	1042 29114	<input type="checkbox"/>	1105 29135
	<input type="checkbox"/>	34 29008	<input type="checkbox"/>	81 29024	<input type="checkbox"/>	1045 29115	<input type="checkbox"/>	1108 29136
	<input type="checkbox"/>	35 29009	<input type="checkbox"/>	92 29026	<input type="checkbox"/>	1051 29117	<input type="checkbox"/>	1111 29137
	<input type="checkbox"/>	36 29010	<input type="checkbox"/>	95 29029	<input type="checkbox"/>	1054 29118		
	<input type="checkbox"/>	40 29011	<input type="checkbox"/>	1003 29101	<input type="checkbox"/>	1057 29119		

##### euro/m

**3,72**

no partial packaging - 8605 can be covered with customised Alcrom® Plus film on request, with a minimum order of 500 meters €/m 3,72

### NEW PVC LINE

length 250 cm - pack 20 pcs - H = 70 mm

#### CO-EXTRUDED PVC (FOAM PVC + RIGID PVC)

##### ART.

8606	<input type="checkbox"/>	white RAL 9003	29227	<input type="checkbox"/>	black RAL 9004	29228
	<input type="checkbox"/>	white RAL 9010	29229			
<b>euro/m</b>						<b>4,41</b>
8606	<input type="checkbox"/>	silver	29230			

##### euro/m

no partial packaging - 8606 can be covered with customised Alcrom® Plus film on request, with a minimum order of 500 meters €/m 5,04



PVC Line 8608 is a skirting board in PVC foam, characterized by a round shape and covered with Alcrom® Plus film. Available in several decors, it can be further customized thanks to the digital printing technology Profilpas Digital System. 8608 can be fixed to the wall with adhesive (PP/96 or similar), nails or special fixing clips. PVC does not absorb water, does not contain formaldehyde, is resistant to shocks, wear (certificate AC3), UV rays and the most common cleaning products for floors and wall coverings.

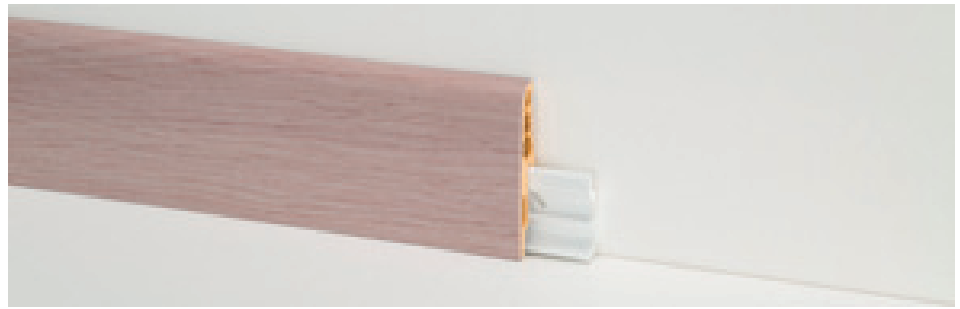

8608 foam PVC covered with Alcrom® Plus film + 8608/C

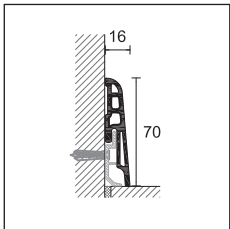

8608

**PVC LINE**

length = 250 cm - pack 20 pcs

**FOAM PVC COVERED WITH ALCROM® PLUS FILM**

H = 70 mm

ART.	decors	decors	decors
	02 29040	32 29047	77 29061
	05 29075	34 29048	78 29062
	08 29041	35 29049	80 29063
	10 29043	36 29050	81 29064
	11 29044	39 29080	89 29081
<b>8608</b>	12 29045	40 29051	91 29082
	14 29076	41 29052	92 29066
	19 29077	44 29053	95 29069
	20 29046	47 29073	96 white RAL 9010 embossed 29070
	26 29078	65 29058	97 black RAL 9005 embossed 29071
	31 29079	76 29060	
<b>euro/m</b>		<b>3,89</b>	
<b>8608</b>		99 satin silver 29083	
		100 satin steel 29084	
<b>euro/m</b>		<b>5,45</b>	

no partial packaging

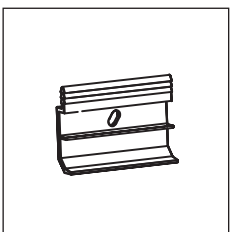

8608/C

**FIXING CLIPS FOR ART. 8608**

pack of 100 pcs

<b>8608/C</b>	29751
<b>euro/pack</b>	<b>11,01</b>



8608 foam PVC covered with Alcrom® Plus film Plus 99 satin silver

MS polymer-based adhesive for skirting boards see page 266

Customized PDS decors on request for 8608 with a minimum order of 500 meters.

For customizations with decors that are not in our database, there is an extra of 165 € for decor.

For a single piece, see sales conditions on page 288

# skirting board

## pvc line

PVC Line 8615 and 8616 are two skirting boards in co-extruded PVC, characterized by a square shape and a 70-mm height. Both are composed of a core in foam PVC and a visible surface in coloured rigid PVC to guarantee the best aesthetic result and colour uniformity.

They can also be covered with Alcrom® Plus film and can be further customized thanks to the digital printing technology Profilpas Digital System.

8615 and 8616 can be fixed to the wall with adhesive (PP/96) or nails. Moreover, they do not absorb water and are resistant to impact, wear and tear, UV rays and the products normally used for cleaning floors and wall coverings.



8615 silver co-extruded PVC

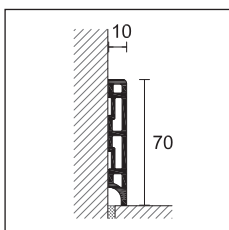

8615

### NEW PVC LINE

length 250 cm - pack 20 pcs - H = 70 mm

#### CO-EXTRUDED PVC (FOAM PVC + RIGID PVC)

##### ART.

<b>8615</b>	<input type="checkbox"/>	white RAL 9003	29353	<input checked="" type="checkbox"/>	black RAL 9004	29354
	<input type="checkbox"/>	white RAL 9010	29355			
<b>euro/m</b>						<b>2,94</b>
<b>8615</b>	<input checked="" type="checkbox"/>	silver	29356			
<b>euro/m</b>						

no partial packaging

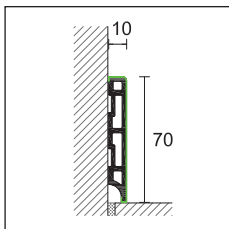

8615 decors with film Alcrom® Plus

### NEW PVC LINE

length 250 cm - pack 20 pcs - H = 70 mm

#### CO-EXTRUDED PVC (FOAM PVC + RIGID PVC) COVERED WITH ALCROM® PLUS FILM

##### ART. decors

<b>8615</b>	<input type="checkbox"/>	96 white RAL 9010 embossed	29357			
	<input checked="" type="checkbox"/>	97 black RAL 9005 embossed	29358			
<b>euro/m</b>						<b>3,72</b>

no partial packaging

8615 can be covered with customised Alcrom® Plus film on request, with a minimum order of 500 meters €/m 3,72

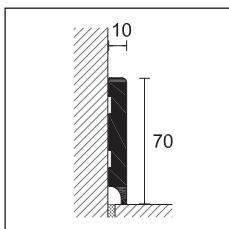

8616

### NEW PVC LINE

length 250 cm - pack 20 pcs - H = 70 mm

#### CO-EXTRUDED PVC (FOAM PVC + RIGID PVC)

##### ART.

<b>8616</b>	<input type="checkbox"/>	white RAL 9003	29495	<input checked="" type="checkbox"/>	black RAL 9004	29496
<b>euro/m</b>						<b>4,41</b>
<b>8616</b>	<input checked="" type="checkbox"/>	silver	29498			
<b>euro/m</b>						

no partial packaging

8616 can be covered with customised Alcrom® Plus film on request, with a minimum order of 500 meters €/m 5,04



8616 black RAL 9004 co-extruded PVC

MS polymer-based adhesive for skirting boards see page 266

For customizations with decors that are not in our database, there is an extra of 165 € for decor.

For a single piece, see sales conditions on page 288



8615 white RAL 9003 co-extruded PVC

PVC Line 8613 is a foam PVC skirting board covered with Alcrom® Plus film, suitable for wooden floors. It can be fixed to the wall with adhesive (PP/96) or fixing clip 8608/C.



8613 foam PVC covered with Alcrom® Plus film - decor 96

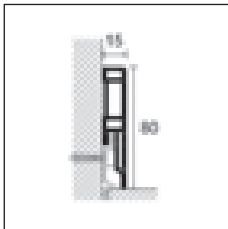

8613

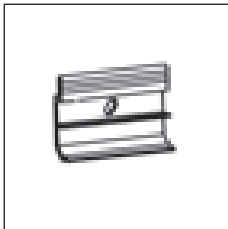

8608/C

**PVC LINE**

length = 250 cm - pack 20 pcs

**FOAM PVC COVERED WITH ALCROM® PLUS FILM**

H = 80 mm

ART.	decors		decors	
	05	30060	580	30076
	08	30061	1202	30078
	12	30062	1203	30079
	13	30063	1204	30080
	14	30064	1205	30081
	19	30065	1206	30082
	26	30066	1207	30083
	31	30094	1208	30084
<b>8613</b>	32	30067	1209	30085
	36	30068	1210	30086
	39	30069	1211	30087
	40	30070	1212	30088
	41	30071	1213	30089
	77	30072	1214	30090
	89	30073	1215	30091
	91	30074	1216	30092
	93	30075	1217	30093
	96 white RAL 9010 embossed	29971		
	<b>euro/m</b>		<b>4,80</b>	
<b>8613</b>	99 satin silver	29974		
	100 satin steel	29975		
	<b>euro/m</b>	<b>6,34</b>		

no partial packaging

**FIXING CLIPS FOR ART. 8613**

pack of 100 pcs

<b>8608/C</b>	29751
<b>euro/pack</b>	<b>11,01</b>

no partial packaging



8613 covered with Alcrom® Plus film - decor 100 satin steel

Customized PDS decors on request for 8613 with a minimum order of 500 meters.

For customizations with decors that are not in our database, there is an extra of 165 € for decor.

For a single piece, see sales conditions on page 288

# skirting board

## pvc line

PVC Line 8612 is a foam PVC skirting board covered with Alcrom® Plus film, suitable for both ceramic and LVT floors. It can be fixed to the wall with adhesive (PP/96).



8612/10 foam PVC covered with Alcrom® Plus film - decor 96

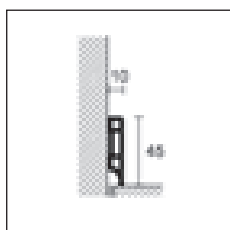

8612/10

### PVC LINE

length 250 cm - pack 20 pcs

#### FOAM PVC COVERED WITH ALCROM® PLUS FILM

H = 45 mm

ART.	decors		
	96 white RAL 9010 embossed	<input type="checkbox"/>	29970
	<i>euro/m</i>		<b>3,72</b>
<b>8612/10</b>	99 satin silver	<input checked="" type="checkbox"/>	29968
	100 satin steel	<input checked="" type="checkbox"/>	29967
	<i>euro/m</i>		<b>5,23</b>

no partial packaging

PVC Line 8614 is a foam PVC skirting board covered with white Alcrom® Plus film, suitable in case of refurbishment if you want to cover the old skirting boards that are still fixed to the wall. It can be fixed to the old skirting board with adhesive (PP/96).



8614 foam PVC covered with Alcrom® Plus film - decor 96

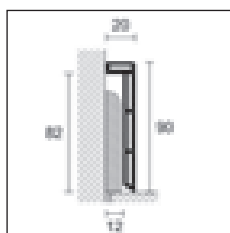

8614

### PVC LINE

length = 250 cm - pack 20 pcs

#### FOAM PVC COVERED WITH ALCROM® PLUS FILM

H = 90 mm

ART.	decors		
	96 white RAL 9010 embossed	<input type="checkbox"/>	29972
<b>8614</b>	<i>euro/m</i>		<b>5,18</b>

no partial packaging

8612 and 8614 can be covered with customised Alcrom® Plus film on request, with a minimum order of 500 meters.

For customizations with decors that are not in our database, there is an extra of 165 € for decor.

For a single piece, see sales conditions on page 288

PVC Line 8600 is a foam PVC skirting board, particularly suitable for DIY installations thanks to its quick and easy application. It is available in different colours and can be fixed with adhesive (PP/96).

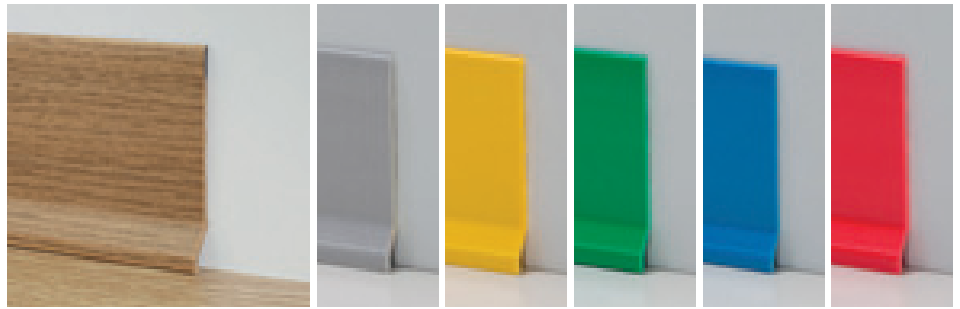

8600 foam PVC decor 532

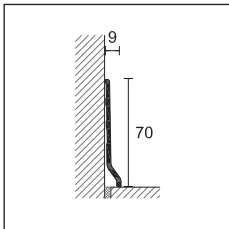

8600

**PVC LINE**

length 200 cm - pack 20/100 pcs

**FOAM PVC**

H = 70 mm

ART.	decors		decors		decors		decors	
	518	29762	536	29782	giallo 561	29802	silver 559	29800
	520	29764	540	29784	verde 562	29804		
	524	29766	542	29786	azzurro 563	29801		
	525	29768	544	29788	rosso 564	29803		
<b>8600</b>	528	29770	545	29790				
	530	29772	white 555	29792				
	531	29774	light grey 556	29794				
	532	29776	black 557	29796				
	533	29778	anthracite 558	29798				
	534	29780						
pack 20 pcs								
	<i>euro/m</i>		<b>1,42</b>		<b>1,48</b>		<b>1,68</b>	
pack 100 pcs								
	<i>euro/m</i>		<b>1,14</b>		<b>1,19</b>		<b>1,39</b>	

no partial packaging

external corner profiles available in the same decors, see page 45

PVC Line 8181 is a 70 mm high skirting board in plastic-coated PVC, characterized by a special shape that makes it suitable for installation on curved walls. 8181 is particularly suitable for DIY installation, thanks to its quick and easy application. Available in different colours, it can be fixed to the wall with adhesive (PP/96).



PVC Line 8181 white PVC

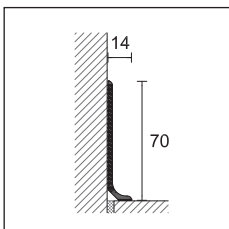

8181

**NEW PVC LINE**

length = 250 cm - pack 12 pcs

**PLASTIC-COATED PVC**

H = 70 mm

ART.	decors		
	white		19216
	grey		19217
<b>8181</b>	black		19218
	<i>euro/m</i>		<b>4,62</b>

no partial packaging

To order 8600 in pack of 100 pcs mark /100 after the article code (for example 29778 becomes 29778/100).

For a single piece, see sales conditions on page 288

# skirting board

## pvc line

PVC Line 8596 and 8598 are two impact-resistant skirting boards in foam PVC. The upper part resting on the wall and the lower part resting on the floor are in soft material and allow a perfect adhesion even to surfaces that are not perfectly planar, maintaining speed and simplicity of application. They are available in different colours and can be fixed with adhesive (PP/96).



8596 Foam PVC decor 545

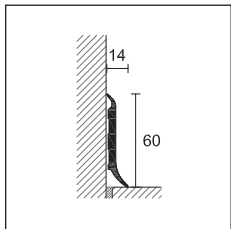

8596

### PVC LINE

length = 250 cm - pack 40 pcs

### FOAM PVC

H = 60 mm

ART.	decors		decors		decors	
	518	30800	531	30812	542	30824
	524	30804	532	30814	545	30828
<b>8596</b>	525	30806	533	30816	white 555	30830
	528	30808	536	30820	light grey 556	30832
	530	30810	540	30822	black 557	30834

euro/m

2,15

no partial packaging

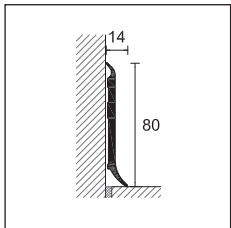

8598

### PVC LINE

length = 250 cm - pack 40 pcs

### FOAM PVC

H = 80 mm

ART.	decors	
	white 555	30880
<b>8598</b>	light grey 556	30882
	black 557	30884

euro/m

2,37

no partial packaging

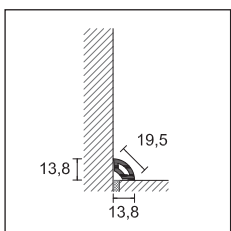

8580

### PVC LINE

length = 250 cm - pack 80 pcs

### FOAM PVC

ART.	decors		decors	
	532	30764	white 555	30780
<b>8580</b>	542	30774	light grey 556	30782
	545	30778	black 557	30784

euro/m

0,67

no partial packaging

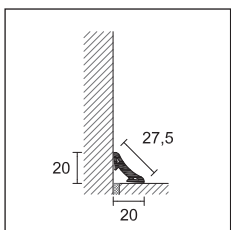

8582

### PVC LINE

length = 250 cm - pack 60 pcs

### FOAM PVC

ART.	decors		decors	
	532	30714	white 555	30730
<b>8582</b>	542	30724	light grey 556	30732
	545	30728	black 557	30734

euro/m

1,11

no partial packaging

For a single piece, see sales conditions on page 288

PVC Line 8602 is an impact-resistant and 48-mm high skirting board in foam PVC. It is particularly suitable for DIY installation, thanks to the speed and easiness of application. It is available in different colours and it is installed with a simple interlocking system with harmonic stainless steel clips. In addition to their decorative function, it allows to hide the expansion gap perimeter of floating wood and laminate floors.

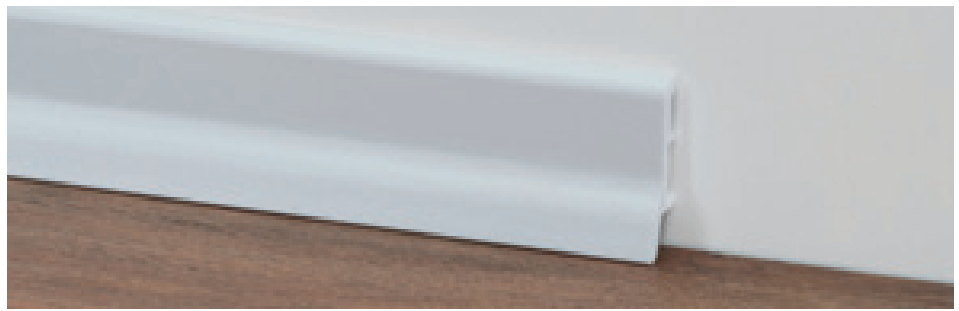

8602 Foam PVC

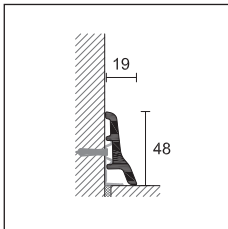

8602

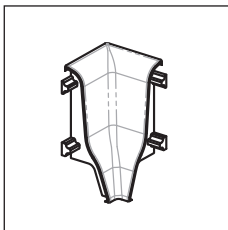

8602/I

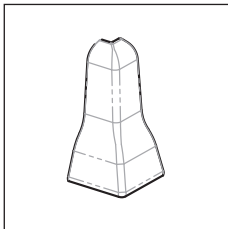

8602/E

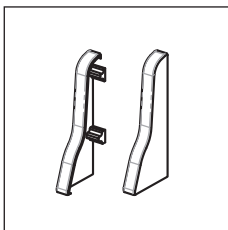

8602/P



8602/C fixing clips

**PVC LINE**

length 250 cm - pack 40 pcs

**FOAM PVC**

H = 48 mm

ART.	decors	
	white 555	29530
8602	light grey 556	29532
	black 557	29534
<b>euro/m</b>		<b>1,49</b>

no partial packaging

**INSIDE CORNER**

pack 10 pcs

**POLYPROPYLENE**

H = 48 mm

ART.	decors	
	white 555	29578
8602/I	light grey 556	29580
	black 557	29582
<b>euro/pc</b>		<b>1,40</b>

no partial packaging

**OUTSIDE CORNER**

pack 10 pcs

**POLYPROPYLENE**

H = 48 mm

ART.	decors	
	white 555	29628
8602/E	light grey 556	29630
	black 557	29632
<b>euro/pc</b>		<b>1,40</b>

no partial packaging

**RIGHT/LEFT END CAPS**

pack 10 pcs

**POLYPROPYLENE**

H = 48 mm

ART.	decors	
	white 555	29728
8602/P dx/sx	light grey 556	29730
	black 557	29732
<b>euro/pc</b>		<b>1,40</b>

no partial packaging

**FIXING CLIPS**

10 blister packs / 20 pcs/blister

8602/C		29750
<b>euro/blister</b>		<b>5,93</b>

For a single piece, see sales conditions on page 288

# skirting board

## pvc line

PVC Line 8603 is an impact-resistant and 70-mm high skirting board in foam PVC. It is particularly suitable for DIY installation, thanks to the speed and easiness of application. It is available in different colours and it can be installed with a simple interlocking system with harmonic stainless steel clips. In addition to its decorative function, it allows to hide the expansion gap perimeter of floating wood and laminate floors.



8603 Foam PVC decor 555

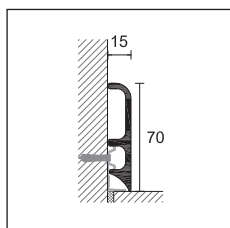

8603

### PVC LINE

length 250 cm - pack 40 pcs

#### FOAM PVC

H = 70 mm

ART.	decors	
	532	30144
	542	30154
	545	30158
8603	white 555	30160
	light grey 556	30162
	black 557	30164

**euro/m** 2,29

no partial packaging

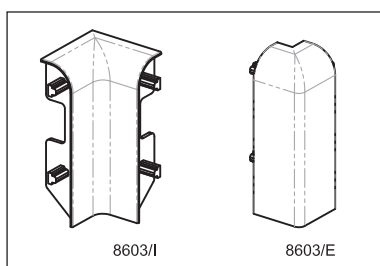

8603/I

8603/E

### INSIDE CORNER

pack 10 pcs

#### POLYPROPYLENE

H = 70 mm

ART.	decors	
	532	30194
	542	30204
	545	30208
8603/I	white 555	30210
	light grey 556	30212
	black 557	30214

**euro/pc** 1,40

no partial packaging

### OUTSIDE CORNER

pack 10 pcs

#### POLYPROPYLENE

H = 70 mm

ART.	decors	
	532	30244
	542	30254
	545	30258
8603/E	white 555	30260
	light grey 556	30262
	black 557	30264

**euro/pc** 1,40

no partial packaging

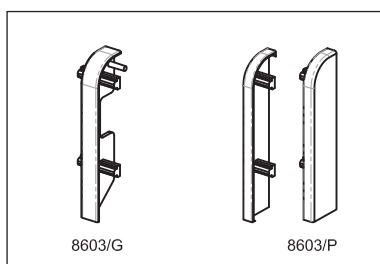

8603/G

8603/P

### JUNCTION

pack 10 pcs

#### POLYPROPYLENE

H = 70 mm

ART.	decors	
	532	30294
	542	30304
	545	30308
8603/G	white 555	30310
	light grey 556	30312
	black 557	30314

**euro/pc** 1,28

no partial packaging

### RIGHT/LEFT END CAPS

pack 10 pcs

#### POLYPROPYLENE

H = 70 mm

ART.	decors	
	532	30344
	542	30354
	545	30358
8603/P dx/sx	white 555	30360
	light grey 556	30362
	black 557	30364

**euro/pc** 1,40

no partial packaging



8602/C fixing clips

### FIXING CLIPS

10 blister packs / 20 pcs/blister

8602/C	29750
<b>euro/blister</b>	<b>5,93</b>



PVC Line 8607 is an impact-resistant and 70-mm high skirting board in foam PVC. It is particularly suitable for DIY installation, thanks to the speed and easiness of application. It is available in different colours and it can be installed with a simple interlocking system with harmonic stainless steel clips. In addition to its decorative use, it allows to hide the expansion gap perimeter of floating wood and laminate floors.



8607 Foam PVC decor 532

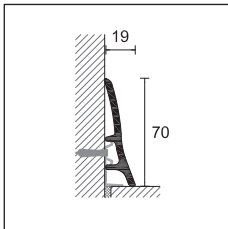

8607

**PVC LINE**

length 250 cm - pack 40 pcs

**FOAM PVC**

H = 70 mm

ART.	decors	
	532	30414
	542	30424
	545	30428
8607	white 555	30430
	light grey 556	30432
	black 557	30434

**euro/m** 2,16

no partial packaging

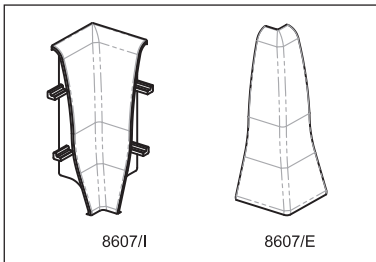

**INSIDE CORNER**

pack 10 pcs

**POLYPROPYLENE**

H = 70 mm

ART.	decors	
	532	30464
	542	30474
	545	30478
8607/I	white 555	30480
	light grey 556	30482
	black 557	30484

**euro/pc** 1,40

no partial packaging

**OUTSIDE CORNER**

pack 10 pcs

**POLYPROPYLENE**

H = 70 mm

ART.	decors	
	532	30514
	542	30524
	545	30528
8607/E	white 555	30530
	light grey 556	30532
	black 557	30534

**euro/pc** 1,40

no partial packaging

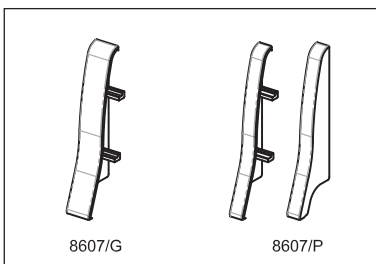

**JUNCTION**

pack 10 pcs

**POLYPROPYLENE**

H = 70 mm

ART.	decors	
	532	30564
	542	30574
	545	30578
8607/G	white 555	30580
	light grey 556	30582
	black 557	30584

**euro/pc** 1,28

no partial packaging

**RIGHT/LEFT END CAPS**

pack 10 pcs

**POLYPROPYLENE**

H = 70 mm

ART.	decors	
	532	30614
	542	30624
	545	30628
8607P dx/sx	white 555	30630
	light grey 556	30632
	black 557	30634

**euro/pc** 1,40

no partial packaging



8602/C fixing clips

**FIXING CLIPS**

10 blister packs / 20 pcs/blister

8602/C 29750

**euro/blister** 5,93

# skirting board

## pvc line

PVC Line 148 is a skirting board for carpet and PVC coverings, composed of a base in rigid PVC and clip in soft PVC. Used as internal corner connection profile, it creates a curvature on the corner once the covering has been laid. It also allows to finish and cover the extremities of the carpet or the PVC covering, thus covering any cutting inaccuracies. This profile is recommended for public spaces such as hospitals and schools.



172 PVC white

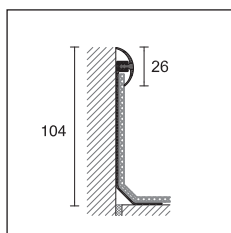

148/B +  
148/C

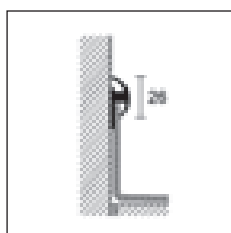

148/BR +  
148/C

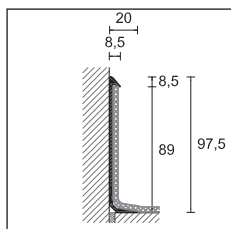

172

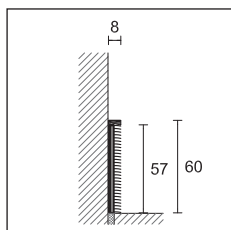

173

### PVC LINE - BASE

length = 300 cm - pack 30 pcs

#### ART. finishing

#### WHITE RIGID PVC

148/B	PVC white	<input type="checkbox"/>	19095
	<i>euro/m</i>		<b>2,59</b>
148/BR	PVC white	<input type="checkbox"/>	19094
	<i>euro/m</i>		<b>1,74</b>

no partial packaging

### PVC LINE - CLIP

length = 305 cm - pack 30 pcs

#### ART. finishing

#### PVC MORBIDO

148/C	PVC white	<input type="checkbox"/>	19096
	PVC ash grey	<input type="checkbox"/>	19097
	PVC sand	<input type="checkbox"/>	19098
	<i>euro/m</i>		<b>2,09</b>

no partial packaging

### PVC LINE

length = 300 cm - pack 20 pcs

#### ART. finishing

#### PVC

172	PVC white	<input type="checkbox"/>	19210
	<i>euro/m</i>		<b>3,82</b>

no partial packaging

length = 300 cm - pack 20 pcs

#### ART. finishing

#### ALUMINIUM

173	silver anodised drilled	<input type="checkbox"/>	19215
	<i>euro/m</i>		<b>6,77</b>

no partial packaging

### MS POLYMER-BASED ADHESIVE FOR SKIRTING BOARDS

quantity 290 ml - pack 24 pcs

PP/96		78301
<i>euro/pc</i>		<b>18,81</b>

output 10/15 m for cartridge

148/C is available in different colours on request

For a single piece, see sales conditions on page 288

PVC Line 170, 169 and 171 are cove-shaped connection profiles in plastic-coated PVC. Recommended for the laying of carpet and PVC coverings, they even out the curvature between the floor and the wall.



171 black PVC

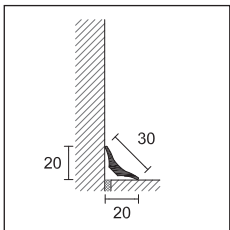

170

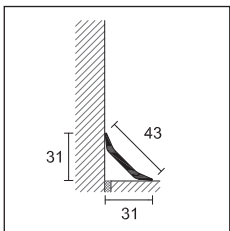

169

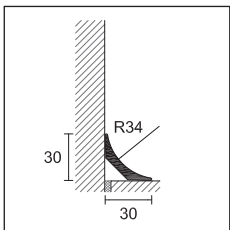

171

**PVC LINE - COVE-SHAPED**

length = 200 cm - pack 50 pcs		H
<b>ART.</b>	<b>finishing</b>	<b>20</b>
<b>PVC</b>		
<b>170</b>	black	19200
	<i>euro/m</i>	<b>1,37</b>

no partial packaging

**PVC LINE - COVE-SHAPED**

length = 200 cm - pack 50 pcs		H
<b>ART.</b>	<b>finishing</b>	<b>31</b>
<b>PVC</b>		
<b>169</b>	black	19195
	<i>euro/m</i>	<b>2,00</b>

no partial packaging

**PVC LINE - COVE-SHAPED**

length = 200 cm - pack 50 pcs		H
<b>ART.</b>	<b>finishing</b>	<b>30</b>
<b>PVC</b>		
<b>171</b>	black	19205
	<i>euro/m</i>	<b>2,52</b>

no partial packaging

All articles PVC line cove-shaped should be stored horizontally.

For a single piece, see sales conditions on page 288





## prolight

Prolight is a line of light profiles with direct and indirect lighting. The integration of the LED technology with Profilpas profiles allows to customize every space. Available in warm, neutral or RGB light and provided with dimmer, they are easy to install and give the suitable light for each use, from the spaces for relaxation to work ones.

Prolight Prolist LLA and LLB are two aluminium decorative listellos with direct LED light. Suitable for framing mirrors and walls and illuminating recessed niches and shelves, these profiles add value to the space, finding an ideal location in bathrooms, kitchens and private space in general. Prolight Prolist LLA/20/10, in particular, is perfect for shower recessed niches to create pleasant plays of light.



LLA/20/10 silver anodised aluminium

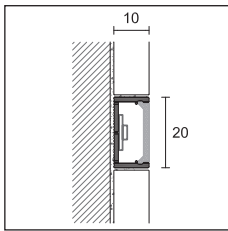

LLA/20

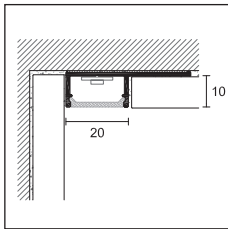

LLA/20/10

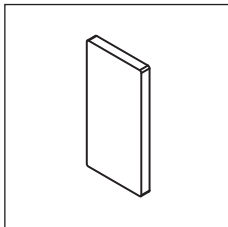

LLA/20P

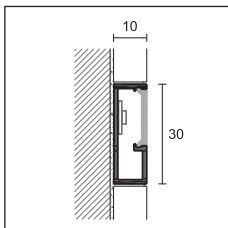

LLA/30  
LLB/30

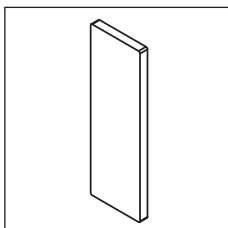

LLA/30P  
LLB/30P

Spare insert in opaline ABS for art. LLA/20, LLA/20/10, LLA/30 and LLB/30 code 84069 L 270 cm - pack 20 pcs euro/m 2,42

For the best aesthetic result and the validity of the warranty, we suggest the exclusive use of our electrical components. See page 240

We recommend the use of NT LED strip with continuous light, see page 240

For a single piece, see sales conditions on page 288

**PROLIGHT PROLIST**

length = 270 cm - pack 10 pcs **LxH**

**ART. finishing** **20x10**

**ALUMINIUM**

<b>LLA/20</b>	silver anodised		84070
	<b>euro/m</b>		<b>8,58</b>

individually packed

**PROLIGHT PROLIST**

length = 270 cm - pack 10 pcs **H**

**ART. finishing** **10**

**ALUMINIUM**

**NEW**

<b>LLA/20/10</b>	silver anodised		84076
	<b>euro/m</b>		<b>12,60</b>

individually packed

**END CAPS FOR LLA/20 AND LLA/20/10**

pack 5 pcs

**ART. finishing**

**ALUMINIUM**

<b>LLA/20P</b>	silver anodised		84072
	<b>euro/pc</b>		<b>6,10</b>

no partial packaging

**PROLIGHT PROLIST**

length = 270 cm - pack 10 pcs **LxH**

**ART. finishing** **30x10**

**ALUMINIUM**

<b>LLA/30</b>	silver anodised		84080
	<b>euro/m</b>		<b>10,40</b>
<b>LLB/30</b>	bright polished silver		84081
	<b>euro/m</b>		<b>13,14</b>

individually packed

**END CAPS FOR LLA/30 AND LLB/30**

pack 5 pcs

**ART. finishing**

**ALUMINIUM**

<b>LLA/30P</b>	silver anodised		84082
	<b>euro/pc</b>		<b>6,10</b>
<b>LLB/30P</b>	bright polished silver		84083
	<b>euro/pc</b>		<b>7,62</b>

no partial packaging

Prolight Prolist TLA is an aluminium decorative listello with indirect LED light, suitable for framing mirrors or outlining walls and coverings.  
Prolight Prolist CLA is ideal under wall cabinets, in kitchens, bathrooms, wardrobes and showcases.

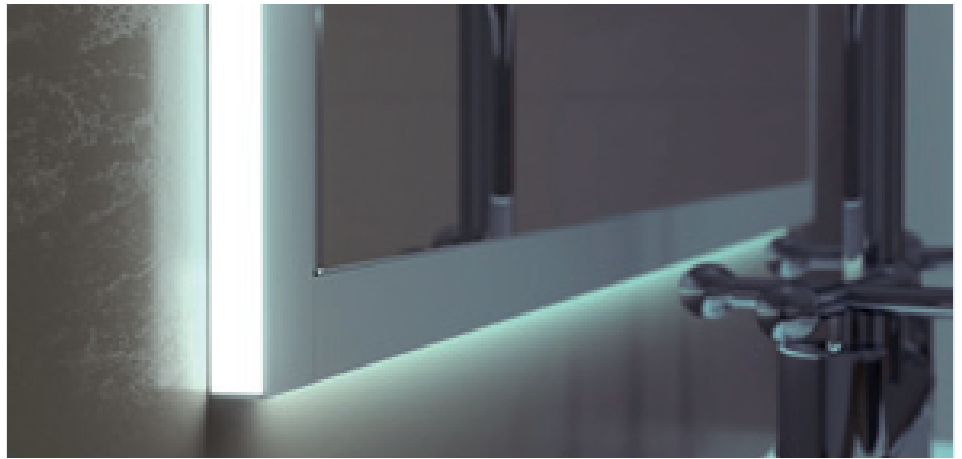

TLA/10/C1 silver anodised aluminium

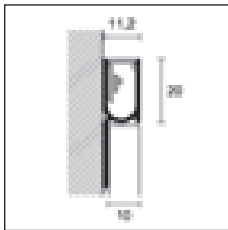

TLA/10/C1  
TLB/10/C1

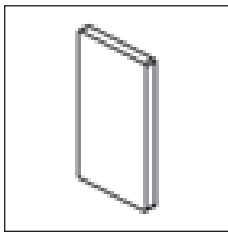

TLA/10P/C1  
TLB/10P/C1

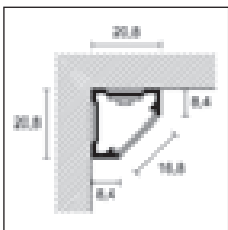

CLA/8  
CLA/8A

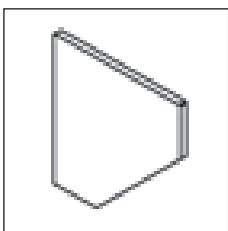

CLA/8P

Spare insert in opaline ABS for art. CLA/8 and CLA/8A code 84069 L 270 cm - pack 20 pcs euro/m 2,42

For the best aesthetic result and the validity of the warranty, we suggest the exclusive use of our electrical components. See page 240

We recommend the use of NT LED strip with continuous light, see page 240

For a single piece, see sales conditions on page 288

**PROLIGHT PROLIST**

length = 270 cm - pack 10 pcs

ART.	finishing		LxH
			<b>20x10</b>
<b>ALUMINIUM</b>			
TLA/10/C1	silver anodised		84090
	euro/m		<b>12,32</b>
TLB/10/C1	bright polished silver		84091
	euro/m		<b>15,09</b>

individually packed

**END CAPS FOR TLA/10/C1**

pack 5 pcs

ART.	finishing		
<b>ALUMINIUM</b>			
TLA/10P/C1	silver anodised		84092
	euro/pc		<b>6,37</b>
TLB/10P/C1	bright polished silver		84093
	euro/pc		<b>8,04</b>

no partial packaging

**PROLIGHT PROLIST**

length = 270 cm - pack 10 pcs

ART.	finishing		H
			<b>8</b>
<b>ALUMINIUM</b>			
CLA/8	silver anodised		84221
	euro/m		<b>11,76</b>
CLA/8A	silver anodised		84222
	adesivo		
	euro/m		<b>15,91</b>

individually packed

**END CAPS FOR CLA/8**

pack 5 pcs

ART.	finishing		H
			<b>8</b>
<b>ALUMINIUM</b>			
CLA/8P	silver anodised		84223
	euro/pc		<b>6,10</b>

no partial packaging

Prolight Prolist Q LQL/2 is an aluminium decorative listello with indirect LED light that, thanks to its particular section, creates a delicate and elegant light effect on the ceramic coverings, thus embellishing the wall. This profile is available in a wide range of colours including white stone, five original cement effects, two special metal tonalities and a white characterized by an extremely solid and full colour.



LQL/2 metal light colour-coated aluminium

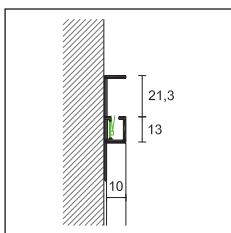

LQL/2









**PROLIGHT PROLIST Q**

length = 270 cm - pack 5 pcs

**H**

**ART. finishing 10**

**COLOUR-COATED ALUMINIUM**

white stone		84020
concrete white		84021
concrete graphite		84022
concrete smoke		84023
<b>LQL/2</b> concrete mud		84024
concrete sand		84025
metal dark		84026
metal light		84027
solid white		84028
<b>euro/m</b>		<b>19,18</b>

individually packed

**ELECTRICAL COMPONENTS AND ACCESSORIES FOR LIGHTING**

ART.	description	
<b>L5/NW/65 L</b>	spool 5 m LED strips, lateral light, neutral colour 4000 °K, 9,6W/m IP65	84136
	<b>euro/mt (euro/pack)</b>	<b>33,13 (165,63)</b>

For the best aesthetic result and the validity of the warranty, we suggest the exclusive use of our electrical components. See page 240

For other electrical components see page 240

For a single piece, see sales conditions on page 288



Prolight Proangle Q ZQAL is a natural aluminium profile for external corners. Equipped with a diffuser in different colours, it helps increasing safety in public and private spaces through a thin luminous line.



ZQAL/10B natural aluminium + ZQAL/10 white opaline PVC

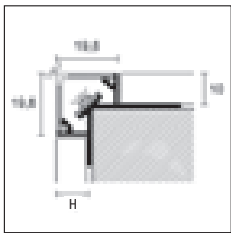

ZQAL/...B+ZQAL/10

**PROLIGHT PROANGLE Q**

length = 270 cm - pack 10 pcs H

ART.	finishing	10	13
------	-----------	----	----

**ALUMINIUM**

ZQAL/10B	natural aluminium base		87226
	<i>euro/m</i>		<b>10,40</b>

ZQAL/13B	natural aluminium base		87227
	<i>euro/m</i>		<b>10,66</b>

**OPALINE PVC**

	white		87230
ZQAL/10	grey		87231
	red		87232
	yellow		87233
	<i>euro/m</i>		<b>8,45</b>

Items available in different colours on demand minimum quantity 540 meters

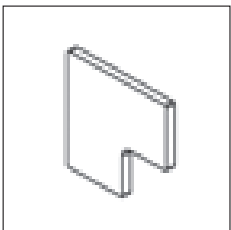

ZQAL/...P

**END CAPS FOR ZQAL**

pack 5 pcs H

ART.	finishing	10	13
------	-----------	----	----

**ALUMINIUM**

ZQAL/10P	natural aluminium		87229
	<i>euro/pc</i>		<b>6,10</b>

ZQAL/13P	natural aluminium		87228
	<i>euro/pc</i>		<b>6,10</b>

no partial packaging

For the best aesthetic result and the validity of the warranty, we suggest the exclusive use of our electrical components. See page 240

We recommend the use of NT LED strip with continuous light, see page 240

For a single piece, see sales conditions on page 288

# cerfix® prostep - protect

Prolight Prostep SGA is an aluminium profile with indirect LED light for the protection and finishing of ceramic, marble and stone steps. With SGA, the light diffuses softly downwards, giving elegance and refinement to the stair, as well as increasing the safety of the space.

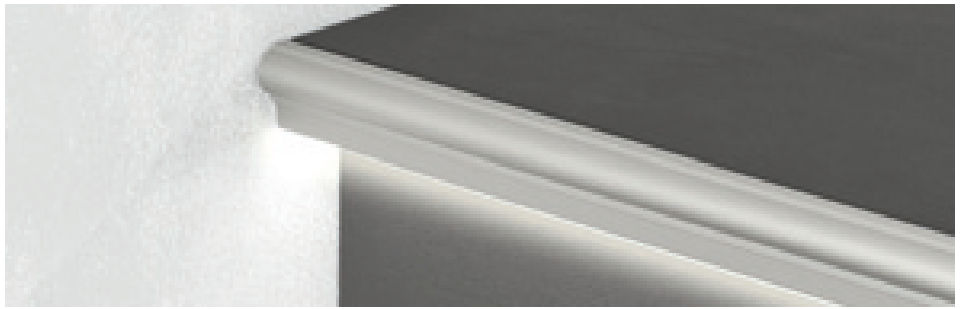

SGA/11L silver anodised aluminium

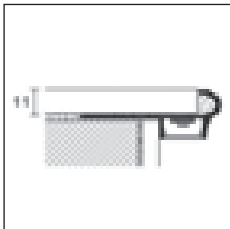

SGA/11L

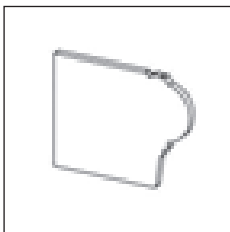

SGA/11P

### PROLIGHT PROSTEP

length = 270 cm - pack 10 pcs		H mm
<b>ART.</b>	<b>finishing</b>	<b>11</b>
<b>ALUMINIUM</b>		
<b>SGA/11L</b>	silver anodised <i>euro/m</i>	94969 <b>17,12</b>
individually packed		

### END CAPS FOR PROFILE SGA/11L

pack 5 pcs		H mm
<b>ART.</b>	<b>finishing</b>	<b>11</b>
<b>ALUMINIUM</b>		
<b>SGA/11P</b>	silver anodised <i>euro/pc</i>	94964 <b>8,87</b>
no partial packaging		

Prolight Protect G/9 is a stair nosing profile in aluminium equipped with direct LED light and a non-slip knurled surface. G/9 is suitable for public spaces such as cinemas, offices, theatres, clubs and boats, making them welcoming and elegant at the same time.



G/9/SF silver anodised aluminium

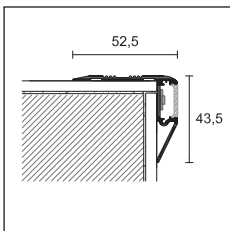

G/9/F

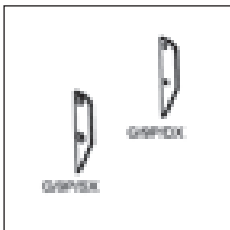

G/9P/

Spare insert in opaline ABS for art. SGA/11L and G/9/F code 84069 L 270 cm - pack 20 pcs euro/m 2,42

For the best aesthetic result and the validity of the warranty, we suggest the exclusive use of our electrical components. See page 240

We recommend the use of NT LED strip with continuous light, see page 240

For a single piece, see sales conditions on page 288

### PROLIGHT PROTECT

length = 270 cm - pack 10 pcs		
<b>ART.</b>	<b>finishing</b>	
<b>ALUMINIUM</b>		
<b>G/9/F</b>	silver anodised <i>euro/m</i>	84050 <b>17,43</b>
individually packed		

### END CAPS FOR PROFILE G/9/F

pack 5 pcs		
<b>ART.</b>	<b>finishing</b>	
<b>ALUMINIUM</b>		
<b>G/9P/DX</b>	silver anodised <i>euro/pc</i>	84052 <b>7,49</b>
<b>G/9P/SX</b>	silver anodised <i>euro/pc</i>	84053 <b>7,49</b>
no partial packaging		

Prolight Protect 126/L/F is an aluminium stair nosing profile equipped with direct LED light and replaceable rubber insert. 126/L/F is suitable for public spaces such as cinemas, offices, theatres, clubs and boards, making them welcoming and elegant at the same time.



126/L/F silver anodised aluminium + GMR/44 black striped rubber

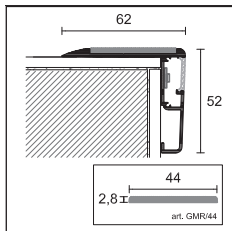

126/L/F

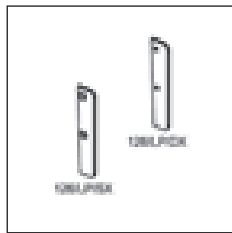

126/LP

**PROLIGHT PROTECT**

length = 270 cm - pack 6 pcs

**ART. finishing**

**ALUMINIUM**

<b>126/L/F</b>	silver anodised		84060
	<i>euro/m</i>		<b>20,19</b>

individually packed

**GROOVED RUBBER**

length = 1700 cm - 1 rolls pack

**ART.**

<b>GMR/44</b>	black		75706
	<i>euro/m</i>		<b>6,30</b>

**END CAPS FOR 126/L/F**

pack 5 pcs

**ART. finishing**

**ALUMINIUM**

<b>126/LP/DX</b>	silver anodised		84062
	<i>euro/pc</i>		<b>7,49</b>
<b>126/LP/SX</b>	silver anodised		84063
	<i>euro/pc</i>		<b>7,49</b>

no partial packaging

Spare insert in opaline ABS for art. 126/L/F code 84069 L 270 cm - pack 20 pcs euro/m 2,42

For the best aesthetic result and the validity of the warranty, we suggest the exclusive use of our electrical components. See page 240

We recommend the use of NT LED strip with continuous light, see page 240

For a single piece, see sales conditions on page 288



# metal line S

Prolight Metal Line SKL/2 is a skirting board in aluminium with indirect LED light. Its special section allows to create an original play of light along the wall, thus adding value to the whole surface. In addition to the silver anodised and the white stone versions, SKL/2 is available in 8 finishes: a range of colours including five original cement effects, two special metal tonalities and a white characterized by an extremely solid and full colour.

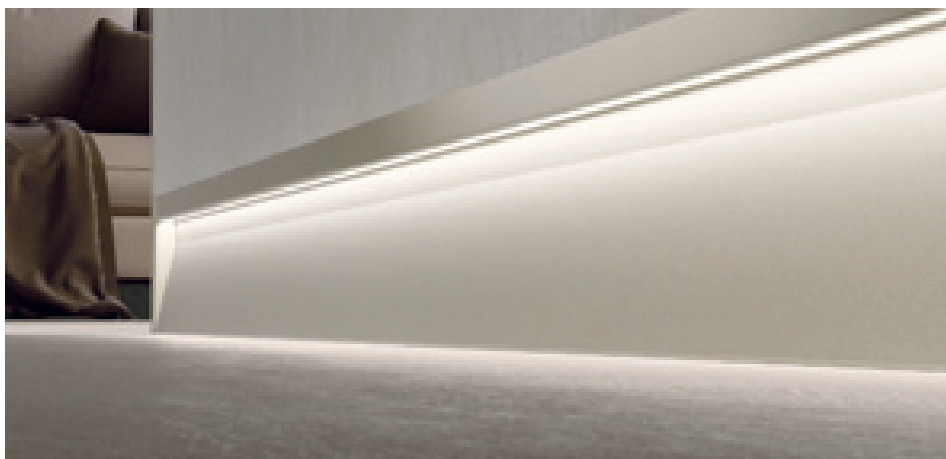

SKL/2 concrete white colour-coated aluminium

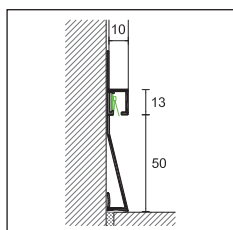

SKL/2

### PROLIGHT METAL LINE S

length = 270 cm - pack 5 pcs

H

ART. finishing

10

#### ALUMINIUM

SKL/2	silver anodised	78579
	euro/m	14,74

#### COLOUR-COATED ALUMINIUM

SKL/2	white stone	78591
	concrete white	78592
	concrete graphite	78593
	concrete smoke	78594
	concrete mud	78595
	concrete sand	78596
	metal dark	78597
	metal light	78598
	solid white	78599
	euro/m	25,28

individually packed

### ELECTRICAL COMPONENTS AND ACCESSORIES FOR LIGHTING

ART.	description	
L5/NW/65 L	spool 5 m LED strips, lateral light, neutral colour 4000 °K, 9,6W/m IP65	84136
	euro/mt (euro/pack)	33,13 (165,63)

For the best aesthetic result and the validity of the warranty, we suggest the exclusive use of our electrical components. See page 240

For other electrical components see page 240

For a single piece, see sales conditions on page 288

Metal Line 88/I6L/A is a skirting board flush with the wall and with LED lighting system. The light is distributed along the whole length of the profile and passes through a visible gap. There is the possibility to insert the optional dimmer to adjust the light intensity of the skirting board and create both an elegant decoration and a night courtesy light.



88/I6L/A silver anodised aluminium

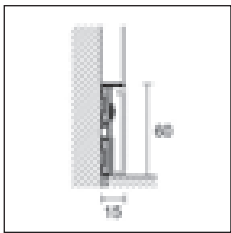

87/6 + 88/I6L

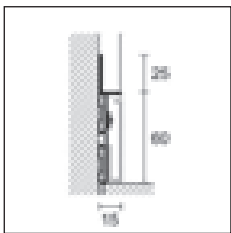

88/6 + 88/I6L

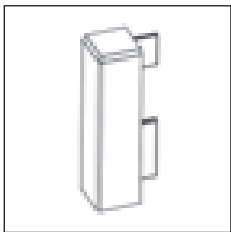

88/6E

**METAL LINE 87 - 88**

length = 200 cm - pack 20 pcs **H cm**

**ART. finishing** **6**

**ALUMINIUM**

<b>87/6</b>	natural aluminium (drilled)		78338
	<i>euro/m</i>		<b>11,41</b>
<b>88/6</b>	natural aluminium (drilled)		78310
	<i>euro/m</i>		<b>13,59</b>

individually packed

**ALUMINIUM INSERT FOR LED LIGHT**

length = 200 cm - pack 20 pcs **H cm**

<b>88/I6L/A</b>	silver anodised		78559
	colour-coated matt white RAL 9010		78560
	<i>euro/m</i>		<b>10,83</b>

adesivo - individually packed

**OUTSIDE CORNER IN METAL**

pack 4 pcs **H cm**

<b>ART. finishing</b>	<b>6</b>		
<b>88/6E</b>	silver		78561
	colour-coated matt white RAL 9010		78562
	<i>euro/pc</i>		<b>10,12</b>

no partial packaging

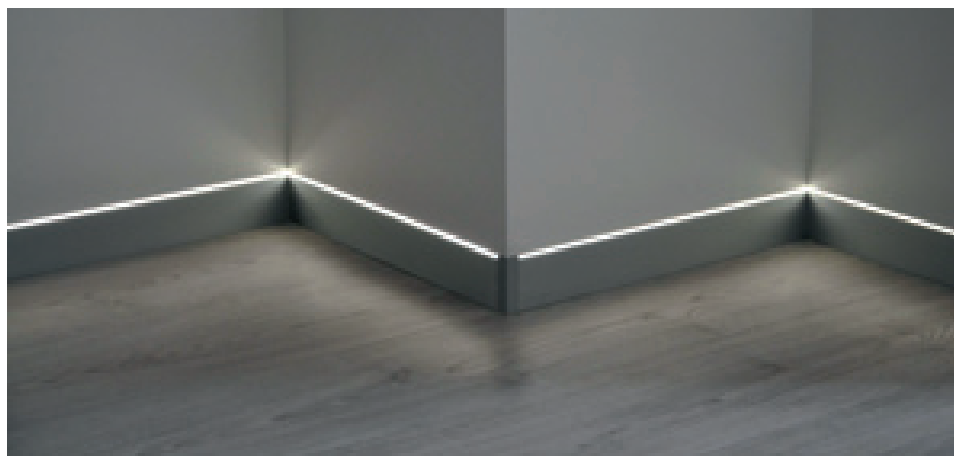

88/6 + 88/I6L/A silver anodised aluminium

For the best aesthetic result and the validity of the warranty, we suggest the exclusive use of our electrical components. See page 240

For a single piece, see sales conditions on page 288

# metal line

Prolight Metal Line 89 is a skirting board in anodised aluminium with LED-strip lighting system. The light is distributed along the entire length of the profile through a diffuser element. It is possible to insert the dimmer in order to adjust the luminous intensity of the skirting board to decorate and light up the room.

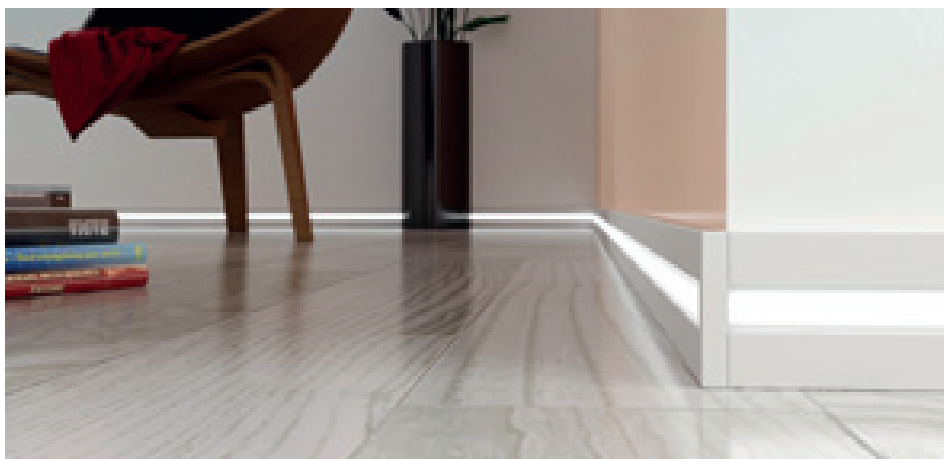

89/6L silver anodised aluminium

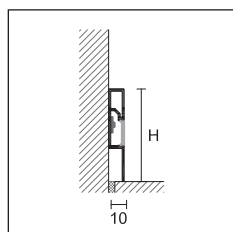

89/6L

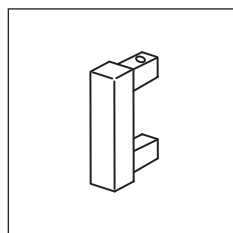

89/6EI

### PROLIGHT METAL LINE 89

length = 200 cm - pack 25 pcs

H cm

ART. finishing

6

#### ALUMINIUM

89/6L silver anodised

86000

euro/m

14,66

individually packed

### INSIDE/OUTSIDE CORNER - RIGHT/LEFT END CAP

pack 4 pcs

H cm

ART. finishing

6

#### ALUMINIUM

89/6EI silver anodised

78506

euro/pc

10,28

no partial packaging

Spare insert in opaline ABS for art. 89/6L code 84069 L 270 cm - pack 20 pcs euro/m 2,42

For the best aesthetic result and the validity of the warranty, we suggest the exclusive use of our electrical components. See page 240

We recommend the use of NT LED strip with continuous light, see page 240

For a single piece, see sales conditions on page 288

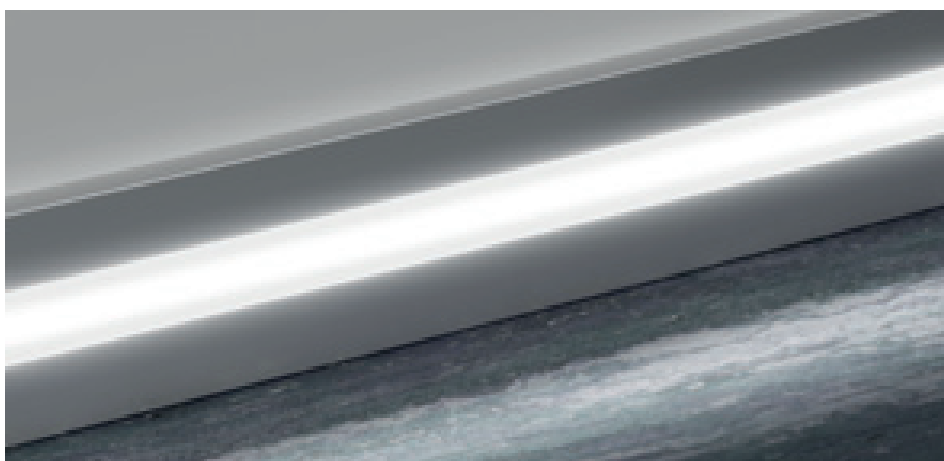

89/6L silver anodised aluminium

## HOW TO ORDER THE ELECTRICAL COMPONENTS

### LED (white light)

Measure how many meters of LED strip have to be positioned on our profiles. A spool is 5 meters long. Spools have 120 LED every meter. The voltage is 24 volt. The consumption is 9,6 watts every meter. To determine the consumption, length must be multiplied by 9,6 watts.

*Example: calculation of the watts consumption = 7,4m x 9,6W = 71 total watts*

Choose the colour of the light. LED strips are available in neutral white light (4000 °K) or warm white light (3000 °K).

Choose the degree of protection: IP33 for inside and dry spaces, IP67 for outside or moist spaces.

### POWER SUPPLIES

Choose the suitable power supply on the basis of the total watts and so as not to exceed 90% of the maximum power.

*Example: 71W : 90 x 100 = 79W - use a power supply of 90W*

	ART.		
from 5 cm to 5,5 m	60W	AL/60/24	84150
from 5,6 m to 8,4 m	90W	AL/90/24	84152
from 8,5 m to 11,2 m	120W	AL/120/24	84154
from 11,3 m to 14 m	150W	AL/150/24	84156

We recommend to power the LED strips every 3 meters in order to avoid differences in brightness and the overheating of the LED in the initial part of them. A cable with 1 mm<sup>2</sup> section has a maximum range of about 4 Amp and a voltage drop of 1 Volt every 10 meters. For special installations, please contact our Technical Department.

### DIMMER (optional)

The dimmer/fader/driver has the function to adjust the light intensity of LED light, it supports maximum 10 Amp to an equal extent of 25 linear meters of our LED strip. It must be placed between the power supply and the LED strip and connected to a switch (not supplied) and/or to the receiver of the remote control (optional).

In case of more lines with simultaneous turning on, the first dimmer is connected in Sync mode and it will switch on the consecutive dimmers.

*Example: to connect 3 lines with simultaneous turning on, you need to use 3 dimmers.*

### REMOTE CONTROL + RECEIVER (optional)

The remote control is a radiofrequency and can control up to 4 channels; it is used to turn on/off the LED.

The receiver must be installed between the power supply and the LED strip or connected to the dimmer if present.

If there is also the dimmer, the remote control can adjust the LED light intensity.

### ELECTRICAL CABLES

The cables are necessary to connect the power supply to the LED strips where needed.

A cable with 1 mm<sup>2</sup> section has a maximum range of about 4 amps and a voltage drop of 1 volt every 10 meters.

### CONNECTORS

Art. IR/C01 connects the LED strips to the line of power supply.  
Art. IR/W3 connects maximum 3 cables among them.

### LED RGB (coloured light)

Measure how many meters of LED strip have to be positioned on our profiles. A spool is 5 meters long. Spools can be cut every 10 cm. The voltage is 24 volt. The consumption is 14,4 watts every meter. To determine the consumption, length must be multiplied by 14,4 watts.

*Example: calculation of the watts consumption = 7,4m x 14,4W = 106,6 total watts*

RGB LED strips are available in degree of protection IP67, are covered with silicone sheath and are provided with adhesive for the fastening in inside or outside spaces.

### POWER SUPPLIES

Choose the suitable power supply on the basis of the total watts and so as not to exceed 90% of the maximum power.

*Example: 106,60W : 90 x 100 = 118W - use a power supply of 120W*

	ART.		
from 10 cm to 3,7 m	60W	AL/60/24	84150
from 3,8 m to 5,5 m	90W	AL/90/24	84152
from 5,6 m to 7,5 m	120W	AL/120/24	84154
from 7,6 m to 9,3 m	150W	AL/150/24	84156

We recommend to power the LED strips every 3 meters in order to avoid differences in brightness and the overheating of the LEDs in the initial part. A cable with 1 mm<sup>2</sup> section has a maximum range of about 4 amp and a voltage drop of 1 volt every 10 meters. For length over 9,3 meters, see SLAVE paragraph. For special installations, please contact our Technical Department.

### REMOTE CONTROL

The remote control is a radiofrequency and can control up to 4 channels; it is used to turn on/off the LED, adjust light intensity and choose the colour or the sequence of LEDs.

### MASTER CONTROL UNIT

Connected with the remote control, it is used to turn on/turn off/adjust light intensity and to choose the colour or the sequence of LEDs.

It must be connected between the power supply and the LED strip.

### SLAVE CONTROL UNIT

Every time that the system needs more lines controlled by just one unit, there is the need to add 1 slave for every added line.

*Example: to connect 3 lines with simultaneous lighting, you need to use 1 master control unit and 2 slave control units.*

The slave control unit must be connected to the master control unit with RJ11 6-poles cable (not supplied).

### ELECTRICAL CABLES

The cable has 4 poles, 3 of them have a 0,5 mm<sup>2</sup> section (for the three colours), one of them has a 1 mm<sup>2</sup> section (for the negative pole).

### CONNECTORS

Art. IR/C02 connects the LED strips with coloured light to the line of power supply, length of 15 cm.  
Art. IR/C03 connects LED strips to LED strips with coloured light, length of 15 cm.

We recommend to assign the assembly of the electrical components to qualified staff.

Electrical components and accessories for Prolight profiles. Each element has to be chosen depending on the established length of the light profiles. It is necessary to calculate the power consumption in W/m for choosing one or more power supplies to be combined with the dimmer and the controller.



spool 5 m NT LED strip



L5/.../33

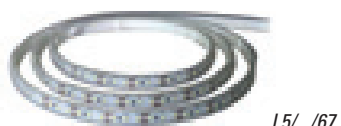

L5/.../67



AL/.../24



DIMM/02



TEL/04



TEL/RGB/04



RIC/01

### ELECTRICAL COMPONENTS AND ACCESSORIES FOR LIGHTING

ART.	description	
L5/NW/33	spool 5 m LED strip colour neutral white 4000° K - 9,6W/m - IP33 <i>euro/m (euro/pack)</i>	84105 <b>16,30 (81,50)</b>
L5/WW/33	spool 5 m LED strip colour warm white 3000° K - 9,6W/m - IP33 <i>euro/m (euro/pack)</i>	84115 <b>16,30 (81,50)</b>
L5/NW/67	spool 5 m LED strip colour neutral white 4000° K - 9,6W/m - IP67 <i>euro/m (euro/pack)</i>	84125 <b>25,34 (126,68)</b>
L5/WW/67	spool 5 m LED strip colour warm white 3000° K - 9,6W/m - IP67 <i>euro/m (euro/pack)</i>	84135 <b>25,34 (126,68)</b>
L5/RGB/67	spool 5 m RGB LED strip - 14,4 W/m - IP67 <i>euro/m (euro/pack)</i>	84140 <b>33,13 (165,63)</b>
<b>NEW</b> L5/NW/65NT	spool 5 m NT LED strip neutral white colour 4000° K - 10W/m - IP65 <i>euro/m (euro/pack)</i>	84118 <b>32,87 (164,37)</b>
<b>NEW</b> L5/NW/67NT	spool 5 m NT LED strip neutral white colour 4000° K - 10W/m - IP67 <i>euro/m (euro/pack)</i>	84122 <b>40,33 (201,66)</b>
AL/60/24	power supply IP67 - PFC active - 24Vdc/60W <i>euro/pc</i>	84150 <b>82,92</b>
AL/90/24	power supply IP67 - PFC active - 24Vdc/90W <i>euro/pc</i>	84152 <b>132,36</b>
AL/120/24	power supply IP67 - PFC active - 24Vdc/120W <i>euro/pc</i>	84154 <b>239,51</b>
AL/150/24	power supply IP67 - PFC active - 24Vdc/150W <i>euro/pc</i>	84156 <b>367,02</b>
DIMM/02	dimmer/driver 24V/10 Amp - dim. mm 57x44x19 h. for white LED light <i>euro/pc</i>	84187 <b>83,52</b>
TEL/04	4- channel radio frequency remote control <i>euro/pc</i>	84182 <b>72,66</b>
RIC/01	4- remote control receiver radio frequency <i>euro/pc</i>	84184 <b>145,35</b>
TEL/RGB/04	4 channel radiofrequency remote control 433,92MHz for RGB LED diam. 80x13 h <i>euro/pc</i>	84183 <b>167,69</b>





RIC/RGB/...



CE/5/20  
CE/10/...



CE/RGB/20

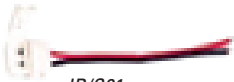

IR/C01

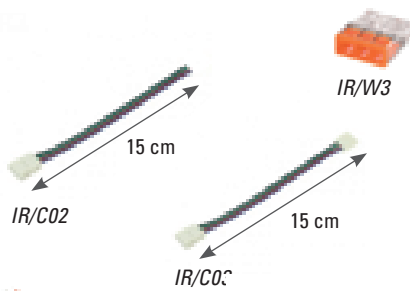

IR/W3

IR/C02

IR/C02

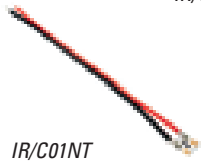

IR/C01NT



IR/C01NT

NEW

<b>RIC/RGB/M</b>	master control unit with dimmer functiona/wireless for RGB LED diam. 174x46x35 h <i>euro/pc</i>	84185 <b>393,51</b>
<b>RIC/RGB/S</b>	slave control unit whit dimmer function for RGB LED (maximum 4 slave for each master) <i>euro/pc</i>	84186 <b>274,92</b>
<b>CE/5/20</b>	electrical cable sect. 0,5 mm <sup>2</sup> - pack 20 ml <i>euro/m</i>	84420 <b>2,00</b>
<b>CE/10/20</b>	electrical cable sect. 1 mm <sup>2</sup> - pack 20 ml <i>euro/m</i>	84422 <b>2,00</b>
<b>CE/10/100</b>	electrical cable sect. 1 mm <sup>2</sup> - pack 100 ml <i>euro/m</i>	84424 <b>1,56</b>
<b>CE/RGB/20</b>	electrical cable for RGB LED section 3x0,5 mm <sup>2</sup> + 1x1 mm <sup>2</sup> - pack 20 m <i>euro/m</i>	84426 <b>9,22</b>
<b>IR/C01</b>	rapid fit connector for strip LED white light - pack 10 pcs <i>euro/pc</i>	84411 <b>3,89</b>
<b>IR/W3</b>	rapid fit connector 3 cables - pack 10 pcs <i>euro/pc</i>	84410 <b>0,63</b>
<b>IR/C02</b>	rapid fit connector RGB LED strip - pack 10 pcs <i>euro/pc</i>	84415 <b>4,10</b>
<b>IR/C03</b>	rapid fit double connector RGB LED strip - pack 10 pcs <i>euro/pc</i>	84416 <b>6,22</b>
<b>IR/C01NT</b>	rapid fit connector for NT LED strip white light - pack 10 pcs <i>euro/pc (euro/pack)</i>	84413 <b>2,33 (23,30)</b>





## entrance mats

Promat is a modular technical mat designed for both public and private use. Thanks to its easy assembly with a simple interlocking system, Promat does not need specific expertise and can be assembled directly on site. Promat is available in three insert solutions: carpet, brushes or rubber. In this way, it guarantees the cleaning and the protection of floors against dust, filth in general and water.

# promat

available from September 2022

Promat is a modular technical mat, which can be customized and created in any size directly on site, allowing maximum operational flexibility.

The installation of Promat is easy and quick thanks to the interlocking system with silver anodised aluminium profiles, already equipped with inserts in black carpet, rubber or brushes. The carpet insert, recommended for internal use, absorbs finer dirt and water, and also aids drying when passing through.

The rubber insert is resistant to atmospheric agents, making it ideal for outdoor use, removes coarse dirt and also has a non-slip function. Lastly, the brushes insert is suitable for outdoor installation in area of high pedestrian traffic thanks to its ability to remove the most difficult dirt.

Promat can be installed recessed or overlapped on existing floors according to the needs. In case of overlapping installation, there is the possibility to insert the ramp profile for facilitating the access.

Promat is also available in two already-assembled and ready-for-use versions in a choice of carpet or rubber/brush mix, in sizes 70x39,5 cm and 90x49,5 cm.



available from September 2022

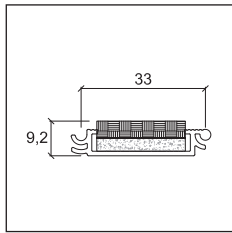

ZT/307/MN

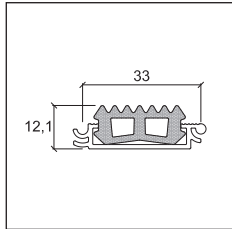

ZT/307/GN

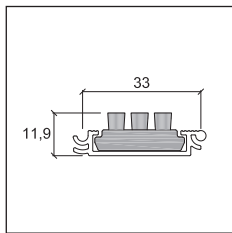

ZT/307/SN

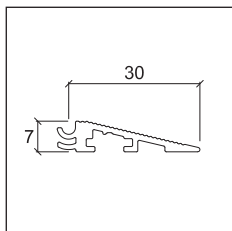

ZT/307/R1

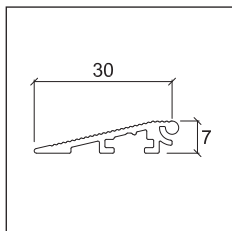

ZT/307/R2

**NEW PROMAT**

length = 270 cm - pack 10 pcs

ART.		90400	90401	90402	90403	90404	Conf.
ZT/307/MN	silver anodised aluminium profile + black carpet insert						10
ZT/307/GN	silver anodised aluminium profile + black rubber insert						10
ZT/307/SN	silver anodised aluminium profile + black brushes insert						10
ZT/307/R1	silver anodised aluminium right ramp profile						10
ZT/307/R2	silver anodised aluminium left ramp profile						10

individually packed

**NEW ACCESSORIES**

ART.		90405	Conf.
ZT/307/NA	adhesive tape in black EPDM 20 m		1

no partial packaging

**NEW PROMAT - READY-MADE MAT**

ART.		90407	90408	90409	90410	Conf.
ZT/307/01	ready-made mat dim. 70x39,5 cm with profiles with black carpet inserts					
ZT/307/02	ready-made mat dim. 70x39,5 cm with profiles with black rubber and brushes inserts					
ZT/307/03	ready-made mat dim. 90x49,5 cm with profiles with black carpet inserts					
ZT/307/04	ready-made mat dim. 90x49,5 cm with profiles with black rubber and brushes inserts					

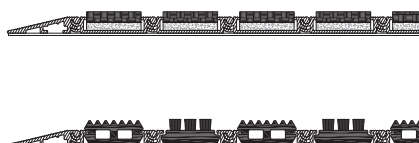





## supports for raised floors

With the new supports for raised floors PP Level Duo® by Profilpas, there is the possibility to choose between fixed and self-levelling head in an instant, directly during the installation.

A choice that can be made easily, thanks to the special converter Perfect Ring. Indeed, if you insert it between the head and the screw, the support becomes fixed. On the contrary, if there is the need to compensate the slope of a surface up to 6%, it will be sufficient not to insert the ring to obtain a self-levelling system.

# pp level duo® - complete support

## PPlevelDUO®



- speed of installation: just 5 seconds to assemble the support.
- height adjustment from the top through adjustment key.
- adjustable supports with wide excursion of available heights.
- the solid and blunt base impedes the incision of the waterproofing membrane.
- acoustic insulation: noise-proof rubber intergated with the head.
- a system of draining holes and canalizations impedes the stagnation of water in every part of the support.
- solid support base of 340 cm<sup>2</sup> for a better distribution of the weight.
- precise adjustment of the slope to guarantee a perfect flat surface.
- usable in spaces with temperatures from - 40° C to + 80° C.
- pre-cut tabs for 2, 3 and 4 mm joints.
- ecological: all the support is made of recyclable plastic materials.
- NEW** ● stackable extension of 10 mm thickness. It allows to increase the overall height in combination with PP Level DUO or PP Level FIX, assembling two or more elements through the specific plugs.





# pp level duo® - complete support



25/37/4



37/61/4



60/105/4



94/169/4



150/280/4



239/320/4

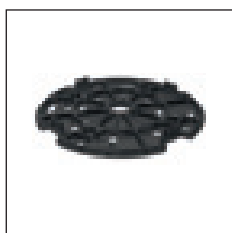

P1/10

## PP LEVEL DUO® - HEAD + SCREW + BASE

head for 4-mm joints - tabs H 12 mm

ART.			pack	pallet
25/37/4	head + screw + base adjustable from h 25 to 37 mm	19360	25 pcs	1250 pcs
	<i>euro/pc (euro/pack)</i>	<b>3,63 (90,75)</b>		
37/61/4	head + screw + base adjustable from h 37 to 61 mm	19361	25 pcs	900 pcs
	<i>euro/pc (euro/pack)</i>	<b>4,65 (116,25)</b>		
60/105/4	head + screw + base adjustable from h 60 to 105 mm	19362	25 pcs	500 pcs
	<i>euro/pc (euro/pack)</i>	<b>4,99 (124,75)</b>		
94/169/4	head + screw + base adjustable from h 94 to 169 mm	19363	25 pcs	400 pcs
	<i>euro/pc (euro/pack)</i>	<b>5,46 (136,50)</b>		
150/280/4	head + screw + base adjustable from h 150 to 280 mm	19364	25 pcs	300 pcs
	<i>euro/pc (euro/pack)</i>	<b>6,11 (152,75)</b>		
239/320/4	head + screw + extension element + base adjustable from h 239 to 320 mm	19365	25 pcs	300 pcs
	<i>euro/pc (euro/pack)</i>	<b>8,79 (219,75)</b>		

no partial packaging

## EXTENSION FOR PP LEVEL DUO®

ART.			pack	pallet
P1/80	extension element h 80 mm	19380	25 pcs	500 pcs
	<i>euro/pc (euro/pack)</i>	<b>3,14 (78,50)</b>		
<b>NEW</b> P1/10	extension element h 10 mm	19369	15 pcs	-
	<i>euro/pc (euro/pack)</i>	<b>1,20 (18,00)</b>		

no partial packaging

art. 239/320/4 cod. 19365		1 pcs	1 pcs	1 pcs	1 pcs	1 pcs	1 pcs	1 pcs	1 pcs	1 pcs
art. P1/80 cod. 19380		1 pcs	2 pcs	3 pcs	4 pcs	5 pcs	6 pcs	7 pcs	8 pcs	9 pcs

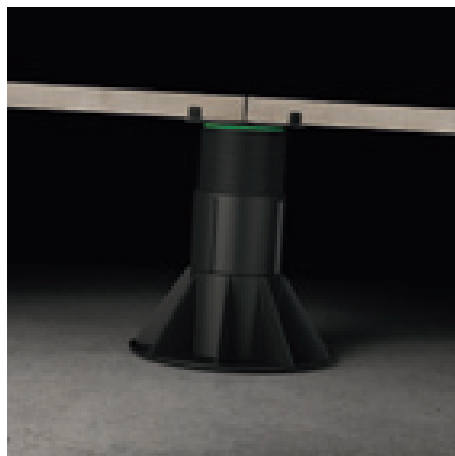

with Perfect Ring, the support is fixed



without Perfect Ring, the support is self-levelling

# pp level duo® - modular support

## PP level DUO® - Other heads

PP Level DUO® supports are extremely versatile thanks to the possibility to choose between different heads for ceramic tiles (with 2, 3 and 4 mm tabs) or decking. Each head can be combined with any adjustable base.

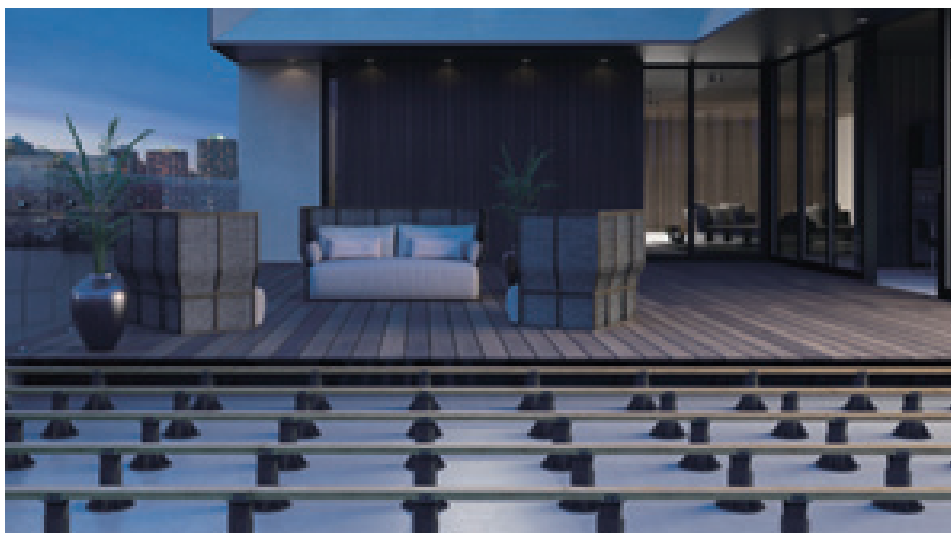

PPL/TD

### PP LEVEL DUO® - HEAD FOR DECKING

PP LEVEL DUO® - HEAD FOR DECKING				
ART.			pack	pallet
PPL/TD	head for decking	19399	25 pcs	500 pcs
	<i>euro/pc (euro/pack)</i>	<b>1,25 (31,25)</b>		
no partial packaging				



PPL/5030/T +  
PPL/TD/TT

### NEW PP LEVEL DUO® - JOIST FOR DECKING

length 200 cm

NEW PP LEVEL DUO® - JOIST FOR DECKING				
ART.			pack	pallet
PPL/5030/T	joist for decking section 50x30x2 mm	19389	8 pcs	160 pcs
	<i>euro/m (euro/pack)</i>	<b>13,71 (219,36)</b>		
no partial packaging				

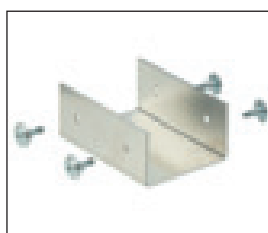

PPL/TD/GR

### NEW PP LEVEL DUO® - ACCESSORIES FOR JOISTS FOR DECKING

NEW PP LEVEL DUO® - ACCESSORIES FOR JOISTS FOR DECKING				
ART.			pack	pallet
PPL/TD/GR	connection for joists for decking	19387	12 pcs	
	<i>euro/pc (euro/pack)</i>	<b>3,43 (41,16)</b>		
PPL/TD/TT	T connection for joists for decking	19388	20 pcs	
	<i>euro/pc (euro/pack)</i>	<b>5,75 (115,00)</b>		
no partial packaging				



PPL/TD/TT

# pp level duo® - modular support

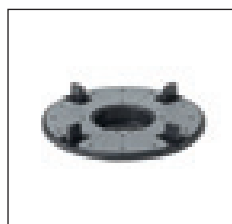

PPL/T2  
PPL/T3  
PPL/T4



25/37/B



37/61/B



60/105/B



94/169/B



150/280/B



239/320/B

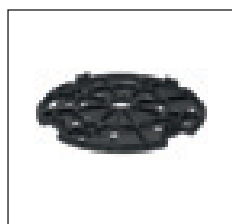

P1/10

## PP LEVEL DUO® - HEAD FOR 2, 3 AND 4 MM JOINTS

ART.			pack	pallet
<b>PPL/T2</b>	head for 2 mm joints	19370	25 pcs	500 pcs
	<i>euro/pc (euro/pack)</i>	<b>1,25 (31,25)</b>		
<b>PPL/T3</b>	head for 3 mm joints	19374	25 pcs	500 pcs
	<i>euro/pc (euro/pack)</i>	<b>1,25 (31,25)</b>		
<b>PPL/T4</b>	head for 4 mm joints	19371	25 pcs	500 pcs
	<i>euro/pc (euro/pack)</i>	<b>1,25 (31,25)</b>		

no partial packaging

## PP LEVEL DUO® - BASE + SCREW

ART.			pack	pallet
<b>25/37/B</b>	base + screw adjustable from h 25 to 37 mm	19390	25 pcs	1250 pcs
	<i>euro/pc (euro/pack)</i>	<b>2,38 (59,50)</b>		
<b>37/61/B</b>	base + screw adjustable from h 37 to 61 mm	19391	25 pcs	900 pcs
	<i>euro/pc (euro/pack)</i>	<b>3,40 (85,00)</b>		
<b>60/105/B</b>	base + screw adjustable from h 60 to 105 mm	19392	25 pcs	500 pcs
	<i>euro/pc (euro/pack)</i>	<b>3,74 (93,50)</b>		
<b>94/169/B</b>	base + screw adjustable from h 94 to 169 mm	19393	25 pcs	400 pcs
	<i>euro/pc (euro/pack)</i>	<b>4,22 (105,50)</b>		
<b>150/280/B</b>	base + screw adjustable from h 150 to 280 mm	19394	25 pcs	300 pcs
	<i>euro/pc (euro/pack)</i>	<b>4,86 (121,50)</b>		
<b>239/320/B</b>	base + screw + extension element adjustable from h 239 to 320 mm	19395	25 pcs	300 pcs
	<i>euro/pc (euro/pack)</i>	<b>7,55 (188,75)</b>		

no partial packaging

## EXTENSION FOR PP LEVEL DUO®

ART.			pack	pallet
<b>P1/80</b>	extension element h 80 mm	19380	25 pcs	500 pcs
	<i>euro/pc (euro/pack)</i>	<b>3,14 (78,50)</b>		
<b>NEW P1/10</b>	extension element h 10 mm	19369	15 pcs	-
	<i>euro/pc (euro/pack)</i>	<b>1,20 (18,00)</b>		

no partial packaging

	H. 25/37/00	H. 37/61/00	H. 47/60/00	H. 55/64/00	H. 63/72/00	H. 71/80/00	H. 78/88/00	H. 87/98/00	H. 95/104/00
art. 239/320/B col. 19395 + base + screw	1 pcs	1 pcs	1 pcs	1 pcs	1 pcs	1 pcs	1 pcs	1 pcs	1 pcs
art. P1/10 col. 19369	1 pcs	2 pcs	3 pcs	4 pcs	5 pcs	6 pcs	7 pcs	8 pcs	9 pcs

For a single piece, see sales conditions on page 288

# pp level duo® - double joist system



## PP level DUO® - double joist system

The aluminium joists system is the ideal solution for the installation of single-format and multiformat ceramic tiles. Thanks to this system, the installation is always precise and, at the same time, guarantees great stability and resistance.

Profilpas double joist system is composed of two joists in natural aluminium that must be fixed on a special head, thus creating a rail for the positioning of the spacer. The spacer, thanks to its removable tabs, guarantees a correct position of the tiles and creates the 4-mm joint.

- the double joist system is not visible from the joint.
- the double joist system avoids water stagnation and the accumulation of dust and filth.
- thanks to the space between the two joists, it is possible to adjust the height of the support through the specific key.

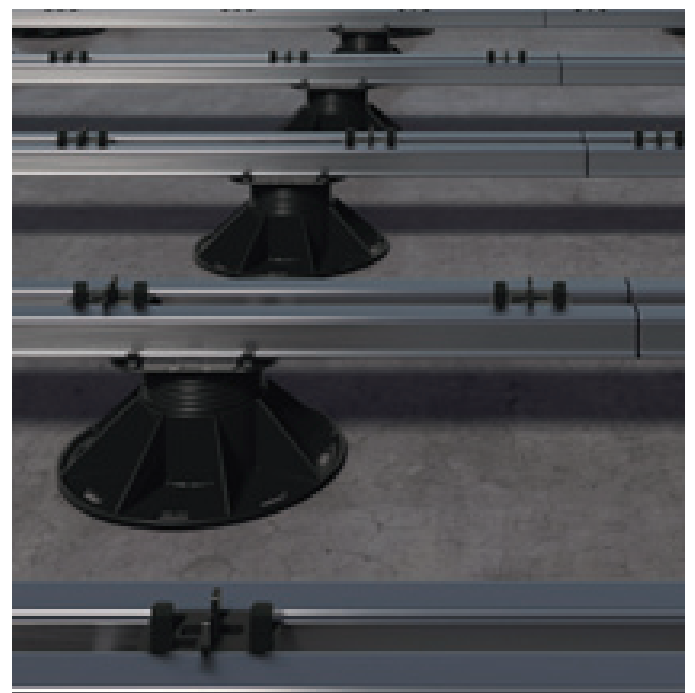

# pp level duo® - double joist system



PPL/TA

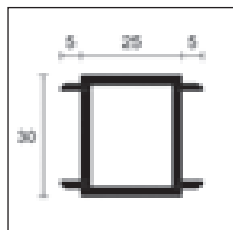

PPL/T

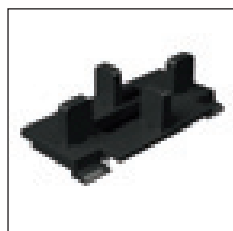

PPL/D4



PPL/GM

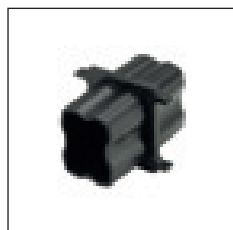

PPL/GR

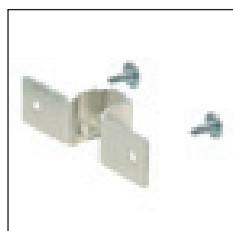

PPL/TT

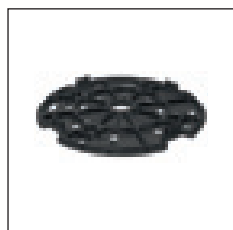

P1/10

## PP LEVEL DUO® - HEAD AND ACCESSORIES FOR THE DOUBLE JOIST SYSTEM

ART.			pack	pallet
<b>PPL/TA</b>	head for aluminium joists	19396	25 pcs	500 pcs
	<i>euro/pc (euro/-pack)</i>	<b>1,40 (35,00)</b>		
<b>PPL/T</b>	aluminium joist L 2000 mm	19397	10 pcs	200 pcs
	<i>euro/m (euro/-pack)</i>	<b>11,69 (233,80)</b>		
<b>PPL/D4</b>	4-mm spacer for aluminium joists	19398	500 pcs	-
	<i>euro/pc (euro/-pack)</i>	<b>0,24 (120,00)</b>		
<b>PPL/GM</b>	noise-proof rubber 20x2 mm - 20 meters roll	19372	5 pcs	-
	<i>euro/m (euro/-pack)</i>	<b>2,32 (232,00)</b>		
<b>PPL/GR</b>	connection for joists	19373	250 pcs	-
	<i>euro/pc (euro/-pack)</i>	<b>0,36 (90,00)</b>		
<b>NEW PPL/TT</b>	T connection for joists	19375	20 pcs	-
	<i>euro/pc (euro/-pack)</i>	<b>6,73 (134,60)</b>		

no partial packaging

The aluminium joists must be installed in pairs.

## PP LEVEL DUO® - BASE + SCREW

ART.			pack	pallet
<b>25/37/B</b>	base + screw adjustable from h 25 to 37 mm	19390	25 pcs	1250 pcs
	<i>euro/pc (euro/-pack)</i>	<b>2,38 (59,50)</b>		
<b>37/61/B</b>	base + screw adjustable from h 37 to 61 mm	19391	25 pcs	900 pcs
	<i>euro/pc (euro/-pack)</i>	<b>3,40 (85,00)</b>		
<b>60/105/B</b>	base + screw adjustable from h 60 to 105 mm	19392	25 pcs	500 pcs
	<i>euro/pc (euro/-pack)</i>	<b>3,74 (93,50)</b>		
<b>94/169/B</b>	base + screw adjustable from h 94 to 169 mm	19393	25 pcs	400 pcs
	<i>euro/pc (euro/-pack)</i>	<b>4,22 (105,50)</b>		
<b>150/280/B</b>	base + screw adjustable from h 150 to 280 mm	19394	25 pcs	300 pcs
	<i>euro/pc (euro/-pack)</i>	<b>4,86 (121,50)</b>		
<b>239/320/B</b>	base + screw + extension element adjustable from h 239 to 320 mm	19395	25 pcs	300 pcs
	<i>euro/pc (euro/-pack)</i>	<b>7,55 (188,75)</b>		

no partial packaging

## EXTENSION FOR PP LEVEL DUO®

ART.			pack	pallet
<b>P1/80</b>	extension element h 80 mm	19380	25 pcs	500 pcs
	<i>euro/pc (euro/-pack)</i>	<b>3,14 (78,50)</b>		
<b>NEW P1/10</b>	extension element h 10 mm	19369	15 pcs	-
	<i>euro/pc (euro/-pack)</i>	<b>1,20 (18,00)</b>		

no partial packaging

	H. 216/400	H. 266/480	H. 476/960	H. 526/1040	H. 636/1200	H. 716/1360	H. 766/1440	H. 876/1600	H. 926/1680
art. 239/320/B cod. 19395 + base e vite	1 pcs	1 pcs	1 pcs	1 pcs	1 pcs	1 pcs	1 pcs	1 pcs	1 pcs
art. P1/80 cod. 19380	1 pcs	2 pcs	3 pcs	4 pcs	5 pcs	6 pcs	7 pcs	8 pcs	9 pcs

For a single piece, see sales conditions on page 288

# pp level fix - complete support

PP Level FIX is a new line of supports with fixed head. Available for heights from 25 to 280 mm, PP Level Fix supports can be adjusted in height from the top, thanks to the specific adjustment key.

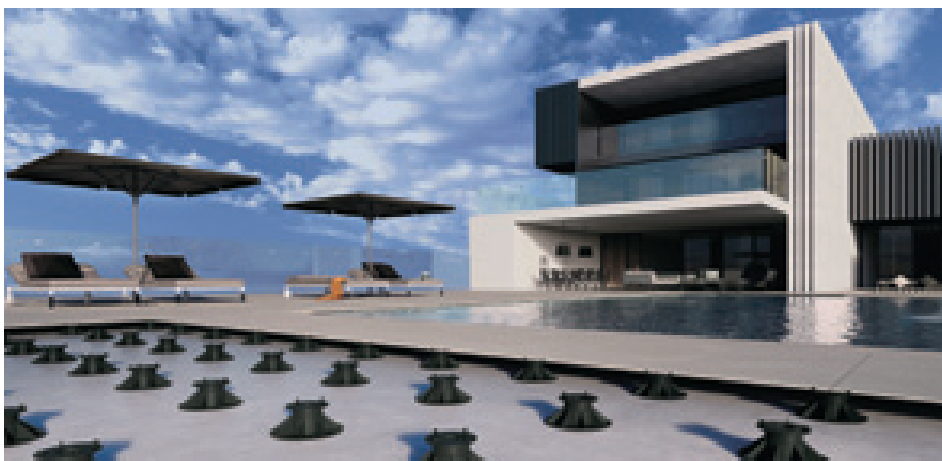

PP Level Fix



25/37/4F



37/61/4F



60/105/4F



94/169/4F



150/280/4F

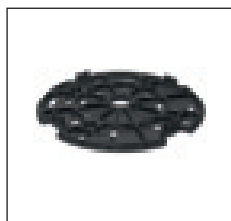

P1/10

## PP LEVEL FIX

head for 4-mm joints - tabs h 12 mm

ART.			pack	pallet
<b>25/37/4F</b>	head + screw + base adjustable from h 25 to 37 mm	19340	25 pcs	1250 pcs
	<i>euro/pc (euro/pack)</i>	<b>2,67 (66,75)</b>		
<b>37/61/4F</b>	head + screw + base adjustable from h 37 to 61 mm	19341	25 pcs	900 pcs
	<i>euro/pc (euro/pack)</i>	<b>3,56 (89,00)</b>		
<b>60/105/4F</b>	head + screw + base adjustable from h 60 to 105 mm	19342	25 pcs	500 pcs
	<i>euro/pc (euro/pack)</i>	<b>3,78 (94,50)</b>		
<b>94/169/4F</b>	head + screw + base adjustable from h 94 to 169 mm	19343	25 pcs	400 pcs
	<i>euro/pc (euro/pack)</i>	<b>4,23 (105,75)</b>		
<b>150/280/4F</b>	head + screw + base adjustable from h 150 to 280 mm	19344	25 pcs	300 pcs
	<i>euro/pc (euro/pack)</i>	<b>4,79 (119,75)</b>		

no partial packaging

## EXTENSION FOR PP LEVEL FIX

ART.			pack	pallet
<b>NEW P1/10</b>	extension element h 10 mm	19369	15 pcs	-
	<i>euro/pc (euro/pack)</i>	<b>1,20 (18,00)</b>		

no partial packaging

PP Level Mini is a support with fixed head, for heights from 10 to 15 mm. With maximum two extension elements P/5, there is the possibility to reach an height of 25 mm.



PP Level Mini



10/15



P/5

**PP LEVEL MINI**

head for 4-mm joints - tabs h 10 mm

ART.		pack	
<b>10/15</b>	adjustable support from h 10 to 15 mm	19351	20 pcs
	<i>euro/pc (euro/pack)</i>	<b>1,72 (34,40)</b>	
<b>P/5</b>	extension element of 5 mm thickness for art. 10/15 (maximum two elements = +10 mm)	19350	20 pcs
	<i>euro/pc (euro/pack)</i>	<b>0,81 (16,20)</b>	

no partial packaging

SP1 is a support to be used for the positioning of grit and concrete slabs. It can be installed with the correctors SP2 and SP3, according to the desired slope of the flooring. SP1 guarantees the outflow of rainwater and allows to avoid the direct contact of the flooring with the possible waterproofing layer.



SP1

**SUPPORT FOR RAISED FLOORS**

pack 360 pcs

ART.		pack	pallet
<b>SP1</b>	support for grit and concrete slabs diam. 155x14 h	19090	360 pcs
	<i>euro/pc (euro/pack)</i>	<b>0,207 (74,19)</b>	5760 pcs

no partial packaging

**CORRECTORS FOR RAISED FLOORS**

pack 1000 pcs

ART.		pack	pallet
<b>SP2</b>	corrector for support SP1 thickness 1 mm	19092	1000 pcs
	<i>euro/pc (euro/pack)</i>	<b>0,204 (203,68)</b>	20000 pcs

pack 500 pcs

ART.		pack	pallet
<b>SP3</b>	corrector for support SP1 thickness 3 mm	19093	500 pcs
	<i>euro/pc (euro/pack)</i>	<b>0,215 (107,40)</b>	15000 pcs

no partial packaging



SP2



SP3

## pp level duo® - accessori

Among the accessories for the installation of outdoor raised floors, in addition to the adjustment key, there are rubber disks, levelling disks and a full system for the creation of steps and vertical risers. PCC/01, PCC/04 and PCC/02 are stainless steel clips to be installed on the head and under the base of perimetral and corner supports: the tile must be positioned between the two clips in order to create a perfect step. This result can be also obtained with PCC/03 and PCC/05, two clips for the installation close to vertical walls that allows to keep always the same distance between the wall and the tiles.



PCC/01 and PCC/02 stainless steel clips

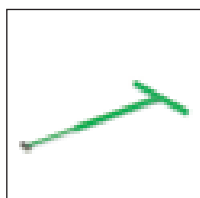

CR/N

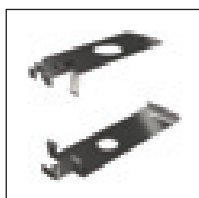

KIT PCC/01

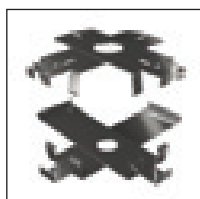

KIT PCC/02

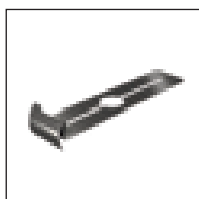

PCC/03

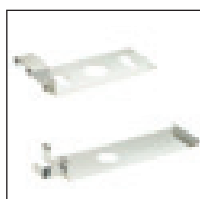

PCC/04

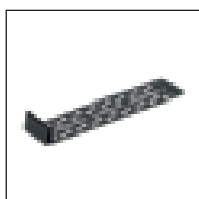

PCC/05

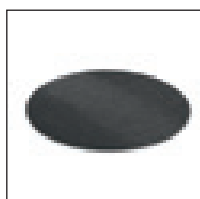

PPL/S



PPL/DLT

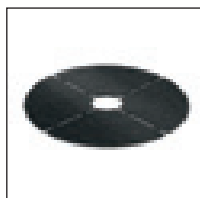

PPL/DLB

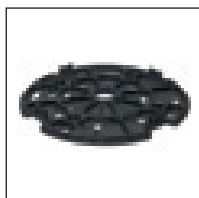

P1/10

### PP LEVEL DUO® AND PP LEVEL FIX ACCESSORIES

ART.			pack	
CR/N	adjustment key (for 4 mm joints)	19381	12 pcs	
	<i>euro/pc</i>	<b>31,34</b>		
PCC/01	perimetral clip (base + head)	19382	30 Kit	
	<i>euro/kit (euro/pack)</i>	<b>14,45 (433,50)</b>		
PCC/02	corner clip (base + head)	19383	4 Kit	
	<i>euro/kit (euro/pack)</i>	<b>33,80 (135,20)</b>		
PCC/03	wall clip	19384	50 pcs	
	<i>euro/kit (euro/pack)</i>	<b>3,55 (177,50)</b>		
PCC/04	clips for joists (base + head)	<b>NEW</b> 19386	30 Kit	
	<i>euro/kit (euro/pack)</i>	<b>15,17 (455,10)</b>		
PCC/05	wall clip in black polypropylene	<b>NEW</b> 19377	200 pcs	
	<i>euro/pc (euro/pack)</i>	<b>0,95 (190,00)</b>		
PPL/S	rubber disk diameter 21 cm x thickness 0,2 cm	<b>NEW</b> 19385	100 pcs	
	<i>euro/pc (euro/pack)</i>	<b>1,01 (101,00)</b>		
PPL/DLT	levelling disk for head diameter cm 12 x thickness 0,2 cm	<b>NEW</b> 19378	100 pcs	
	<i>euro/pc (euro/pack)</i>	<b>0,93 (93,00)</b>		
PPL/DLB	levelling disk for base diameter cm 21 x thickness 0,2 cm	<b>NEW</b> 19379	100 pcs	
	<i>euro/pc (euro/pack)</i>	<b>1,40 (140,00)</b>		

no partial packaging (except for CR/N)

### EXTENSION FOR PP LEVEL DUO® AND PP LEVEL FIX

ART.			pack	pallet
P1/10	extension element h 10 mm	<b>NEW</b> 19369	15 pcs	-
	<i>euro/pc (euro/pack)</i>	<b>1,20 (18,00)</b>		

no partial packaging



For a single piece, see sales conditions on page 288



Protec CPLV is a line of perimetral profiles in colour-coated aluminium, for the protection and finishing of the borders of outdoor raised floors, terraces or balconies. They are composed of a drilled base CPLB to be screwed to the supports, or, as an alternative, a cut base CPLB/2 for glued tiles, and a visible profile to be fixed with adhesive, available in 3 different heights according to the floor thickness. There are also special accessories for the creation of external corners and junctions.



CPLB + CPLV/60 ash grey RAL 7038 colour-coated aluminium

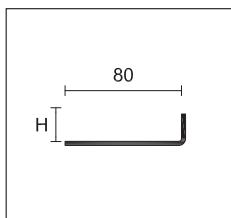
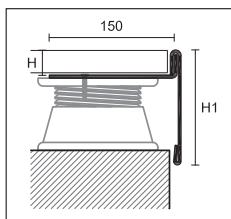

CPLB  
base for raised  
floors

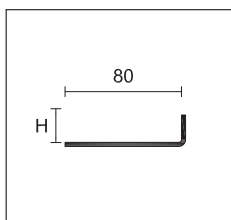

CPLB/2  
punched base for  
tiled floors

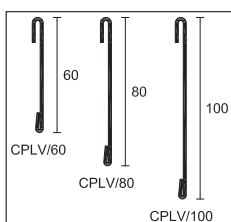

CPLV/

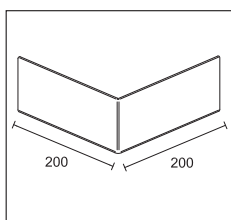

CPLV/ /E

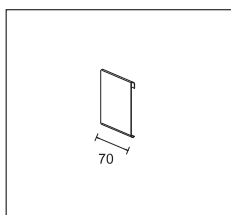

CPLV/ /G

**PROTEC**

length = 270 cm - pack 10 pcs

**H**

**BASE**

**ART. finishing**

**20**

**ALUMINIUM**

<b>CPLB</b>	natural aluminium		86900
	euro/m		<b>21,40</b>
<b>CPLB/2</b>	natural aluminium		86901
	euro/m		<b>11,64</b>

**NEW**

CPLB with draining holes available on request, extra euro/m 2,71  
CPLB and CPLB/2 in 15 and 25 mm height available on request  
possibility to choose noise-proof rubber PPL/GM, see page 253

**PROTEC**

length = 270 cm - pack 10 pcs

**H1**

**FRONT**

**ART. finishing**

**60**

**80**

**100**

**COLOUR-COATED ALUMINIUM**

<b>CPLV/</b>	ash grey RAL 7038		86902	86904	86906
	ancient grey		86903	86905	86907
	stone		86908	86909	86910
	greige		86911	86912	86913
	sand		86914	86915	86916
	beige		86917	86918	86919
	euro/m		<b>15,86</b>	<b>18,38</b>	<b>20,75</b>

**NEW**

white RAL 9003, dark brown RAL 8019, metal grey RAL 9006, aluminium grey RAL 9007, ash grey RAL 7038 embossed and rust with a minimum of 270 meters, on request, without surcharge. For other colours please contact our sales department.

**OUTSIDE CORNER A 90°**

pack 5 pcs

**H1**

**ART. finishing**

**60**

**80**

**100**

**COLOUR-COATED ALUMINIUM**

<b>CPLV/ /E</b>	ash grey RAL 7038		86920	86922	86924
	ancient grey		86921	86923	86925
	stone		86926	86927	86928
	greige		86929	86931	86933
	sand		86935	86936	86937
	beige		86938	86939	86940
	euro/pc		<b>26,95</b>	<b>26,95</b>	<b>26,95</b>

**NEW**

**JUNCTION**

width = 70 mm - pack 5 pcs

**H1**

**ART. finishing**

**60**

**80**

**100**

**COLOUR-COATED ALUMINIUM**

<b>CPLV/ /G</b>	ash grey RAL 7038		86930	86932	86934
	ancient grey		86941	86942	86943
	stone		86944	86945	86946
	greige		86947	86948	86949
	sand		86950	86951	86952
	beige		86953	86954	86955
	euro/pc		<b>5,46</b>	<b>5,46</b>	<b>5,46</b>

**NEW**

no partial packaging

For a single piece, see sales conditions on page 288





## accessories for installation

Levelling systems for  
tiles installation, spacers,  
adhesives, utensils, systems  
and accessories.

Protiler is a levelling system for the laying of ceramic and stone tiles. It is suitable for thicknesses from 3 to 20 mm and impedes the vertical movement between tiles during the adhesive grip phase. Specific pliers are available for the laying of floors and coverings for less effort and saving time.



*Protiler*



*disposable clips installation*



*tiles laying*

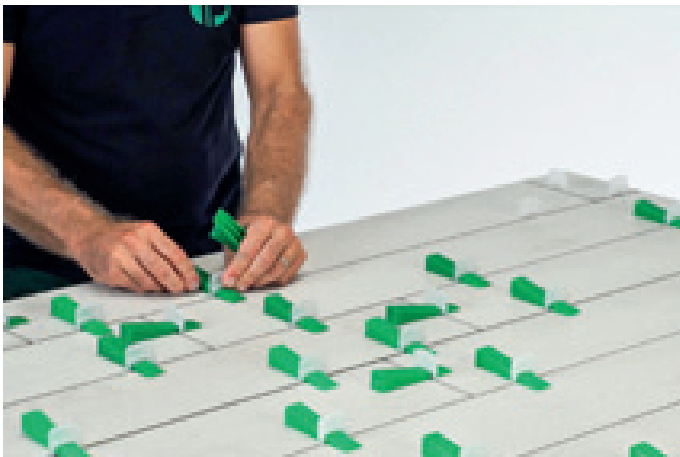

*levelling wedges insertion*



*wedges and clips removal*

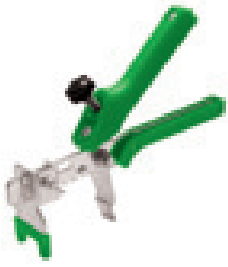

PTLN



PTWN



PTC  
PTC 1  
PTC1A  
PTC2  
PTC3

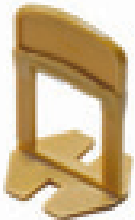

PTC4



PTS

**PROTILER**

pack 10 pcs

**ART.**

<b>PTLN</b>	adjustable traction pliers <i>euro/pc (euro/pack)</i>	18067 <b>20,50 (205,00)</b>
-------------	--	--------------------------------

no partial packaging

**LEVELLING WEDGES**

pack 14 bags with 100 pcs

**pallet**

**ART.**

<b>PTWN</b>	levelling wedges <i>euro/pc (euro/bag)</i>	18063 <b>0,095 (9,50)</b>	210 bags
-------------	---	------------------------------	----------

**NEW**

pack 1400 pcs

**pallet**

**ART.**

<b>PTWN/1400</b>	levelling wedges <i>euro/pc (euro/pack)</i>	18076 <b>0,086 (120,00)</b>	15 packs
------------------	--	--------------------------------	----------

no partial packaging

**DISPOSABLE CLIPS**

pack 12 bags with 250 pcs

**pallet**

**ART.**

<b>PTC</b>	clips for 0,5 mm grouts and tile thicknesses from 3 to 12 <i>euro/pc (euro/bag)</i>	18070 <b>0,0496 (12,40)</b>	180 bags
------------	--	--------------------------------	----------

<b>PTC1</b>	clips for 1 mm grouts and tile thicknesses from 3 to 12 <i>euro/pc (euro/bag)</i>	18071 <b>0,0496 (12,40)</b>	180 bags
-------------	--	--------------------------------	----------

<b>PTC1A</b>	clips for 1,5 mm grouts and tile thicknesses from 3 to 12 <i>euro/pc (euro/bag)</i>	18075 <b>0,0496 (12,40)</b>	180 bags
--------------	--	--------------------------------	----------

<b>PTC2</b>	clips for 2 mm grouts and tile thicknesses from 3 to 12 <i>euro/pc (euro/bag)</i>	18072 <b>0,0496 (12,40)</b>	180 bags
-------------	--	--------------------------------	----------

<b>PTC3</b>	clips for 3 mm grouts and tile thicknesses from 3 to 12 <i>euro/pc (euro/bag)</i>	18073 <b>0,0496 (12,40)</b>	180 bags
-------------	--	--------------------------------	----------

pack 60 bags with 50 pcs

**pallet**

**ART.**

<b>PTC4</b>	clips for 2 mm grouts and tile thicknesses from 12 to 20 mm <i>euro/pc (euro/bag)</i>	18074 <b>0,076 (3,80)</b>	600 bags
-------------	--	------------------------------	----------

**NEW**

pack 3000 pcs

**pallet**

**ART.**

<b>PTC/3000</b>	clips for 0,5 mm grouts and tile thicknesses from 3 to 12 <i>euro/pc (euro/pack)</i>	18077 <b>0,044 (132,00)</b>	15 packs
-----------------	---	--------------------------------	----------

<b>PTC1/3000</b>	clips for 1 mm grouts and tile thicknesses from 3 to 12 <i>euro/pc (euro/pack)</i>	18078 <b>0,044 (132,00)</b>	15 packs
------------------	---	--------------------------------	----------

<b>PTC1A/3000</b>	clips for 1,5 mm grouts and tile thicknesses from 3 to 12 <i>euro/pc (euro/pack)</i>	18079 <b>0,044 (132,00)</b>	15 packs
-------------------	---	--------------------------------	----------

<b>PTC2/3000</b>	clips for 2 mm grouts and tile thicknesses from 3 to 12 <i>euro/pc (euro/pack)</i>	18080 <b>0,044 (132,00)</b>	15 packs
------------------	---	--------------------------------	----------

<b>PTC3/3000</b>	clips for 3 mm grouts and tile thicknesses from 3 to 12 <i>euro/pc (euro/pack)</i>	18081 <b>0,044 (132,00)</b>	15 packs
------------------	---	--------------------------------	----------

no partial packaging

**NEW**

**BUCKET**

pack 15 pcs

**ART.**

**pack**

<b>PTS</b>	9.1 L bucket for accessories dim. cm 28x19x23 h. <i>euro/pc (euro/pack)</i>	18069 <b>8,07 (121,05)</b>	15 pcs
------------	--	-------------------------------	--------

no partial packaging

Fix Level is a screw levelling system for floors and coverings of different thickness, particularly suitable for large size tiles.

The cylinder incorporates a disk for the protection of the covering surface against scratches during the levelling phase.



Fix Level



FL/C

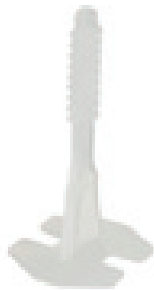

KL/1  
KL/1A  
KL/2  
KL/3

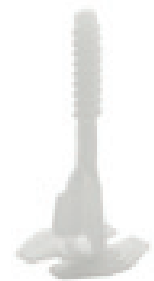

KL/T1  
KL/T2  
KL/T3

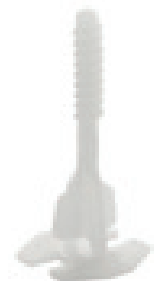

KL/X1  
KL/X2  
KL/X3



SFL

## CYLINDER WITH ANTI-SCRATCH DISK

pack 10 bags with 50 pcs

### ART.

<b>FL/C</b>	cylinder	18027
	<i>euro/pc (euro/bag)</i>	<b>0,5566 (27,83)</b>

no partial packaging

## DISPOSABLE SCREW SPACER

pack 30 bags with 100 pcs

### ART.

<b>KL/1</b>	screw for 1-mm grouts and tile thicknesses from 3 to 20 mm	18016
	<i>euro/pc (euro/bag)</i>	<b>0,1113 (11,13)</b>
<b>KL/1A</b>	screw for 1,5-mm grouts and tile thicknesses from 3 to 20 mm	18019
	<i>euro/pc (euro/bag)</i>	<b>0,1113 (11,13)</b>
<b>KL/2</b>	screw for 2-mm grouts and tile thicknesses from 3 to 20 mm	18017
	<i>euro/pc (euro/bag)</i>	<b>0,1113 (11,13)</b>
<b>KL/3</b>	screw for 3-mm grouts and tile thicknesses from 3 to 20 mm	18018
	<i>euro/pc (euro/bag)</i>	<b>0,1113 (11,13)</b>

no partial packaging

## NEW DISPOSABLE T-SCREW SPACER

pack 30 bags with 100 pcs

### ART.

<b>KL/T1</b>	T-screw for 1-mm grouts and tile thicknesses from 3 to 20 mm	18020
	<i>euro/pc (euro/bag)</i>	<b>0,1113 (11,13)</b>
<b>KL/T2</b>	T-screw for 2-mm grouts and tile thicknesses from 3 to 20 mm	18021
	<i>euro/pc (euro/bag)</i>	<b>0,1113 (11,13)</b>
<b>KL/T3</b>	T-screw for 3-mm grouts and tile thicknesses from 3 to 20 mm	18022
	<i>euro/pc (euro/bag)</i>	<b>0,1113 (11,13)</b>

no partial packaging

## NEW DISPOSABLE CROSS SCREW SPACER

pack 30 bags with 100 pcs

### ART.

<b>KL/X1</b>	cross screw for 1-mm grouts and tile thicknesses from 3 to 20 mm	18023
	<i>euro/pc (euro/bag)</i>	<b>0,1113 (11,13)</b>
<b>KL/X2</b>	cross screw for 2-mm grouts and tile thicknesses from 3 to 20 mm	18024
	<i>euro/pc (euro/bag)</i>	<b>0,1113 (11,13)</b>
<b>KL/X3</b>	cross screw for 3-mm grouts and tile thicknesses from 3 to 20 mm	18025
	<i>euro/pc (euro/bag)</i>	<b>0,1113 (11,13)</b>

no partial packaging

## UNSCREWER FOR FIX LEVEL

pack 50 pcs

### ART.

<b>SFL</b>	unscrew for Fix Level	18013
	<i>euro/pc (euro/pack)</i>	<b>0,7902 (39,51)</b>

no partial packaging

For a single piece, see sales conditions on page 288

Klic Level is a screw levelling system for floors and coverings of different thickness, particularly suitable for large size tiles. The cylinder incorporates a disk for the protection of the covering surface against scratches during the levelling phase, and a functional mechanism for a rapid insertion and expulsion of the disposable element.



Klic Level



KL/C

**CYLINDER WITH ANTI-SCRATCH DISK**

pack 10 bags with 50 pcs

**ART.**

<b>KL/C</b>	cylinder	18015
	<i>euro/pc (euro/bag)</i>	<b>0,7012 (35,06)</b>

no partial packaging

**DISPOSABLE SCREW SPACER**

pack 30 bags with 100 pcs

**ART.**

<b>KL/1</b>	screw for 1-mm grouts and tile thicknesses from 3 to 20 mm	18016
	<i>euro/pc (euro/bag)</i>	<b>0,1113 (11,13)</b>
<b>KL/1A</b>	screw for 1,5-mm grouts and tile thicknesses from 3 to 20 mm	18019
	<i>euro/pc (euro/bag)</i>	<b>0,1113 (11,13)</b>
<b>KL/2</b>	screw for 2-mm grouts and tile thicknesses from 3 to 20 mm	18017
	<i>euro/pc (euro/bag)</i>	<b>0,1113 (11,13)</b>
<b>KL/3</b>	screw for 3-mm grouts and tile thicknesses from 3 to 20 mm	18018
	<i>euro/pc (euro/bag)</i>	<b>0,1113 (11,13)</b>

no partial packaging

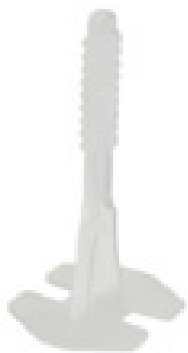

KL/1  
KL/1A  
KL/2  
KL/3

**CROSS SPACER FOR OUTDOOR USE**

pack 2 bags with 50 pcs

**ART.**

<b>DCE4</b>	cross spacer for outdoor tiles and 4-mm grouts	19076
	<i>euro/pc (euro/bag)</i>	<b>0,5076 (25,38)</b>

no partial packaging



DCE4

Spacer FIVE is a multi-thickness spacer for tiles: just one product for creating different grout spacing of 0,5 - 1 - 1,5 - 2 - 3 mm. The spacer can be used for laying both floors and wall coverings and complies with the regulation UNI 11493-1 since it has been designed to be easily removed and to be used more times. Five Spacer DF guarantees a perfect, quick and cheap laying.

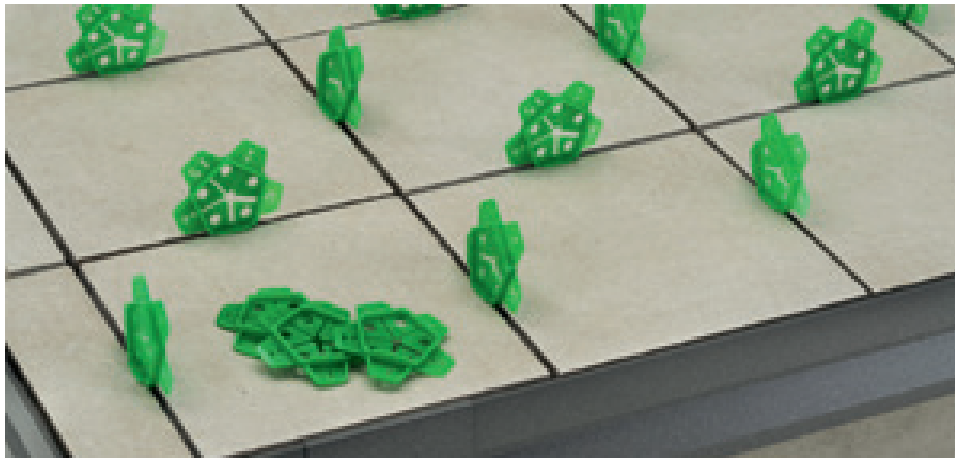

spacer FIVE



DF

## SPACER FIVE

pack 20 bags with 200 pcs

### ART.

**DF** spacer for tiles

19077

**euro/pc (euro/bag)**

**0,0717 (14,34)**

no partial packaging



Five bag

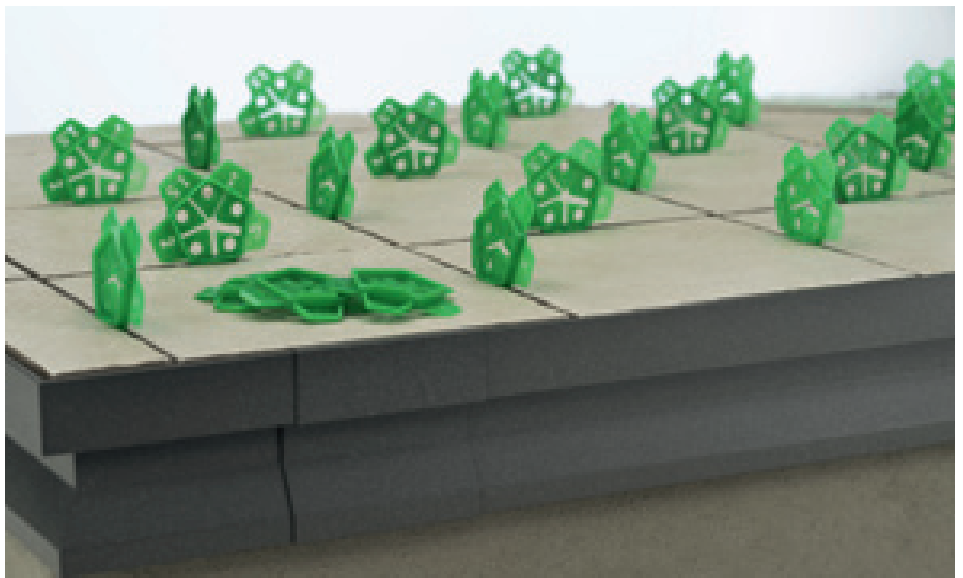

spacer FIVE



Plastic cross and T spacers used in the installation of floors and wall coverings for creating uniform and precise grout lines. They are available for thicknesses up to 10 mm and are suitable for both inside and outside spaces. Both spacers are compliant with UNI 11493-1 standard (methods for the correct installation of ceramic tiles).

Plastic wedges used for recovering small differences in height during tile installation.



Cross spacers

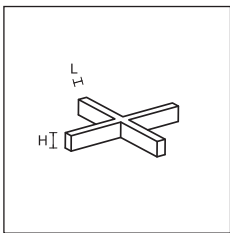

DC

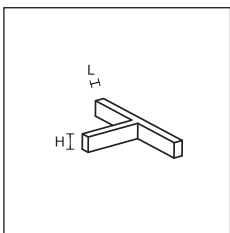

DT

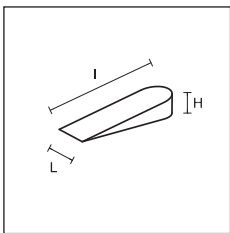

CN

**CROSS SPACERS**

LxH	box with 10 packs of 500 pcs					box with 20 packs of 250 pcs	
	1x5	2x5	3x5	4x5	5x5	7x6	10x8
ART.	DC1 solid	DC2 solid	DC3 drilled	DC4 drilled	DC5 drilled	DC7 drilled	DC10 drilled
	18992	19002	19008	19014	19020	19024	19030
<b>euro/pack</b>	<b>3,92</b>	<b>3,92</b>	<b>4,52</b>	<b>4,69</b>	<b>5,01</b>	<b>4,37</b>	<b>7,39</b>

no partial packaging

**T SPACERS**

LxH	box with 10 packs of 500 pcs					box with 20 packs of 250 pcs	
	1x5	2x5	3x5	4x5	5x5	7x6	10x8
ART.	DT1 solid	DT2 solid	DT3 drilled	DT4 drilled	DT5 drilled	DT7 drilled	DT10 drilled
	19038	19042	19048	19054	19060	19064	19070
<b>euro/pack</b>	<b>3,92</b>	<b>3,92</b>	<b>4,52</b>	<b>4,69</b>	<b>5,01</b>	<b>4,37</b>	<b>7,39</b>

no partial packaging

**WEDGES**

pack	box with 20 packs of 250 pcs	box with 10 packs of 500 pcs
LxIxH	9x28x5	9x28x5
ART.	CN28	CN28
	19080	19082
<b>euro/pack</b>	<b>2,54</b>	<b>4,50</b>

no partial packaging



T Spacers



Wedges

For a single piece, see sales conditions on page 288



skirting board adhesive

**MS POLYMER-BASED ADHESIVE FOR SKIRTING BOARDS**

pack 24 pcs - quantity 290 ml

<b>PP/96</b>	78301
<i>euro/pc</i>	<b>18,81</b>

output 10/15 m for cartridge



polishing paste

**MAGNETIC KIT**

box with 10 blisters

<b>K10</b>	00410
<i>euro/blister</i>	<b>12,59</b>

**POLISHING PASTE FOR METAL PROFILE CLEANING**

pack 20 pcs - quantity 150 ml

<b>POLISHING PASTE</b>	30018
<i>euro/pc</i>	<b>31,85</b>



doubled sided adhesive tapes

**DOUBLED SIDED ADHESIVE TAPES**

	<b>POLYPROPYLENE</b>	<b>COTTON CLOTH</b>
pack	24	24
LxL cm	5x2500	5x2500
ART.	<b>D/4461/K</b>	<b>D/4471/K</b>
	30004	30014
<i>euro/pc</i>	<b>8,04</b>	<b>11,78</b>



**SCREWS**

	<b>FLAT HEAD</b>				<b>ROUND HEAD</b>	
box - 1000 pcs						
finishing	nickel-plated	brass plated	bronze plated	brass plated	nickel-plated	brass plated
LxL mm	<b>3X25</b>	<b>3X25</b>	<b>3X25</b>	<b>3X25</b>	<b>3,5X25</b>	<b>3,5X25</b>
ART.	<b>SS/5</b>	<b>SS/5</b>	<b>SS/5</b>	<b>RR/5</b>	<b>SS/4</b>	<b>SS/4</b>
	68800	68801	68802	68803	68804	68805
<i>euro/box</i>	<b>85,02</b>	<b>85,02</b>	<b>85,02</b>	<b>190,72</b>	<b>85,02</b>	<b>85,02</b>

Proflex machine is a machine designed and built to model the profiles with curvilinear shape of the proflex line produced by Profilpas. The machine contains a proper kit and more kits are available in case you need to bend the PLAF or Metal Line 90.

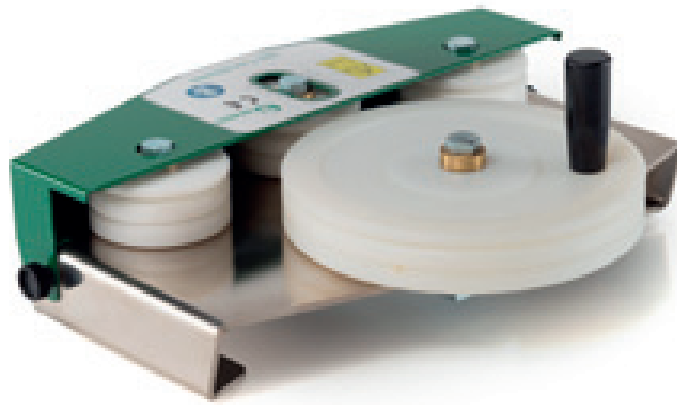

PROFLEX MACHINE - hand machine to bend proflex line profiles

**PROFLEX MACHINE**

ART.	description	
<b>proflex</b>	hand machine to bend profiles inside and outside	30022
	<i>euro/pc</i>	<b>724,36</b>
<b>30046</b>	wheels kit with perforated side on the outside for PLAF	30046
	<i>euro/pc</i>	<b>316,90</b>
<b>30049</b>	wheels kit with perforated side on the inside for PLAF	30049
	<i>euro/pc</i>	<b>342,78</b>
<b>30052</b>	wheels kit for metal line flex 90/	30052
	<i>euro/pc</i>	<b>858,41</b>



kit 30046



kit 30049



kit 30052

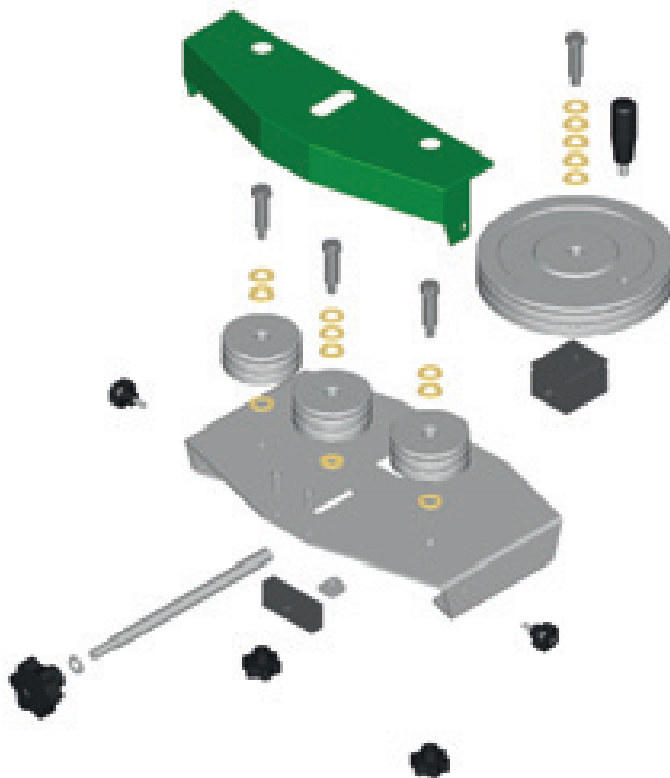











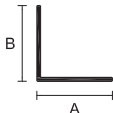
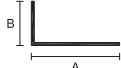

## DIY profiles

A wide range of DIY profiles in aluminium, stainless steel and brass, available in many measures. Suitable to solve professional and bricolage works.



## profiles in anodised aluminium

		with barcode label			
		length m. 1		length m. 2	
	measures	silver	euro/pc	silver	euro/pc
flat 	12x2	10100	2,04	10104	3,73
	15x2	10108	2,35	10112	4,40
	20x2	10116	2,64	10120	4,92
	25x2	10124	2,94	10128	5,59
	30x2	10132	3,36	10136	6,38
	40x2	-	-	-	-
	50x2	-	-	-	-
	60x2	-	-	-	-
corner 	10x10x1	10140	2,04	10144	3,73
	15x15x1	10148	2,23	10152	4,16
	20x20x1*	10156	2,68	10160	5,02
	25x25x1*	10164	2,94	10168	5,59
	30x30x1*	10172	3,24	10176	6,13
	30x30x1,5	-	-	09020	8,57
	40x40x1,5	10380	5,70	10384	11,08
	40x40x2	-	-	-	-
	50x50x2	-	-	-	-
corner L 	15x10x1	10180	2,06	10184	3,78
	20x10x1	10188	2,18	10192	4,04
	30x15x1	10196	2,73	10200	5,13
U profile 	8x8x1	10204	1,92	10208	3,49
	10x10x1	10212	2,18	10216	4,04
	10x15x1	10220	2,64	10224	4,92
	12x12x1	-	-	10218	4,92
double U profile 	16x7x1	-	-	10232	4,53
	16x12x1	10236	3,00	10240	5,70
	20x10x1	-	-	10248	5,70
	20x18x1	10252	3,87	10256	7,41
edge trim 	18x1	10260	2,25	10264	4,17
	22x1	10268	2,35	10272	4,40
	25x1	10276	2,42	10280	4,53
round tube 	8x1	09032	2,10	09036	3,89
	10x1	09040	2,29	09044	4,26
	12x1	09048	2,55	09052	4,75
	15x1	10284	2,73	10288	5,13
	18x1	10292	3,06	10296	5,82
	20x1	10300	3,38	10304	6,43
	25x1,5	-	-	09060	10,42
square tube 	10x10x1	10308	2,68	10312	5,02
	15x15x1	10316	3,47	10320	6,58
	20x20x1	10324	4,23	10328	8,15
rectangular tube 	20x10x1	10332	3,47	10336	6,58
	30x15x1	10340	4,34	10344	8,36
T profile 	15x15x1,5	10348	2,78	10352	5,24
	25x25x1,5	10356	3,87	10360	7,40
round bar 	Ø 6	-	-	09084	4,53
	Ø 8	10364	3,17	10368	6,02
	Ø 10	-	-	09092	8,37
square bar 	8x8	10372	3,74	10376	7,19
	10x10	-	-	10394	10,31

Articles no partial packaging. Pack. 10 pcs per item - Minimum order : 100 assorted pcs DIY range.







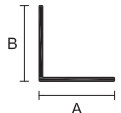
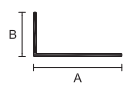
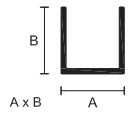

\* items available also 3 m long without barcode pag 271

For a single piece, see sales conditions on page 288

EAN 13 = the first group product code

example code 10395 = 8010937 10395

## profiles in anodised aluminium

		without barcode label			
		length m. 2		length m. 3	
		silver	euro/pc	silver	euro/pc
flat 	measures				
	12x2	510104	3,43	-	-
	15x2	510112	4,12	-	-
	20x2	510120	4,62	-	-
	25x2	510128	5,29	-	-
	30x2	510136	6,08	-	-
	40x2	510095	8,58	510096	12,85
	50x2	510099	10,84	510097	16,25
corner 	10x10x1	510144	3,43	-	-
	15x15x1	510152	3,86	-	-
	20x20x1	510160	4,73	510158	7,08
	25x25x1	510168	5,29	510166	7,93
	30x30x1	510176	5,82	510174	8,73
	30x30x1,5	509020	8,25	-	-
	40x40x1,5	510384	10,78	-	-
	40x40x2	510381	16,13	510383	24,18
	50x50x2	510382	19,41	510387	29,14
	corner L 	15x10x1	510184	3,49	
20x10x1		510192	3,73		
30x15x1		510200	4,83		
U profile 	8x8x1	510208	3,17		
	10x10x1	510216	3,73		
	10x15x1	510224	4,62		
	12x12x1	510218	4,62		
double U profile 	16x7x1	510232	4,21		
	16x12x1	510240	5,41		
	20x10x1	510248	5,41		
	20x18x1	510256	7,11		
edge trim 	18x1	510264	3,87		
	22x1	510272	4,12		
	25x1	510280	4,21		
round tube 	8x1	509036	3,56		
	10x1	509044	3,98		
	12x1	509052	4,43		
	15x1	510288	4,83		
	18x1	510296	5,50		
	20x1	510304	6,13		
square tube 	25x1,5	509060	10,11		
	10x10x1	510312	4,73		
	15x15x1	510320	6,27		
rectangular tube 	20x20x1	510328	7,86		
	20x10x1	510336	6,27		
T profile 	30x15x1	510344	8,03		
	15x15x1,5	510352	4,92		
round bar 	25x25x1,5	510360	7,10		
	Ø 6	509084	4,21		
	Ø 8	510368	5,71		
square bar 	Ø 10	509092	8,05		
	8x8	510376	6,88		
	10x10	510394	10,01		

Articles no partial packaging. Pack. 10 pcs per item - Minimum order : 100 assorted pcs DIY range.







EAN 13 = the first group product code

example code 10395 = 8010937 10395

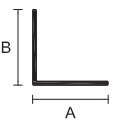
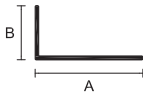
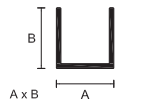
For a single piece, see sales conditions on page 288

## profiles in anodised and colour-coated aluminium

with barcode label  
length m. 2

	measures	gold anodised	titanium anodised	colour-coated white RAL 9003	euro/pc
piatto 	12x2	10105	-	-	3,78
	15x2	10113	-	11612	4,47
	20x2	10121	10470	11620	4,99
	30x2	10137	-	11636	6,45
angolare 	10x10x1	10145	10452	11644	3,78
	15x15x1	10153	10454	11652	4,21
	20x20x1	10161	10456	11660	5,09
	25x25x1	10169	10458	11668	5,66
	30x30x1	10177	-	11676	6,18
	40x40x1,5	10385	-	11684	11,22
angolare L 	15x10x1	10185	10462	11692	3,86
	20x10x1	10193	10464	11700	4,10
	30x15x1	10201	10466	11708	5,22
canalino a U 	8x8x1	10209	-	-	3,52
	10x10x1	-	-	11724	4,10
	10x15x1	10225	-	-	4,99
canalino a doppia U 	20x18x1	-	-	11764	7,50
unghietta 	18x1	10265	-	11772	4,22
	22x1	10273	-	-	4,47
	25x1	10281	-	-	4,59
tubo rotondo 	10x1	09045	-	-	4,33
	15x1	-	-	11796	5,22
	18x1	10297	-	-	5,90
	20x1	10305	-	-	6,52
tubo quadro 	10x10x1	-	-	11820	5,09
tubo rettangolare 	20x10x1	10337	-	11844	6,66
profilo a T 	15x15x1,5	-	-	11860	5,30
	25x25x1,5	-	-	11868	7,49

Articles no partial packaging. Pack. 10 pcs for gold items, 5 pcs for titanium items

Minimum order: 100 assorted pcs DIY range.



EAN 13 = the first group product code

example code 10395 = 8010937 10395

For a single piece, see sales conditions on page 288

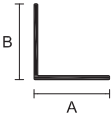
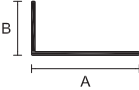
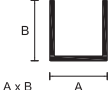

## profiles in bright polished silver aluminium

		with barcode label			
		length m. 1		length m. 2	
	measures	silver	euro/pc	silver	euro/pc
flat 	15x2	-	-	10115	6,97
	20x2	-	-	10123	7,64
	25x2	-	-	10131	8,56
corner 	10x10x1	10143	3,26	10147	6,18
	15x15x1	10151	3,51	10155	6,66
	20x20x1	10159	4,08	10163	7,80
	25x25x1	-	-	10171	8,64
	30x30x1	-	-	10179	9,51
corner L 	15x10x1	-	-	10186	6,33
	20x10x1	-	-	10195	6,66
	30x15x1	-	-	10203	8,13
U profile 	10x10x1	-	-	10219	6,39
	10x15x1	-	-	10227	7,75
	12x12x1	-	-	10211	8,00
edge trim 	18x1	-	-	10267	6,76
T profile 	15x15x1,5	10351	4,28	10355	8,24

Pack. 5 pcs per article

Minimum order: 100 assorted pcs DIY range.

For a single piece, see sales conditions on page 288

## polished brass and stainless steel corners

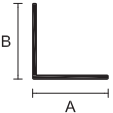
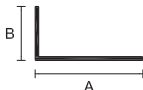
		with barcode label			
		length m. 2			
corner	measures	polished brass	euro/pc	stainless steel	euro/pc
	15x15x1	10002	30,84	10050	12,17
	20x20x1	10006	39,35	10054	15,32
	25x25x1	-	-	10058	18,59
	30x30x1	10014	60,36	10062	22,58
	40x40x1	-	-	10070	29,32
	15x10x1	10030	25,90	-	-
	20x10x1	10034	30,84	10082	12,17
	30x10x1	-	-	10086	15,33

Articles no partial packaging.

Pack. 5 pcs per article - Minimum order: 100 assorted pcs DIY range.

EAN 13 = the first group product code

example code 10094 = 8010937 10094

## curtain counterweights in silver anodised aluminium with rounded edges

		length m. 1		length m. 2		length m. 4	
	measures	cod.	euro/pc	cod.	euro/pc	cod.	euro/pc
	30x4 boxes pcs 10	10604	6,38	10605	12,75	10606	25,25
	40x4 boxes pcs 10	10608	8,63	10609	17,22	-	-

Articles no partial packaging.

EAN 13 = the first group product code

example code 10824 = 8010937 10824

For a single piece, see sales conditions on page 288

## silver anodised aluminium profiles for structures

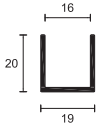
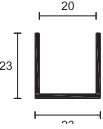
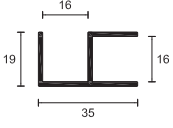
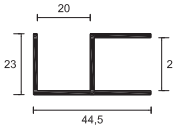
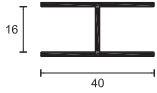
				with barcode label				
				length m. 2		length m. 3		
		measures thickness		cod.	euro/pc	cod.	euro/pc	
U profile		for panels frame thickness up to 16 mm Packaging 6 pcs per item.	16	1,5	10500	11,70	10504	17,39
U profile		for panels frame thickness up to 20 mm Packaging 6 pcs per item.	20	1,5	10532	13,92	10536	20,71
double U profile		for 90° corners between panel boards thickness up to 16 mm Packaging 6 pcs per item.	16	1,5	-	-	10512	25,82
double U profile		for 90° corners between panel boards thickness up to 20 mm Packaging 6 pcs per item.	20	1,5	-	-	10544	31,23
H profile		for connection of panels thickness up to 16 mm Packaging 6 pcs per item.	16	1,5	-	-	10520	28,34



Design is our best profile.

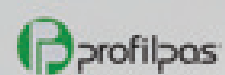

Design is our best profile.





Design is our best profile.

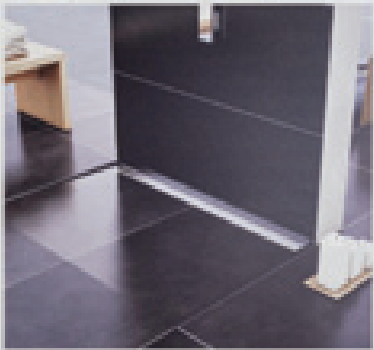

Design is our best profile.



## merchandising for the point of sale

A series of tools dedicated to the showroom: modular expositive pieces of furniture, counter display boxes, sampleboards, sample boxes, cylinders etc for creating suitable areas for every need of space and products.



Profilpas concept store: a modular display system composed of panels that can be used singularly or combined together. For each panel, there is the possibility to choose the display units according to the products treated.



PANEL 1 terrace picture DIM. CM 90X220 H.	02036	€ 219,90
PANEL 2 living room picture DIM. CM 90X220 H.	02037	€ 219,90
PANEL 3 bathroom picture DIM. CM 90X220 H.	02038	€ 219,90
PANEL 4 staircase picture DIM. CM 90X220 H.	02039	€ 219,90

SELF-SUPPORTING BASE FOR PANELS	02040	€ 142,29
---------------------------------	-------	----------

DISPLAY UNIT 1 - CPGV+CPQV+WPSTOP 3	02041	€ 129,35
DISPLAY UNIT 2 - CPNV+CPCV/30	02042	€ 90,55
DISPLAY UNIT 3 - SNG+SIR+SIG+SIS+SP+76	02043	€ 219,90
DISPLAY UNIT 4 - GIN+ILN+ZQIN	02044	€ 271,64
DISPLAY UNIT 5 - ZQVN Trend Color Stone	02045	€ 271,64
DISPLAY UNIT 6 - SLIM DRAIN+GLASS PROFILE	02046	€ 620,27
DISPLAY UNIT 7 - SMART DRAIN	02047	€ 530,33
DISPLAY UNIT 8 - THIN DRAIN	02048	€ 478,60
DISPLAY UNIT 9 - case for sample boards (without sample boards)	02049	€ 84,08
DISPLAY UNIT 10 - 8605+8608	02055	€ 64,68
DISPLAY UNIT 11 - PP LEVEL DUO	02064	€ 152,46
DISPLAY UNIT 7/a - shelf only	02056	€ 45,27



self-supporting base for panels

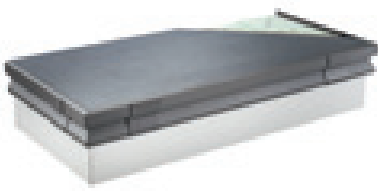

display unit 1  
CPGV - WPstop 3

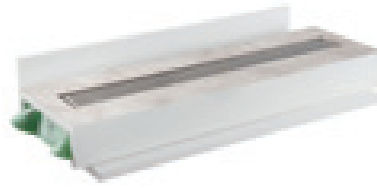

display unit 7  
Smart Drain

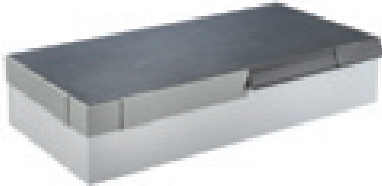

display unit 2  
CPNV - CPCV/30



display unit 8  
Thin Drain

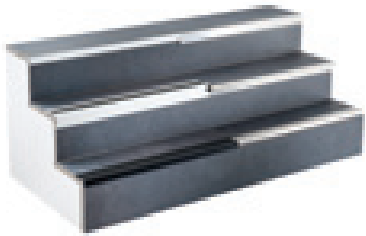

display unit 3  
SNG + SIR + SGI + SIS +  
SP - 76



display unit 9  
case for sample boards



display unit 4  
GIN + ILN + ZQIN

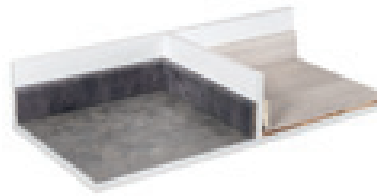

display unit 10  
8605 - 8608

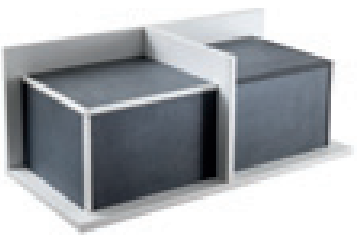

display unit 5  
ZQVN Trend Color Stone



display unit 11  
PP Level Duo®

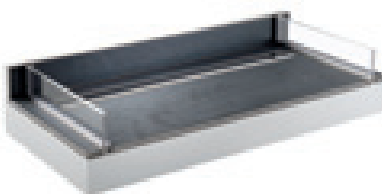

display unit 6  
Slim Drain + Glass Profile



display unit 7/A  
shelf only



black totem for sample boards dim. cm 55x55x200 h	02034	€ 316,65
white totem for sample boards dim. cm 55x55x200 h.	02035	€ 316,65

Exhibition panels divided for different application categories. They are also suitable for inclusion in the drawer corner shop.

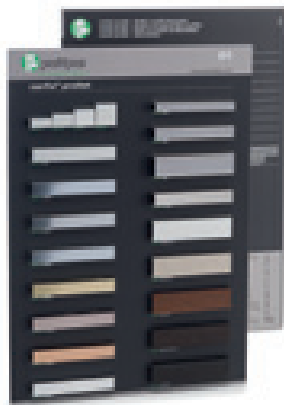

sampleboard 1	PROLIST decorative listellos and profiles	02015	€ 35,26
sampleboard 2	external corners profiles PROTRIM	02016	€ 35,26
sampleboard 3	external corners profiles PROANGLE Q	02017	€ 35,26
sampleboard 4	external corners profiles PROCORNER internal corners profiles PROROUND	02018	€ 35,26
sampleboard 5	profiles for small gaps	02019	€ 35,26
sampleboard 6	profiles for floors of same height	02020	€ 35,26
sampleboard 7	profiles for floors of different height	02021	€ 35,26
sampleboard 8	profiles for LVT floors	02022	€ 35,26
sampleboard 9	Expansion joints PROJOINT	02023	€ 35,26
sampleboard 10	profiles for balconies and terraces PROTEC	02024	€ 35,26
sampleboard 11	stair nosing profiles	02025	€ 35,26
<b>NEW</b> sampleboard 12/A	Unisystem plus	02065	€ 35,26
<b>NEW</b> sampleboard 12/B	prestowood - pvc line	02066	€ 35,26
sampleboard 13/A	METAL LINE 89-90-790	02057	€ 35,26
sampleboard 13/B	METAL LINE 87-88-92-93-95-97-98-100	02058	€ 35,26
<b>NEW</b> sampleboard 14	Trend Color	02028	€ 35,26
<b>NEW</b> sampleboard 17	PVC Line skirting boards	02078	€ 35,26



<b>NEW</b> black counter display Trend Color Proangle Q	00193	€ 64,00
<b>NEW</b> black counter display Trend Color Proangle	00219	€ 64,00
black counter display Proangle Q	00166	€ 34,97

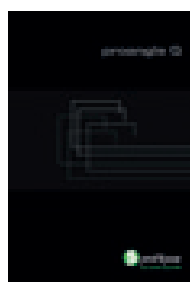







sample box PROANGLE Q ITA/GB	00184	€/pz 20,19
sample box PROANGLE Q FR/TED	00188	€/pz 20,19
sample box PROANGLE Q SPA/POR	00189	€/pz 20,19

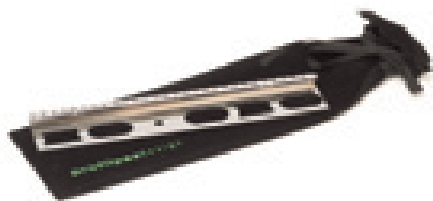



cylinder wall profiles	00103	€ 15,67
cylinder floor profiles	00104	€ 15,67
cylinder small gaps profiles	00114	€ 15,67
cylinder proangle Q	00115	€ 15,67
cylinder unisystem	00080	€ 15,67
cylinder proline	00127	€ 15,67
cylinder LVT	00142	€ 15,67
cylinder proligh	00143	€ 15,67



	sample DJKC/10	00134	€ 13,43
	sample DJKC/10	00135	€ 21,67
	sample UKC/10	00136	€ 25,90
	sample DJKGC/10	00137	€ 41,31
	sample UKGC/10	00138	€ 46,06



<b>NEW</b>	brochure profiles and skirting boards for wood and laminate IT/GB	00285	€ 1,20
	brochure profiles and skirting boards for wood and laminate FR/DE	00286	€ 1,20
	brochure profiles and skirting boards for wood and laminate ES/PT	00287	€ 1,20
	brochure profiles and skirting boards for wood and laminate CZ/PL	00290	€ 1,20



<b>NEW</b>	brochure profiles for balconies and terraces IT/GB	00279	€ 1,20
	brochure profiles for balconies and terraces FR/DE	00280	€ 1,20
	brochure profiles for balconies and terraces ES/PT	00281	€ 1,20
	brochure profiles for balconies and terraces CZ/PL	00288	€ 1,20



profiles for balconies and terraces bunch	00117	€ 19,74
---	-------	---------

sampleboard 10 profiles for balconies and terraces PROTEC	02024	€ 35,26
---	-------	---------

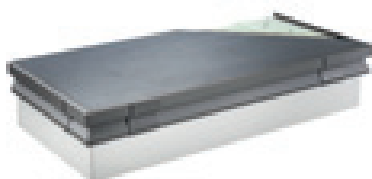

display unit 1 CPGV+CPQV+WPSTOP 3	02041	€ 129,35
display unit 2 CPNV - CPCV/30	02042	€ 90,55



<b>NEW</b>	counter display pp drain aqua - classic cover dim. cm 70x32x30 H. (cover not included, to be ordered separately)	02072	€ 231,00
	counter display pp drain aqua - flat cover dim. cm 70x32x30 H. (cover not included, to be ordered separately)	02073	€ 231,00
	counter display pp drain aqua - design cover dim. cm 70x32x30 H. (cover not included, to be ordered separately)	02074	€ 231,00

<b>NEW</b>	counter display pp drain aqua - classic cover dim. cm 70x32x30 H. (linear drain and cover not included, to be ordered separately)	02075	€ 63,00
	counter display pp drain aqua - flat cover dim. cm 70x32x30 H. (linear drain and cover not included, to be ordered separately)	02076	€ 63,00
	counter display pp drain aqua - design cover dim. cm 70x32x30 H. (linear drain and cover not included, to be ordered separately)	02077	€ 63,00



<b>NEW</b>	pp drain aqua finishes sampleboard	00164	€ 46,20
------------	------------------------------------	-------	---------

<b>NEW</b>	brochure pp drain aqua IT/GB	00295	€ 1,27
	brochure pp drain aqua FR/DE	00296	€ 1,27
	brochure pp drain aqua ES/PT	00297	€ 1,27
	brochure pp drain aqua CZ/PL	00298	€ 1,27



<b>NEW</b>	catalogue/price list linear shower drains and systems for bathrooms 2022 IT	00360	€ 1,40
	catalogue/price list linear shower drains and systems for bathrooms 2022 GB	00361	€ 1,40
	catalogue/price list linear shower drains and systems for bathrooms 2022 FR	00362	€ 1,40
	catalogue/price list linear shower drains and systems for bathrooms 2022 DE	00363	€ 1,40
	catalogue/price list linear shower drains and systems for bathrooms 2022 ES	00364	€ 1,40
	catalogue/price list linear shower drains and systems for bathrooms 2022 PT	00365	€ 1,40
	catalogue/price list linear shower drains and systems for bathrooms 2022 CZ	00366	€ 1,40
	catalogue/price list linear shower drains and systems for bathrooms 2022 PL	00367	€ 1,40
	catalogue/price list linear shower drains and systems for bathrooms 2022 RU	00368	€ 1,40



<b>NEW</b>	sample of glass profile in satin stainless steel	00072	€ 1,91
	sample of glass profile in matt black colour-coated stainless steel	00078	€ 2,92

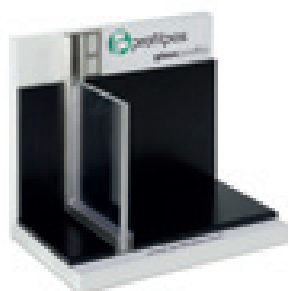

<b>NEW</b>	counter display glass profile - satin stainless steel	00311	€ 63,00
	counter display glass profile - matt black colour-coated stainless steel	00315	€ 63,00



leaflet WPSTOP IT/GB	00176	€/pz	0,21
sample box WPSTOP ITA	00182	€/pz	10,70
sample box WPSTOP GB	00183	€/pz	10,70
sample box WPSTOP TED	00185	€/pz	10,70
sample box WPSTOP SPA	00186	€/pz	10,70
sample box WPSTOP POR	00187	€/pz	10,70

sample box PP Level DUO	00038	€	9,15
-------------------------	-------	---	------

<b>NEW</b> sample of PP Level DUO double joist system	00047	€/pz	15,50
---	-------	------	-------

brochure PP Level DUO IT/GB	00042	€	1,27
brochure PP Level DUO FR/DE	00043	€	1,27
brochure PP Level DUO ES/PT	00044	€	1,27
brochure PP Level DUO PL/CZ	00045	€	1,27
brochure PP Level DUO RU/HR	00046	€	1,27

leaflet PP Level DUO IT/GB	00260	€	0,21
leaflet PP Level DUO FR/DE	00261	€	0,21
leaflet PP Level DUO ES/PT	00262	€	0,21
leaflet PP Level DUO PL/CZ	00263	€	0,21
leaflet PP Level DUO RU/HR	00264	€	0,21

<b>NEW</b> PROTILER - sample kit 20 PTWN + 20 PTC2	00207	€	1,80
KLIC LEVEL - sample kit 4 pcs.	00105	€	1,86
FIX LEVEL - sample kit 4 pcs.	00089	€	1,86
FIVE - sample kit 4 pcs.	00083	€	1,86

<b>NEW</b> Protiler floor-standing display ESPT	11595	€	68,64
---	-------	---	-------

<b>NEW</b> brochure Protiler IT/GB	00291	€	0,30
brochure Protiler FR/DE	00292	€	0,30
brochure Protiler ES/PT	00293	€	0,30
brochure Protiler CZ/PL	00294	€	0,30



PDS bunch

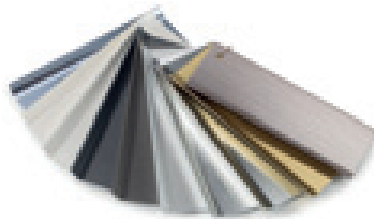

metal line bunch



bunch 8605/8608



pvc skirting board bunch



bunch ZQP



bunch RPA



profiles for balconies bunch



bunch RE



bunch REC



bunch RECO



DIY bunch



sandblast stainless steel bunch



chromium-plated brass bunch



antibacterial profiles bunch

PDS bunch	00020	€ 9,91
8605/8608 bunch	00126	€ 3,55
metal line bunch	00119	€ 16,94
PVC skirting board bunch	00085	€ 6,36
profiles for balconies bunch	00117	€ 19,74
ZQP bunch	00027	€ 6,36
RPA bunch	00050	€ 6,36
RE bunch	00011	€ 6,36
REC bunch	00049	€ 6,36
RECO bunch	00133	€ 6,36
DIY bunch	00128	€ 12,71
chromium-plated brass bunch	00130	€ 15,52
sandblast stainless steel profiles bunch	00132	€ 3,55
bunch pvc stair nosing	00084	€ 6,36
bunch antibacterial profiles	00147	€ 3,55
bunch PDS xl	00140	€ 40,30
bunch black & white	00033	€ 6,72
<b>NEW</b> bunch ZQVN Trend Color	00021	€ 18,20
<b>NEW</b> bunch ZV Trend Color	00023	€ 18,20
bunch IPV Trend Color Stone	00037	€ 12,71
<b>NEW</b> bunch Prestowood	00039	€ 12,71



## MATERIALS AND CHARACTERISTICS

The following information summarize the main characteristics of the materials. Further information are available upon request of the product specifications.

### NATURAL BRASS

Alloy CW624N UNI EN 12167 The profiles are produced by extrusion. They have a good resistance to chemical agents and mechanical stresses. On the visible parts the brass naturally oxidizes that creates a superficial glaze. The brass, when exposed to corrosive agents or high humidity, is subject to phenomena of high oxidation and can present superficial spots. Where necessary, it can be restored to its original state by using abrasives or specific polishing products.

### POLISHED BRASS

Alloy CW624N UNI EN 12167 The profiles are produced by extrusion and then mechanically polished. The visible surface must be protected from scratches and frictions. The resistance to chemical agents and mechanical stresses is good. On the visible parts the brass naturally oxidizes that creates a superficial glaze. The brass, when exposed to corrosive agents or high humidity, is subject to phenomena of high oxidation and can present superficial spots. Where necessary, it can be restored to its original state by using abrasives or specific polishing products.

### CHROMIUM - PLATED BRASS

Alloy CW624N UNI EN 12167 The profiles are produced by extrusion and then chromed. They are resistant to ultraviolet rays, weathering and chemical agents. They are not suitable for applications in floors with intense mechanical stresses.

### NATURAL ALUMINIUM

Alloy of Al-Mg-Si thermally treated in conditions T6 (6060 T6) The profiles are produced by extrusion and guarantee a fair resistance to atmospheric and chemical agents. The cement and its derivatives produce, if wet, alkaline substances that, acting on the surface, can corrode the metal (formation of hydroxide of aluminium). For that reason, the visible surface of the profile must be immediately cleaned from cement, glue and other materials used for joints.

### ANODISED ALUMINIUM

Alloy of Al-Mg-Si thermally treated in conditions T6 (6060 T6) The profiles are produced by extrusion and then anodised. They have a good resistance to atmospheric and chemical agents. The cement and its derivatives produce, if wet, alkaline substances that, acting on the surface, can corrode the metal (formation of hydroxide of aluminium). For that reason, the visible surface of the profile must be immediately and gently cleaned from cement, glue and other materials used for joints. Wear and pedestrian traffic could damage the surface (in cases of profiles laid on the floor) and remove the original anodised finish.

### POLISHED ALUMINIUM

Alloy of Al-Mg-Si thermally treated in conditions T6 (6060 T6) The profiles are produced by extrusion and then mechanically treated and processed. They guarantee a fair resistance to atmospheric and chemical agents. The cement and its derivatives produce, if wet, alkaline substances that, acting on the surface, can corrode the metal (formation of hydroxide of aluminium). For that reason, the visible surface of the profile must be immediately and gently cleaned from cement, glue and other materials used for joints. Polished aluminium profiles are not suitable for floor applications.

### COLOUR - COATED ALUMINIUM

Alloy of Al-Mg-Si thermally treated in conditions T6 (6060 T6) The profiles are made by extrusion and then coated with a thickness of  $\geq 80 \mu\text{m}$ . They have

a fair resistance to atmospheric and chemical agents while they do not have a good resistance to mechanical stresses that would damage the surface enamel; therefore they are not recommended for floor applications. For that reason, the visible surface of the profile must be immediately and gently cleaned from cement, glue and other materials used for joints.

### ALCROM® PLUS FOILED ALUMINIUM

Alloy of Al-Mg-Si thermally treated in conditions T6 (6060 T6) The profiles are produced by extrusion in natural alloy. The wood decoration is obtained by foiling the aluminium profiles with a special film Alcrom® Plus, resistant to wear, perfectly reproducing grains and colours of wood.

### STAINLESS STEEL - AISI 430 - DIN 1.4016

This kind of stainless steel has a moderate resistance to corrosive agents. We recommend its use exclusively for indoor use.

### STAINLESS STEEL - AISI 304 - DIN 1.4301 V2A

It is extremely resistant to most chemical and atmospheric agents, lime, mortar, tile glue and common cleaning products. It is recommended for outdoor use, food processing industry, hospitals, etc.

### STAINLESS STEEL - AISI 316 – DIN 1.4404 V4A

It is extremely resistant to most chemical and atmospheric agents, lime, mortar, tile glue and common cleaning products. Moreover it has a good resistance to chlorine and salt. Particularly indicated in extreme conditions of use.

### LAYING - WARNINGS:

even stainless steel can be damaged if not treated with proper precautions during the laying stages. In particular, pay attention to: keeping the profiles protected inside their individual packaging up until the installation. (this precaution allows to avoid the contamination with other ferrous materials during the transport). Avoiding the direct contact with cleaning products for cotto tiles and marble, decalcifying agents and cleansers containing chlorine and its compounds. Pay attention to the gases of hydrochloric acid which may develop during the cleansing of special floors. After the laying, proceed immediately with an accurate cleaning of the surface with plenty of water and the consequent drying.

### MAINTENANCE:

the frequent cleaning is essential to preserve the beauty of stainless steel profiles surfaces. Pay close attention to the treatment of the profiles' surface during the installation. Immediately after installation, clean by rinsing the surfaces accurately. Avoid the use of abrasive products that may scratch the profile. Do not use cleansers containing chlorine and its compounds, such as bleach, muriatic acid, decalcifying agents. Do not use abrasive sponges or wire wools that may scratch the surface or leave rust stains.

### CHROMIUM-PLATED STAINLESS STEEL - AISI 304 - DIN 1.4301 (profilpas design)

It has a refined aesthetic value. It is suitable for wall coverings but not for floors: the cleaning maintenance should be done with sponges or soft and non-abrasive cloths. We suggest to use neutral detergents.

### Rigid PVC

Vinyl compound of rigid PVC unleaded, anti shock, non-flammable. Mixture eco-friendly with Ca-Zn salts.

### Plasticized PVC

Vinyl compound of plasticized PVC unleaded, non-flammable. Mixture eco-friendly with Ca-Zn salts.

### Foam PVC

Vinyl compound of plasticized PVC unleaded, non-flammable. Mixture eco-friendly with Ca-Zn salts.

### Co-extruded PVC - Rigid/Rigid

Vinyl compound of rigid PVC unleaded, anti-shock non-flammable. Mixture eco-friendly with Ca-Zn salts.

### Co-extruded PVC - Plasticized/Plasticized

Vinyl compound of plasticized PVC unleaded, non-flammable. Mixture eco-friendly with Ca-Zn salts.

### Co-extruded PVC - Rigid/Plasticized

Vinyl compound of rigid PVC unleaded, anti-shock, non-flammable. Mixture eco-friendly with Ca-Zn salts. Vinyl compound of plasticized PVC unleaded, non-flammable. Mixture eco-friendly with Ca-Zn salts.

### Co-extruded PVC - Rigid/Plasticized anti-mould

Vinyl compound of rigid PVC unleaded, anti-shock, non-flammable. Mixture eco-friendly with Ca-Zn salts. Vinyl compound of plasticized PVC unleaded, non-flammable, addicted with biocide. Mixture eco-friendly with Ca-Zn salts.

### Co-extruded PVC - Foam/Plasticized

Vinyl compound of foam PVC unleaded, non-flammable. Mixture eco-friendly with Ca-Zn salts. Vinyl compound of plasticized PVC unleaded, non-flammable. Mixture eco-friendly with Ca-Zn salts.

## ADVICES FOR CLEANING AND MAINTENANCE

MATERIAL	FINISHING	CLEANING AFTER LAYING	MAINTENANCE
aluminium	anodised	Use of acid based cleaners and not alkaline	exclusive use of neutral cleaning products
aluminium	bril. polished	Use of acid based cleaners and not alkaline	exclusive use of neutral cleaning products
aluminium	bright polished copper	Use of acid based cleaners and not alkaline	exclusive use of neutral cleaning products
aluminium	bright polished titanium	Use of acid based cleaners and not alkaline	exclusive use of neutral cleaning products
aluminium	bright polished gold	Use of acid based cleaners and not alkaline	Exclusive use of neutral cleaning products
aluminium	color-coated	Use of acid based cleaners	use neutral or alkaline detergents
aluminium	bright satin	Use of acid based cleaners and not alkaline	exclusive use of neutral cleaning products
aluminium	riv. Alcrom Plus	Use of acid based cleaners	Exclusive use of neutral cleaning products
stainless steel	polished	Use of acid based cleaners without chlorine	use neutral or alkaline detergents
stainless steel	Inox AISI 316	Use of acid based cleaners	exclusive use of neutral cleaning products
stainless steel	sandblast	Use of acid based cleaners only neutral	use neutral or alkaline detergents
stainless steel	satin	Use of acid based cleaners without chlorine	use neutral or alkaline detergents
brass	natural	Use of acid based cleaners only neutral	exclusive use of neutral cleaning products
brass	polished	Use of acid based cleaners only neutral	exclusive use of neutral cleaning products
brass	chromium - plated	Use of acid based cleaners	use neutral or alkaline detergents
PVC		Use of acid based cleaners and not alkaline	exclusive use of neutral cleaning products

## PROFILES CHARACTERISTICS AND PACKAGING

### SELF-ADHESIVE PROFILES

Self-adhesive profiles are made of non-toxic, non-flammable and solvent free hot-melt glues. Although these products are non-flammable, it is recommended not to expose them to naked flames. Product preservation is guaranteed when stored in "normal" climatic conditions.

Glue deteriorates at temperatures over +90°C and crystallizes at temperatures below -15°C. During the application, the temperature of self-adhesive profiles and the ambient temperature where profiles have to be laid should not be below +10°C.

Important: self-adhesive profiles cannot be laid on friable supports, as junction between two carpet floors or between PVC floors and wall coverings.

### DRILLED PROFILES

Screw-mounted profiles are drilled according to the model and the material at issue, so that to lodge 3 mm or 3,5 mm screws, either flat-head or round-head ones.

### PACKAGING

The  means blister packaging.

"Individually packed" means that the packaging is made for the single profile with a protective heat shrink film.

### MEASURES - TOLERANCES - REFERENCES NORMS - CERTIFICATION ON PRODUCT

Please note that the information and the drawings in the present catalogue are not binding.

The data about measures, such as length, thickness and width refer to nominal measures. The foreseen tolerances, the related norms and reference certifications are indicated in the specifications of products, available on request.

### DIRECTIONS

The resistance to chemical products depends on their degree of chemical aggressiveness and therefore it is necessary to make sure in advance of the effects that products used for profile laying, cleaning and maintenance can produce. In particular lime, mortar or tile glue cause strains on the visible surface of profiles. Therefore it is necessary to clean these parts immediately after the laying of the profiles. Please note that in the present catalogue, due to the printing, the colour shades can be slightly different from the real ones.

## GENERAL CONDITIONS OF SALE

These General Conditions shall govern all sales contracts executed between Profilpas S.p.A. and the Buyer and shall prevail on all the Buyer's general or individual purchasing conditions. Any derogation to these General Conditions shall be binding on Profilpas only if accepted in writing by the latter.

### 1. Prices

The prices shown in Profilpas' price list are in Euro per meter but products will be invoiced in Euro per piece with the discounts granted in accordance with the ordered quantities or upon agreement with Profilpas. Prices are exclusive of additional taxes or customs duties. Profilpas expressly reserves the right to modify the prices without notice, in accordance with any fluctuation in the costs of raw materials.

### 2. Minimum orders

The required minimum order value is fixed at the amount of Euro 500,00.

### 3. Orders

Purchase orders must be sent in writing. Orders shall be deemed accepted and binding on Profilpas only after receipt by the Buyer of Profilpas' written order confirmation. Only the discounts and the prices indicated in the order confirmation shall be binding for Profilpas. Should the order confirmation contain amendments with respect to the Order, such amendments shall be deemed tacitly accepted by the Buyer after 5 (five) days from receipt of the order confirmation unless the Buyer notifies its disagreement in writing within the above-mentioned term.

### 4. Delivery terms

Deliveries shall be made EX WORKS (Incoterms 2010) Profilpas warehouse in Cadoneghe (Padova) - Italy. The products shall always be transported at the Buyer's risk according to the Incoterms, and any reimbursements for damages shall be claimed by the Buyer to the carrier in accordance with the relevant agreements and clauses contained in the stipulated insurance policies. Delivery dates are estimated and not guaranteed. Profilpas shall not be responsible for any delay nor for the consequences thereof. In case of delay in delivery, the Buyer shall not have the right to terminate the sales agreement and/or obtain compensation of any direct, indirect or consequential damage suffered, unless in case of intent or gross negligence.

### 5. Packaging

Prices include Profilpas standard packaging. Sea shipment packaging or any other special packaging requested by the Buyer will be charged at cost. Profilpas' catalogue indicates which products have partial packaging and the surcharge applied in such case. In case of products without partial packaging, Profilpas can exceptionally sell them with partial packaging, charging the price on the pricelist without discount.

### 6. Terms of payment

All payments must be made in accordance with the agreed terms of payment; the relevant sums must be transferred to the bank indicated by Profilpas. In case of delay of payment, whether total or partial, the Buyer shall be bound to pay interest on all outstanding amounts calculated according to art. 5 of Italian Legislative Decree no. 231/2002 or subsequent modifications.

Delay or non-payment of any sums due by the Buyer to Profilpas, even if concerning different contractual relationships, shall entitle Profilpas to suspend the preparation and delivery of the products which are the object of the order and of any other order in progress.

### 7. Claims

Claims must be notified in writing to Profilpas within 10 days from the delivery date. Claims for damaged, stolen or missing products shall be lodged with the carrier upon receipt of the products. If no written

complaint is lodged with the carrier, Profilpas will not accept any return or replacement of the delivered products. Return of products will only be accepted upon Profilpas' prior written consent and always at the Buyer's expense.

### 8. Retention of title (article 1523 of the Italian Civil Code)

The products shall remain the property of Profilpas until full payment. Non-compliance, or partial compliance, of the agreed payment terms allow Profilpas, without prejudice to any other claim it may have, to recover the products supplied, even if transferred to third parties. The Buyer is liable for any damage to the products due to poor storage or negligence and shall be responsible as a depositary. Profilpas does not assume responsibility for damage to the products consequential or subsequent to the installation of the same.

### 9. Warranty and defects

Profilpas guarantees that the products are free from defects in material and workmanship for a period of 12 months from the date of delivery to the Buyer. Should Profilpas acknowledge the existence of the claimed defects, and provided that it has been promptly notified in accordance with the above mentioned paragraph "Claims", Profilpas' warranty shall be limited, at its discretion, to the replacement of the defective products, free of charge EXW Profilpas' premises (Incoterms 2010), within the normal time required therefor, or to the issue of a credit note for the amount of the defective products, ANY OTHER LEGAL OR CONVENTIONAL WARRANTY OR CLAIMS FOR ANY FURTHER DIRECT, INDIRECT OR CONSEQUENTIAL DAMAGES SUSTAINED BY THE BUYER OR THIRD PARTIES, UNLESS IN CASE OF INTENT OR GROSS NEGLIGENCE, BEING EXPRESSLY EXCLUDED.

The Buyer expressly waives its right of regress according to article 131 of the Italian Consumers' Code.

No products will be returned by the Buyer without prior written permission by Profilpas. Profilpas does not guarantee the compliance of the products to any particular specifications or technical characteristics or their suitability for any use and/or special uses if not to the extent that such characteristics have been expressly agreed in the sales contract. Profilpas is not liable for damages that the Buyer, or third parties, generate by using the products if the damage does not depend on the quality or intrinsic characteristics of the product, but by the choice of purchase and usage of the same by the Buyer.

### 10. Industrial and intellectual property

Profilpas Spa's trademarks, distinguishing signs, designs, photographs of products and/or production and commercial technology shall be considered strictly confidential and shall not be used without prior written authorisation from the same.

### 11. Express delivery

Upon the Buyer's request, Profilpas can offer a service of express delivery. The surcharge for this express service will be communicated with the order confirmation.

### 12. Privacy

Personal and fiscal details which may be acquired directly by Profilpas spa (Via Einstein 38 – Cadoneghe), the data controller, or via third parties, shall be used for contractual purposes, pursuant to law, to manage business relations and promote sales. Said data may be communicated to third parties both in Italy and abroad such as Profilpas spa's network of sales representatives, financial institutions, factoring companies, insurance, debt recovery and business information companies as well as professionals, management consultants and carriers.

### 13. Final clauses

Profilpas sales are governed by the laws of Italy.

In case of dispute, the courts of Padua – Italy shall be the exclusive competent venue.





<b>020/</b>	106	<b>88/6E</b>	206 - 237	<b>97/8I</b>	213
<b>023/</b>	109	<b>89/</b>	202 - 203	<b>97/8P</b>	213
<b>024/</b>	109	<b>89/ EI</b>	202 - 203	<b>97/8SF</b>	213
<b>026/</b>	107	<b>89/ TM</b>	202	<b>98/7E</b>	210
<b>030/</b>	109	<b>89/ TMEI</b>	202	<b>98/7G</b>	210
<b>040/</b>	109	<b>89/6L</b>	203 - 238	<b>98/7I</b>	210
<b>050/</b>	133	<b>89/6EI</b>	203 - 238	<b>98/7P</b>	210
<b>060/</b>	133	<b>89/6I3</b>	204	<b>98/7SF</b>	210
<b>076/</b>	44	<b>89/6I3EI</b>	204	<b>99/M</b>	104
<b>080/</b>	133	<b>89H/</b>	202	<b>99/R/</b>	104
<b>0100/</b>	133	<b>89H/ EI</b>	202	<b>99/T/</b>	102 - 189
<b>6/</b>	119	<b>90/ A</b>	198	<b>99/TR/26</b>	102 - 189
<b>10/</b>	119	<b>90/ E</b>	199	<b>100/</b>	208
<b>10/15</b>	255	<b>90/ G</b>	199	<b>101/74</b>	208
<b>19/</b>	108	<b>90/ I</b>	199	<b>105/7</b>	205
<b>21/</b>	105	<b>90/ MI</b>	199	<b>105/7E</b>	205
<b>22/A</b>	108 - 182 - 183	<b>90/ ME</b>	199	<b>105/7G</b>	205
<b>25/</b>	108	<b>90/ MG</b>	199	<b>105/7I</b>	205
<b>25/37/4</b>	249	<b>90/ MP</b>	199	<b>105/7P</b>	205
<b>25/37/B</b>	251 - 253	<b>90/ P</b>	199	<b>105/CB</b>	205
<b>30/</b>	105	<b>90/ SF</b>	198	<b>110/</b>	160
<b>35/</b>	105	<b>90/ SSF</b>	198	<b>111/ /F</b>	157 - 190
<b>37/61/4</b>	249	<b>90/ TMSF</b>	198	<b>124/</b>	160
<b>37/61/B</b>	251 - 253	<b>90/ TSF</b>	198	<b>125/</b>	162
<b>41/</b>	105	<b>90H/6ME</b>	198	<b>126/</b>	161
<b>45/</b>	114	<b>90H/6MG</b>	198	<b>126/L/F</b>	235
<b>46/</b>	119	<b>90H/6MI</b>	198	<b>126/LP/DX</b>	235
<b>50/A</b>	182 - 183	<b>90H/6MP</b>	198	<b>126/LP/SX</b>	235
<b>54/</b>	119	<b>90H/6SF</b>	198	<b>130/</b>	159
<b>55/</b>	116	<b>92/7</b>	201	<b>148/B</b>	226
<b>57/</b>	116	<b>93/</b>	201	<b>148/C</b>	226
<b>58/</b>	158 - 184	<b>94/169/4</b>	249	<b>150</b>	164
<b>60/105/4</b>	249	<b>94/169/B</b>	251 - 253	<b>150/</b>	168
<b>60/105/B</b>	251 - 253	<b>95/ E</b>	209	<b>150/280/4</b>	249
<b>61/</b>	116	<b>95/ G</b>	209	<b>150/280/B</b>	251 - 253
<b>63/A</b>	182 - 183	<b>95/ I</b>	209	<b>151</b>	164
<b>70/</b>	159	<b>95/ P</b>	209	<b>151/11</b>	168
<b>71/</b>	159	<b>95/ SF</b>	209	<b>152</b>	164
<b>72/</b>	162	<b>97/4E</b>	211	<b>154</b>	165
<b>73/</b>	158 - 184	<b>97/4G</b>	211	<b>155</b>	165
<b>74/</b>	158 - 184	<b>97/4I</b>	211	<b>155/16</b>	168
<b>75/F</b>	157 - 190	<b>97/4P</b>	211	<b>156</b>	165
<b>76/</b>	160	<b>97/4SF</b>	211	<b>161/11</b>	169
<b>78/</b>	163	<b>97/7E</b>	212	<b>163/</b>	168
<b>79/</b>	162	<b>97/7G</b>	212	<b>168/16</b>	169
<b>80/</b>	161	<b>97/7I</b>	212	<b>169</b>	227
<b>87/</b>	158	<b>97/7P</b>	212	<b>169/</b>	169
<b>87/6</b>	206 - 237	<b>97/7SF</b>	212	<b>170</b>	227
<b>88/6</b>	206 - 237	<b>97/8CB</b>	213	<b>170/</b>	169
<b>88/16SF</b>	206	<b>97/8E</b>	213	<b>171</b>	227
<b>88/16L/A</b>	206 - 237	<b>97/8G</b>	213	<b>171/11</b>	169

172	226	740/	109	8582	222
173	226	750/	133	8596	222
174/	169	760/	133	8598	222
175/11	169	774/	43	8600	221
177/16	169	775/	43	8602	223
178/16	169	776/	43	8602/C	211 - 223 - 224 - 225
210/	42	777/	43	8602/E	223
210H/A	42	779/SF	43	8602/I	223
220/	42	780/	133	8602/P dx/sx	223
239/320/4	249	790/ ME	200	8603	224
239/320/B	251 - 253	790/ MES	200	8603/E	224
277/	42	790/ MG	200	8603/G	224
300/	118	790/ MGS	200	8603/I	224
311/	117	790/ MI	200	8603/P dx/sx	224
312/	117	790/ MIS	200	8605	216
370/	158	790/ MP	200	8606	216
373/	158	790/ MPS	200	8607	225
380/8	101	790/ SF	200	8607/E	225
399/10	104	799/	101	8607/G	225
399/M	104	799/T/	103	8607/I	225
399/R/	104	799/TS/	103	8607/P dx/sx	225
399/T/	103 - 189	799/U/	101	8608	217
399/TC/	103 - 189	4020/	106	8608/C	201 - 217 - 219
399/U	101	4026/	107	8610	45
419/	108	4030/	109	8611	45
422/AD	108 - 182 - 183	4050/	133	8612/10	220
425/	108	4060/	133	8613	219
430/	105	4080/	133	8614	220
441/	105	4150/11/S	168	8615	218
450/AD	182 - 183	4170/ /S	169	8616	218
455/	116	4300/	118	30046	267
457/	116	4311/	117	30049	267
461/	116	4312/	117	30052	267
470/	159	4399/R/10	104	AF/1	51 - 207
473/	158	4399/T	103	AI/	28 - 96 - 191
474/	158	4701/	118	AI/ /E	28
476/	160	4711/	117	AIF/	98
487/	158	4712/	117	AIL/	28
499/T	102	4720/	106	AIP/	28
700/	118	4722/	106	AIS/	28 - 96
701/	118	4726/	107	AIS/ /E	28
711/	117	4729/	107	AIX/	28 - 96
712/	117	4730/	109	AL/120/24	240
720/	106	4750/	133	AL/150/24	240
722/	106	4760/	133	AL/60/24	240
723/	109	4780/	133	AL/90/24	240
724/	109	4799/T	103	AX/2/	41
726/	107	4799/TS	103	BH/20	93
729/	107	7100/	133	BH/20/A	93
730/	109	8181	221	BI/40	63
732/SF/	118 - 185	8580	222	BI/40/A	63

<b>BL/</b>	62	<b>CPEV/45/ /E</b>	147	<b>DJN/</b>	99
<b>BLA/</b>	62	<b>CPEV/45/ /G</b>	147	<b>DJN/ /EI</b>	99
<b>BLAH/</b>	62	<b>CPEV/72/</b>	146	<b>DJNF/</b>	99
<b>BP/20</b>	93	<b>CPEV/72/ /E</b>	147	<b>DT1</b>	265
<b>BP/20/A</b>	93	<b>CPEV/72/ /G</b>	147	<b>DT10</b>	265
<b>BP/22</b>	92	<b>CPGV/55/</b>	144	<b>DT2</b>	265
<b>BP/25</b>	92	<b>CPGV/55/ /E</b>	144	<b>DT3</b>	265
<b>BPK/20</b>	93	<b>CPGV/55/ /G</b>	144	<b>DT4</b>	265
<b>BPK/25</b>	92	<b>CPHA/</b>	148	<b>DT5</b>	265
<b>BPT/20</b>	93	<b>CPHV/</b>	148	<b>DT7</b>	265
<b>BPT/22</b>	92	<b>CPHA/ /E</b>	148	<b>FIX/J/30</b>	187
<b>BPT/25</b>	92	<b>CPHV/ /E</b>	148	<b>FIX/J/44</b>	186
<b>C/10/SF</b>	176	<b>CPLB</b>	149 - 257	<b>FIX/L/32</b>	187
<b>C/13/SF</b>	176	<b>CPLB/2</b>	149 - 257	<b>FIX/L/55</b>	186
<b>C/22/SF</b>	176	<b>CPLV/</b>	149 - 257	<b>FIX/T/19</b>	187
<b>C/4</b>	180	<b>CPLV/ /E</b>	149 - 257	<b>FIX/T/33</b>	186
<b>C/7/SF</b>	174 - 175	<b>CPLV/ /G</b>	149 - 257	<b>FL/C</b>	262
<b>CE/10/100</b>	241	<b>CPNV/45/</b>	143	<b>FMA/</b>	40
<b>CE/10/20</b>	241	<b>CPNV/45/ /E</b>	143	<b>FMAC/</b>	40
<b>CE/5/20</b>	241	<b>CPNV/45/ /G</b>	143	<b>FMAE/</b>	40
<b>CE/RGB/20</b>	241	<b>CPNVF/45/</b>	143	<b>FMAI/</b>	40
<b>CLA/</b>	231	<b>CPQV/50/</b>	145	<b>FMB/</b>	40
<b>CLA/8A</b>	231	<b>CPQV/50/ /E</b>	145	<b>FMBC/</b>	40
<b>CLA/8P</b>	231	<b>CPQV/50/G</b>	145	<b>FMBE/</b>	40
<b>CN28</b>	265	<b>CPQV/70/</b>	145	<b>FMBI/</b>	40
<b>CPCI/55/</b>	140	<b>CPQV/70/ /E</b>	145	<b>FMI/</b>	40
<b>CPCI/55/ /E</b>	141	<b>CPQV/70/G</b>	145	<b>FMIC/</b>	40
<b>CPCI/55/ /G</b>	141	<b>CR/N</b>	256	<b>FMICS/</b>	40
<b>CPCI/75/</b>	140	<b>D/4461/K</b>	266	<b>FMIE/</b>	40
<b>CPCI/75/ /E</b>	141	<b>D/4471/K</b>	266	<b>FMIES/</b>	40
<b>CPCI/75/ /G</b>	141	<b>DC1</b>	265	<b>FMII/</b>	40
<b>CPCI/95/</b>	140	<b>DC10</b>	265	<b>FMIIS/</b>	40
<b>CPCI/95/ /E</b>	141	<b>DC2</b>	265	<b>FMIS/</b>	40
<b>CPCI/95/ /G</b>	141	<b>DC3</b>	265	<b>G/2/SF</b>	178
<b>CPCV/30/</b>	142	<b>DC4</b>	265	<b>G/4/SF</b>	179
<b>CPCV/30/ /E</b>	142	<b>DC5</b>	265	<b>G/40/</b>	132
<b>CPCV/30/ /G</b>	142	<b>DC7</b>	265	<b>G/460/</b>	132
<b>CPCV/55/</b>	140	<b>DCE4</b>	263	<b>G/60/</b>	132
<b>CPCV/55/ /E</b>	141	<b>DF</b>	264	<b>G/705/F</b>	190
<b>CPCV/55/ /G</b>	141	<b>DI/</b>	99	<b>G/80/</b>	132
<b>CPCV/75/</b>	140	<b>DIMM/02</b>	240	<b>G/9/F</b>	234
<b>CPCV/75/ /E</b>	141	<b>DJA/</b>	99	<b>G/9P/DX</b>	234
<b>CPCV/75/ /G</b>	141	<b>DJA/ /EI</b>	99	<b>G/9P/SX</b>	234
<b>CPCV/95/</b>	140	<b>DJAF/</b>	99	<b>GA/</b>	56 - 192
<b>CPCV/95/ /E</b>	141	<b>DJG/</b>	99	<b>GAN/</b>	57
<b>CPCV/95/ /G</b>	141	<b>DJG/ /EI</b>	99	<b>GBL/ /C</b>	62
<b>CPCVF/55/</b>	140	<b>DJK/</b>	99	<b>GBL/ /E</b>	62
<b>CPEI/45/</b>	146	<b>DJK/ /EI</b>	99	<b>GBL/ /I</b>	62
<b>CPEI/45/ /E</b>	147	<b>DJKC/10</b>	52	<b>GBL/ /T</b>	62
<b>CPEI/45/ /G</b>	147	<b>DJKG/10</b>	53	<b>GF/</b>	159
<b>CPEV/45/</b>	146	<b>DJKGC/10</b>	53	<b>GG/2</b>	82

GG/3	82	GTINX/I	58	L5/WW/33	240
GG/4	82	GTINX/T	58	L5/WW/67	240
GIC/	60	GTL/C	63	LA/I/	50
GIN/	58	GTL/E	63	LA/IS/	50
GIN/ /SA	58	GTL/I	63	LB/A	50
GINS/	58	GTL/T	63	LB/B/	50
GINS/ /SA	58	GTP/C	57 - 59	LDA/	50
GINX/	58	GTP/E	57 - 59	LDAD	51
GINX/ /SA	58	GTP/I	57 - 59	LDAG/	50
GJA/	131	GTP/T	57 - 59	LDB/	50
GJF/	131	GTV/E	56	LDRS/	50
GJS/10	131	GTV/I	56	LDS/	50
GM12/L	125	GU/30/	89	LDT/	50
GM/10	125	GU/40/	89	LDTM/	50
GM/72	162	GV/	56	LDV/	50
GM/78	163	GVNH/	57	LLA/20	230
GM/I	124	GWA/	131	LLA/20P	230
GM/R	162	H3502	166	LLA/20/10	230
GMP/I	124	H/5/F	189	LLA/30	230
GMR/44	161 - 235	IL/	46	LLA/30P	230
GP/	59	ILN/	46	LLB/30	230
GPS/6	82 - 83	ILNS/	46	LLB/30P	230
GPS1/ /19	82	ILNX/	46	LQL/2	232
GPS14/12	83	IP/40	44	MIN/	41 - 115
GPS2/	83	IPA/	31 - 153	NAN/	124
GPS3/ /10	84 - 85	IPB/	31 - 153	NE/	122
GPS3/ /11	84 - 85	IPV/	31	NF/	123
GPS3/ /12	84 - 85	IR/C01	241	NIL/	125
GPS4/ /10	86 - 87	IR/C01NT	241	NIN/	125
GPS4/ /11	86 - 87	IR/C02	241	NJ/	122
GPS4/ /12	86 - 87	IR/C03	241	NL/	123
GPS5/10/	88	IR/W3	241	NPAN/	124
GPS5/11/	88	JGA/	192	NTA/	126 - 188
GPS5/12/	88	K10	266	NTI/	126 - 188
GPU/	59	KL/1	262 - 263	NTO/	126
GR/80/	132	KL/1A	262 - 263	NZA/	127 - 188
GTA/E	56	KL/2	262 - 263	NZS/	127
GTA/I	56	KL/3	262 - 263	NZS/A/40	127
GTIN/C	58	KL/C	263	NZS/B/	112
GTIN/E	58	KL/T1	262	NZS/L/	127
GTIN/G	58	KL/T2	262	NZS/S1	112
GTIN/I	58	KL/T3	262	NZS/S2	112
GTIN/T	58	KL/X1	262	P/5	255
GTINS/C	58	KL/X2	262	P1/10	249 - 251 - 253 - 254 - 256
GTINS/E	58	KL/X3	262	P1/80	249 - 251 - 253
GTINS/G	58	L5/NW/33	240	PA/	113
GTINS/I	58	L5/NW/65NT	240	PAE	90 - 136
GTINS/T	58	L5/NW/67	240	PAI	90 - 136
GTINX/C	58	L5/NW/67NT	240	PAIG/ /15	91 - 136
GTINX/E	58	L5/NW/67NT	240	PAIG/ /20	91 - 136
GTINX/G	58	L5/RGB/67	240	PAIG/ /28	91 - 136

<b>PAIG/ /38</b>	91 - 136	<b>PT/6</b>	181	<b>RR/5</b>	266
<b>PAS/</b>	129	<b>PT/6/SA</b>	181	<b>RT/</b>	32
<b>POLISHING PASTE</b>	266	<b>PTC</b>	261	<b>RTM/</b>	32
<b>PB30</b>	90 - 136	<b>PTC/3000</b>	261	<b>RV/</b>	32
<b>PB5</b>	90 - 136	<b>PTC1</b>	261	<b>RVH/</b>	32
<b>PBA/</b>	114	<b>PTC1/3000</b>	261	<b>S/15/SF</b>	176
<b>PBA/5/A</b>	188	<b>PTC1A</b>	261	<b>S/4</b>	180
<b>PBAS/5/F</b>	189	<b>PTC1A/3000</b>	261	<b>S/9/SF</b>	174 - 175
<b>PBE/</b>	128	<b>PTC2</b>	261	<b>S/95</b>	201 - 209 - 210 - 212
<b>PBE30</b>	137	<b>PTC2/3000</b>	261	<b>S/97</b>	213
<b>PBE5</b>	137	<b>PTC3</b>	261	<b>SA/</b>	157
<b>PBH/</b>	129	<b>PTC3/3000</b>	261	<b>SA/G</b>	157
<b>PCC/01</b>	256	<b>PTC4</b>	261	<b>SAFETY-STEP</b>	166 - 167
<b>PCC/02</b>	256	<b>PTLN</b>	261	<b>SAR/10/12</b>	154
<b>PCC/03</b>	256	<b>PTS</b>	261	<b>SAR/8/15</b>	154
<b>PCC/04</b>	256	<b>PTWN</b>	261	<b>SB/</b>	157
<b>PCC/05</b>	256	<b>PTWN/1400</b>	261	<b>SB/G</b>	157
<b>PF12</b>	90 - 136	<b>PV/</b>	30	<b>SFL</b>	262
<b>PFFE/</b>	130	<b>PWD12</b>	137	<b>SGA/</b>	152
<b>PHDE/</b>	130	<b>PWP30</b>	137	<b>SGA/11L</b>	234
<b>PI/</b>	61	<b>QDC/1010</b>	79	<b>SGA/11P</b>	234
<b>PIA/</b>	61 - 192	<b>QDCC/1010</b>	79	<b>SGI/</b>	152
<b>PIN/</b>	60	<b>QDI/1010</b>	79	<b>SGK/</b>	152
<b>PLAF/</b>	115	<b>QDL/1010</b>	79	<b>SGN/</b>	152
<b>PN/</b>	113	<b>RA/</b>	32 - 191	<b>SIR/10/12</b>	154
<b>PNI/</b>	113	<b>RAS/</b>	32	<b>SIR/8/15</b>	154
<b>PNIS/</b>	113	<b>RB/</b>	32	<b>SIRS/10/12</b>	154
<b>PP/</b>	68	<b>RC/ /F</b>	185	<b>SIRS/8/15</b>	154
<b>PP50/</b>	68	<b>RC/411/CV</b>	185	<b>SIS/</b>	155
<b>PP/96</b>	93 - 137 - 208 - 226 - 266	<b>RC/415/CV</b>	185	<b>SIS/10/SF</b>	155
<b>PPL/5030/T</b>	250	<b>RC/47/CV</b>	185	<b>SIX/</b>	155
<b>PPL/D4</b>	253	<b>RC/49/CV</b>	185	<b>SKL/2</b>	207 - 236
<b>PPL/DLB</b>	256	<b>RC/5/F</b>	189	<b>SLIM/</b>	75
<b>PPL/DLT</b>	256	<b>RCF/</b>	185	<b>SLIM-I/</b>	75
<b>PPL/GM</b>	253	<b>RE/</b>	38	<b>SM/</b>	152
<b>PPL/GR</b>	253	<b>REC/ /100</b>	39	<b>SMA/</b>	152 - 190
<b>PPL/S</b>	256	<b>RECO/ /80</b>	39	<b>SMART/</b>	77
<b>PPL/T</b>	253	<b>RI/</b>	34 - 191	<b>SMART3/</b>	77
<b>PPL/TA</b>	253	<b>RIC/01</b>	240	<b>SMART-I/</b>	77
<b>PPL/TD</b>	250	<b>RIC/RGB/M</b>	240	<b>SN/</b>	153
<b>PPL/TD/GR</b>	250	<b>RIC/RGB/S</b>	240	<b>SNG/</b>	153
<b>PPL/TD/TT</b>	250	<b>RIL/</b>	34	<b>SP/</b>	156
<b>PPL/T2</b>	251	<b>RIN/</b>	35	<b>SP1</b>	255
<b>PPL/T3</b>	251	<b>RINS/</b>	35	<b>SP2</b>	255
<b>PPL/T4</b>	251	<b>RINX/</b>	35	<b>SP3</b>	255
<b>PPL/TT</b>	253	<b>RIP/</b>	34	<b>SS/4</b>	266
<b>PR30</b>	90 - 136	<b>RIS/</b>	34	<b>SS/5</b>	266
<b>PR5</b>	90 - 136	<b>RIX/</b>	34	<b>ST/7</b>	126
<b>PROFLEX MACHINE</b>	267	<b>RKN/</b>	36	<b>STA/</b>	126
<b>PT/4</b>	181	<b>RLN/</b>	36	<b>STI/</b>	126
<b>PT/4/SA</b>	181	<b>RPA/</b>	37	<b>STO/</b>	126

SWA/	156	TPC/47/CV	177	ZK/	29 - 96
SWB/	156	TPS/410/CV	177	ZN/	96
T/	175 - 176	TPS/413/CV	177	ZNF/	98
TA/	33	TPS/47/CV	177	ZQAGN/	18
TAS/	33	TPU/	175 - 176 - 178 - 179	ZQAGN/ /EI	19
TAT/	33	TPZ/410/CV	177	ZQAL/10	233
TATM/	33	TPZ/413/CV	177	ZQAL/10B	233
TB/	33	TPZ/47/CV	177	ZQAL/10P	233
TE/	38	TU/6	175 - 176 - 178 - 179	ZQAN/	18 - 191
TEI/	38	TV/	33	ZQAN/ /EI	19
TEL/04	240	UA/	100	ZQAND/	22
TEL/RGB/04	240	UA/ /EI	100	ZQAND/ /EI	22
TGU/	89	UG/	100	ZQBN/	18
THIN/	73	UG/ /EI	100	ZQBN/ /EI	19
TIA/	33	UI/	100	ZQBRSN/	18
TIAS/	33	UI/ /EI	100	ZQBRSN/ /EI	19
TIAT/	33	UIS/	100	ZQBSN/	18
TIB/	33	UIS/ /EI	100	ZQBSN/ /EI	19
TIE/	34	UK/	100	ZQIM/ /EI	23
TIEL/	34	UK/ /EI	100	ZQIMP/ /EI	23
TIEN/	35	UKC/10	52	ZQIMS/ /EI	23
TIENS/	35	UKG/10	53	ZQIN/	23
TIENX/	35	UKGC/10	53	ZQIN/ /EI	23
TIEP/	34	UN/	100	ZQINP/	23
TIES/	34	UN/ /EI	100	ZQINP/ /EI	23
TIEX/	34	VITI	266	ZQINS/	23
TII/	34	XLC/	77	ZQINS/ /EI	23
TIIL/	34	XLC3/	77	ZQINX/	23
TIIN/	35	XLCC/	77	ZQINX/ /EI	23
TIINS/	35	XLL/	77	ZQKN/	24 - 191
TIINX/	35	XPC/	69	ZQKN/ /EI	24
TIIP/	34	XPD/	71	ZQLN/	24
TIIS/	34	XPF/	70	ZQLN/ /EI	24
TIIX/	34	XPI/	71	ZQP/	25
TIME/	35	XSC/	75	ZQP/ /EI	25
TIMI/	35	XSCC/	75	ZQTMN/	18
TIV/	33	XSL/	75	ZQTMN/ /EI	19
TLA/10/C1	231	XTC/	73	ZQTN/	18
TLA/10P/C1	231	XTCC/	73	ZQTN/ /EI	19
TLB/10/C1	231	XTL/	73	ZQVN/	18 - 20
TLB/10P/C1	231	XTT/	73	ZQVN/ /EI	19 - 21
TOP/ /E	47	Z/1/SF	174 - 175	ZQVNH/	18
TOP/ /ETM	47	Z/4	180	ZTM/	26
TOP/ /I	47	Z3/30/SF	176	ZV/	26 - 27
TOP/ /ITM	47	ZA/	26 - 96 - 191	ZVH/	26
TOP/A/	47	ZB/	26		
TOP/TM/	47	ZBG/	97		
TPAE/	37	ZBGF/	98		
TPAI/	37	ZBS/	26		
TPC/410/CV	177	ZG/	96		
TPC/413/CV	177	ZGF/	98 - 190		





























**Profilpas S.p.A.**

via Einstein, 38  
35010 Cadoneghe  
(Padova) Italy

tel. +39 049 8878412  
fax +39 049 706692

[info@profilpas.com](mailto:info@profilpas.com)  
[www.profilpas.com](http://www.profilpas.com)

